

# AB Technology Group Inc.

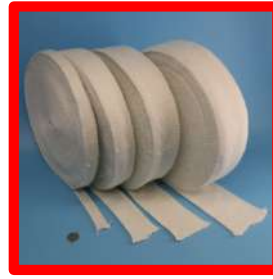

## - Wire, Cable, Hose, Equipment & Personnel Protection

- Thermal Protection Solutions for cold, heat, flame, fire, weld splatter and liquid metal exposure
- Abrasion Resistance & Organization Solutions
- Silicone & Ceramic Thermal Adhesives
- High Temperature Ceramics
- Equipment Covers and Blankets for Thermal Efficiency & Personnel Protection



- 1: SLEEVE / JACKET
  - 2: TAPE / TADPOLE
  - 3: ROPE / PACKING
  - 4: FABRIC / CLOTH
  - 5: INSULATION
  - 6: Abrasion Protection Sleeve & Spiral Wrap. Wire Organization Sleeve and Shrink Tube
  - 7: Custom Fabrications & Supplies
  - 8: Ceramic Materials Rod, Plate, Bar, Fasteners, Crucibles
  - 9: Silicone Rubber Tubing, Plugs, Extrusions, Heaters
  - 10: Fire Stop / Retardant Foams, Caulk, Mortar Putty & Spray Wire & Cable Transits
  11. Silicone & Ceramic Adhesives / Sealants Protective Coatings
  - 12: METAL FOILS
- Cross Reference Guides

Terms & Conditions  
Account Application Form

- Aerospace • Industrial • Commercial • Marine
- Military • Automotive • Bio-Pharma • Food
- Metal Processing • Mining • Petro-Chemical

Annual Catalogue # 23 / Rev Dec 2020  
Please visit our web site for the latest version of this catalogue



© Copyright 2001-2020 AB Technology Group. No part of this catalogue may be copied, reproduced or stored in an electronic retrieval system unless in its entirety, without alteration, modification or editing. All trade-marks and trade names are property of their respective owners.

A.B. Technology Group Inc. is ISO 9001: 2015 registered. Registration # 14136726



*Thermal Protection Solutions™*

*Serious Solutions. Serious Service™*

*Keeping Our World Cooler™*

## **Other Catalogues from A.B. Technology Group Inc.**

- **High Temperature Industrial Seals & Gaskets**  
Feb 2015
- **Uncured Silicone Adhesives Sealants & Coatings**  
Dec 2015

### **IMPORTANT NOTICE**

**Before using any product(s), you must evaluate it and determine if it is suitable for your intended application. You assume all risks and liability associated with such use.**

**With the exception of some silicone products designed for prosthetics, no product may be used for medical devices or instruments without our express consent.**

### **Warranty; Limited Remedy; Limited Liability.**

Product will be free from defects in material and manufacture at the time of purchase. **A/B Technology Group makes no other warranties including, but not limited to, any implied warranty of merchantability or fitness for a particular purpose.** If this product is defective within the warranty period stated above, your exclusive remedy shall be, at A/B Technology Group's option, to replace or repair the product or refund the purchase price of the product. **Except where prohibited by law, A/B Technology Group will not be liable for any indirect, special, incidental or consequential loss or damage arising from this product, regardless of the legal theory asserted.**

## Protection From:

Heat, Flame, Fire, Molten Splash, Weld Splatter, Grinding & Electrical Sparks, Infrared Radiant Heat, UV, Contamination, Abrasion & Harsh Chemicals

Providing Superior Protection for Hydraulic Hoses & Lines, Cables & Wires, Equipment & Personnel in Harsh and Extreme Environments

### Primary Materials

Fiberglass (Fibreglass) – Nomex – Kevlar - Basalt - Silica – Ceramic – Alumina - Silicone Rubber - PTFE (Teflon® is a branded version of PTFE from DuPont) – Expanded PTFE – Viton® - EPDM – Neoprene - Stainless Steel – Inconel – Bronze – Monel - Hastalloy

### Available Coatings

Vermiculite – PTFE – Viton® - Graphite – Silicone Rubber Elastomer – White Rubber - Acrylic Resin – Oleoresinous Varnish – Silicone Resin (Anti-Fray) - Aluminum & Stainless Steel (Heat Reflecting)  
Acrylic and Silicone Pressure Sensitive Adhesive (Self Adhesive)

### Finished Products

Sleeve – Tape – Fabric – Rope – Insulation - Gaskets & Seals  
Custom Fabricated Curtains – Blankets – Shields – Covers  
Tadpole Gaskets – Stove Gaskets - Oven Gaskets - Furnace Gaskets - Kiln Gaskets - Boiler Gaskets - Exhaust Duct Gaskets  
Ring & Face Gaskets – Slit and Machined Envelope Gaskets  
Silicone Electrical Strip Heaters  
Fire Retardant Fabric Spray  
Intumescent Firestop Paint & Coatings  
General Industrial Gaskets  
General Industrial Sheet Gasket and Packing – Compression Packings  
Custom Fabricated Removable Pipe and Exhaust Insulation Blankets  
Outdoor Non-Metallic Pipe Insulation & Protection Systems

*Products Proudly Made at USA & Canada Plants*

## Products

- ✓ **Silicone Rubber Coated Fiberglass High-Temperature Protection Materials**
- ✓ **High Temperature Silicone Rubber Adhesive, Sealant and End-Seal Dip**
- ✓ **Kevlar Protection Sleeve**
- ✓ **Nomex Protection Sleeve**
- ✓ **Very High-Temperature E-Type & S-Type Fiberglass Protection Materials**
- ✓ **Very High-Temperature Vermiculite Coated Protection Materials**
- ✓ **Extreme Temperature Silica Protection Materials**
- ✓ **Very High Temperature Graphite Coated Sleeve and Rope**
- ✓ **Extreme Temperature Plus Ceramic Fiber Protection Materials**
- ✓ **Radiant Heat Reflective Protection Materials**
- ✓ **High Temperature PTFE (Teflon® is a branded version of PTFE from DuPont) Coated Sleeve, Tape, Rope & Fabric**
- ✓ **High Temperature PTFE and ePTFE Ring and Full Face Gaskets**
- ✓ **High Temperature Slit PTFE Envelope Gaskets: TecPac™, TecBlue™, TecGraph™ Corrugated Steel, Stainless Steel, Neoprene or Viton fillers**
- ✓ **High Temperature Machined PTFE Envelope Gaskets: TecPac, TecBlue, Corrugated Steel, Stainless Steel, Neoprene or Viton fillers**
- ✓ **Abrasion, Wear and Blowout Protection Products for Hoses and Cables**
- ✓ **Stainless Steel Sleeve**
- ✓ **Mesh Rope Seals and Cores**
- ✓ **Very High Temperature & Extreme Temperature Custom Manufactured Blankets, Curtains, Shields & Covers. Welding Curtains, Blankets and pads.**
- ✓ **High Temperature Silicone Rubber Electrical Strip Heaters**
- ✓ **Fire Retardant Fabric Spray**
- ✓ **Intumescent Firestop Paint & Coatings**
- ✓ **General Industrial Gaskets**
- ✓ **General Industrial Sheet Gasket and Packing**
- ✓ **Compression Packings for Valves and Shafts**
- ✓ **Custom Fabricated Removable Pipe and Exhaust Insulation Blankets**
- ✓ **Outdoor Non-Metallic Pipe Insulation & Protection Systems**



## Catalog Contents

Item.....	Page
Catalogue Contents.....	i
Technical Notes.....	vii
Selecting Materials.....	x
How To Order.....	xi
<b>1. Sleeve / Jacket / Tubing / Hose - Ducting</b>	
<b>500°F / 260°C Firesleeve - Silicone Rubber Coated Fiberglass Sleeve / Tubing</b>	
FlameShield™ firesleeve – Industrial & Heavy Duty: .....	1-1
FlameShield™ firesleeve – AS1072 Aviation Aerospace Grade: .....	1-3
FlameShield™ firesleeve – AS1072 Aviation Aerospace Grade: Type 2 - Marked .....	1-4
FlameShield™ firesleeve – AS1072 Aviation Aerospace Grade: Type 2 - NSN/NATO .....	1-5
FlameShield™ firesleeve – DIN EN ISO 15540 Marine Grade .....	1-6
FlameShield™ firesleeve – MSHA IC-366/01 Mining Approved .....	1-7
FlameShield™ firesleeve – Technical Specifications .....	1-8
Firesleeve Accessories: End Seal Dip & End Seal Paste .....	1-9
Firesleeve Accessories: End Wrap Tape Meeting MIL-I-46852 / A-A-59163 .....	1-10
Firesleeve Accessories: Stainless Steel Clamps and Clamp Tool .....	1-11
<b>500°F / 260°C Firesleeve with Hook &amp; Loop Velcro® Closure</b>	
FlameShield™ HiFlex Firesleeve with Velcro Closure: .....	1-17
SplashGard™ LowFlex Firesleeve with Velcro Closure: .....	1-20
ZeusGard™ Aviation Firesleeve with Hook & Loop Velcro® Closure .....	1-23
<b>500°F / 260°C Firesleeve with Snaps / Zipper Closure</b>	
FlameShield™ firesleeve with Snap Closures: <i>Heavy Duty Removable Molten Splash Protection</i> .....	1-25
FlameShield™ firesleeve with Zipper Closures: <i>Heavy Duty Removable Molten Splash Protection</i> .....	1-27
<b>464°F / 240°C Silicone Rubber Coated Fiberglass Small Diameter AWG Wire Sized Sleeve</b>	
Small Diameter Thin-Wall Sleeve: <i>Silicone Rubber Coated Fiberglass Sleeve with UL/CSA rating NEMA TF-1</i> .....	1-29
<b>464°F / 240°C Silicone Rubber Coated Fiberglass Small Diameter AWG Wire Sized HD Sleeve</b>	
Small Diameter Heavy-Wall Sleeve: <i>Silicone Rubber Coated Fiberglass Sleeve with UL/CSA rating NEMA TF-1</i> .....	1-32
<b>266°F / 130°C Fiberglass Braided Hermetic AWG Small Diameter Sleeve – Acrylic Copolymer</b>	
Small Diameter AWG sized sleeve: .....	1-34
<b>266°F / 130°C Fiberglass Braided AWG Small Diameter Sleeve – Silicone Resin Binder</b>	
Small Diameter AWG sized sleeve: .....	1-36
<b>428°F / 220°C VITON® 231 Coated Fiberglass Small Diameter Sleeve</b>	
Small Diameter Thin-Wall Sleeve: <i>VITON® 231 Coated Fiberglass Sleeve with UL/CSA rating NEMA A1/B1/C1</i> .....	1-38
<b>392°F / 200°C StretchSleeve™ Silicone Rubber Coated Sleeve</b>	
Firesleeve with high elasticity: <i>Silicone Rubber Coated Fiberglass Sleeve with UL/CSA rating</i> .....	1-41
<b>550°F / 287°C DeltaGlass™ Fiberglass with PTFE Coating</b>	
Braided Fiberglass Sleeve with soft PTFE Coating .....	1-43
Specialty Sleeve with Velcro Closure: PTFE Resin Coated Fiberglass .....	1-45
<b>320°F / 160°C FlameShield™ Kevlar Aramid Braided Sleeve – Premium Grade</b>	
Kevlar Braided Aramid High Temperature, Heat & Flame Resistant Sleeve, Standard .....	1-47
Kevlar Braided Aramid High Temperature, Heat & Flame Resistant Sleeve, Heavy Wall .....	1-49
Kevlar Braided Aramid High Temperature, Heat & Flame Resistant Sleeve, Colored - Standard Wall .....	1-50
<b>460°F / 237°C FlameShield™ Silicone Closed Cell Foam Sleeve</b>	
Hose, Tubing and Pipe High Temperature Insulation Sleeve .....	1-52
<b>220°F / 104°C FlameShield™ EPDM Closed Cell Foam Sleeve</b>	
Hose, Tubing and Pipe High Temperature Insulation Sleeve .....	1-53
<b>662°F / 350°C FlameShield™ Nomex Braided Sleeve – Premium Grade</b>	
High Temperature, Heat & Flame Resistant Nomex® Sleeve .....	1-54
<b>662°F / 350°C FlameShield™ Nomex Split Sleeve Wrap</b>	
High Temperature, Heat & Flame Resistant Nomex® Split Sleeve Wrap .....	1-55

**1200°F / 648°C DeltaGlass™ Fiberglass – E Glass, S Glass**

Knitted Sleeve – Premium Grade .....	1-56
Braided Sleeve – Premium Grade .....	1-57
Braided Sleeve – Industrial Grade .....	1-58
Braided Heat Treated Sleeve – Premium Grade – Medium Size Range .....	1-59
Braided Sleeve – High Bulk Texturized .....	1-60
Braided Saturated Expandable Sleeve – Premium Grade .....	1-61

**1200°F / 648°C DeltaGlass™ AWG Sized Sleeve / Tubing**

Braided Sleeve: E-Glass Precision Small Diameter / Standard Wall: Heat Treated – w/Binders .....	1-63
Braided Sleeve: S-Glass Precision Small Diameter / Thin Wall: Plain or Heat Treated .....	1-65
Braided Sleeve: E-Glass Precision Small Diameter / Heavy Wall: Heat Treated – w/Binders .....	1-67
Braided Sleeve: E-Glass Precision Premium Grade / Special Thin Wall .006 & .008: Plain and with Binders .....	1-69
Braided Sleeve: E-Glass Precision Small Diameter / Standard Wall: Heat Treated with Acrylic coating .....	1-71
Braided Sleeve – BlackMax Exhaust Pipe Protection .....	1-74

**1200°F / 648°C DeltaGlass™ Fiberglass with Graphite Impregnation**

Braided Sleeve with Graphite Impregnation .....	1-75
---	------

**1382°F / 750°C ExhaustSock™ 1500 Basalt Fiber Knitted Conformable Exhaust Pipe Sleeve**

Braided Basalt Sleeve – Premium Grade .....	1-76
---	------

**1000°F / 537°C Braided Carbon Fiber Sleeve**

Braided Carbon Fiber Sleeve – Premium Grade .....	1-77
---	------

**1500°F / 815°C FlameShield™ 1500 Fiberglass Based with Vermiculite Coating**

Braided Sleeve w/Vermiculite Coating – Premium Grade .....	1-79
Braided Sleeve w/Vermiculite Coating – High Bulk Texturized - Premium Grade .....	1-81

**1500°F / 815°C Specialty Sleeves with Velcro for Weld Splatter Protection**

Specialty Sleeve with Velcro Closure:: FG / WeldShield™ .....	1-82
---	------

**1800°F / 982°F InSilMax™**

InSilMax™ Braided Silica Sleeve .....	1-83
---------------------------------------	------

**1800°F / 982°F InSilMax™ +PL**

InSilMax™ +PL Heavy Wall Braided Sleeve .....	1-84
---	------

**1900°F / 1037°F InSilMax™ XT Silica**

InSilMax™ XT Braided Sleeve .....	1-85
-----------------------------------	------

**2000°F / 1093°C CerMax™ Ceramic Fiber Braided Sleeve**

High Temperature, Heat & Flame Resistant Sleeve .....	1-86
---	------

**2300°F / 1260°C AluMax™ Alumina Braided Sleeve**

High Temperature, Heat & Flame Resistant Sleeve .....	1-87
---	------

**1200°F / 648°C FlameShield™ Spark Plug & Ignition Wire Boot Protection Sleeve**

High Temperature, Heat & Flame Resistant Sleeve .....	1-88
---	------

**1000°F / 537°C DeltaGlass™ Fiberglass with Heat Reflective Coating**

Heat Reflective Aluminized PET Coated Fiberglass Split-Sleeve with adhesive closure .....	1-89
Heat Reflective Aluminized PET Coated Fiberglass Sleeve .....	1-90
Heat Reflective Aluminized PET Coated Fiberglass Sleeve, High Bulk Convuluted .....	1-91
Heat Reflective Aluminized PET Coated Fiberglass Sleeve forming Tape with adhesive strip .....	1-92
Sewn Sleeve with Aluminum Foil Coating .....	1-93
Sewn Sleeve with Aluminum Film Coating .....	1-94
Sewn Sleeve with Aluminum Foil Coating & Velcro Closure .....	1-95
Sewn Sleeve with Aluminized PET Film Coating & Velcro Closure .....	1-96
Heat Reflective Aluminized PET Coated Fiberglass Sleeve with Zipper Closure .....	1-97
Heat Reflective Aluminum Foil Coated Fiberglass Split Sleeve with metal snap closure .....	1-98
Heat Reflective Sewn Fiberglass Sleeve with Stainless Steel Coating & Velcro Closure .....	1-99

**1000°F / 537°C DeltaGlass™ EMI / RFI Shielding Sleeve**

EMI / RFI Shielding Split Sleeve with earthing braid and snap closure .....	1-100
EMI / RFI / EMF Non Magnetic Shielding Split Sleeve with adhesive closure .....	1-101
EMI / RFI Shield Sleeve .....	1-102

**1832°F / 1000°C Tinned Copper Metal Braided Sleeve**

Tinned Copper Metal Braided Sleeve: Tubular .....	1-103
Tinned Copper Metal Braided Sleeve: Flat .....	1-104

**1472°F / 800°C Brass Braided Sleeve**

Brass Metal Braided Sleeve: Tubular .....	1-108
---	-------



**Thermal, EMI/RFI & Abrasion Protection Materials**

Fax Orders: 610-340-9054 Telephone Orders: 610-906-3549 orders@abthermal.com

**2500°F / 1371°C Stainless Steel Metal Braided Sleeve – Hose Size & Standard Size**

Stainless Steel Braided Sleeve – Hose Size / 304SS / 321SS / 316L SS – Heavy Duty .....	1-109
Stainless Steel Braided Sleeve – Standard Size .....	1-110

**1200°F / 648°C Stainless Steel Hollow Knitted Mesh Sleeve**

Stainless Steel Hollow Knitted Mesh Sleeve .....	1-111
--	-------

**1200°F / 648°C Solid Wall Semi-Flexible Stainless Steel Sleeve**

Solid Wall Metal Flexible Sleeve .....	1-112
--	-------

**HOSE / DUCTING**

**Hose / Duct: 1500°F / 815°C FlameShield™ Exhaust Hose**

High Temperature, Heat & Flame Resistant Hose for metal processing ventilation .....	1-113
--	-------

**Hose / Duct: 300°F / 148°C FlameShield™ Exhaust Hose**

High Temperature, Heat & Flame Resistant Hose for welding applications ventilation .....	1-114
--	-------

<b>Wire, Cable, Harness and Hose Overbraid Service .....</b>	<b>1-115</b>
--	--------------

<b>Sleeve Size Reference Chart .....</b>	<b>1-116</b>
--	--------------

## 2. Tape, Tadpole Tape & Lacing Tape

### 320°F / 160°C Kevlar Woven Aramid Tape - Premium Grade

FlameShield Kevlar Woven Aramid Tape - MIL-T-87130 .....2-1

### 392°F / 200°C Fiberglass Fine Weave Tape with Silicone Adhesive

Glass Cloth High Temperature Tape – UL & Mil-i-19166C .....2-2

Glass Cloth High Temperature Tape - Industrial Grade .....2-4

### 500°F / 260°C FlameShield™ Silicone Rubber Coated Fiberglass Tape

Tape & Wrap: *One Side Coated Silicone Rubber Coated Knitted Fiberglass Tape – non adhesive* .....2-5

Heavy Duty Tape & Wrap: *One Side Coated Silicone Rubber Coated Woven Fiberglass Tape – non adhesive* .....2-6

Two-Side Coated Silicone Rubber Fiberglass Tape & Wrap – *non adhesive* .....2-7

Two-Side Coated Silicone Rubber Fiberglass Tape & Wrap - Premium – *non adhesive* .....2-8

### 500°F / 260°C FlameShield™ Silicone Rubber Self Fusing Tapes

MIL Spec Silicone Rubber Self Fusing Tape: *Meets MIL-I-46852 / A-A-59163* .....2-9

MIL-I-46852 Class 1 Type I & Type II .....2-12

AA59163-Class 1 Type I & Type II .....2-15

AA59163-Class 2 Type IM & Type IIM .....2-18

MIL-I-22444 MIL Spec Silicone Rubber Reinforced Limited Stretch Self Fusing Tape .....2-21

MIL Spec Silicone Rubber Reinforced Limited Stretch Self Fusing Tape: SA & SB Type: *Meets MIL-I-22444* .....2-23

Silicone Rubber Self Fusing Tape: *Meets Boeing DMS2186 Type I and DMS2186 Type II* .....2-24

Silicone Rubber Self Fusing Tape: *Meets Lockheed-Martin MMSJ517: Type I & Type II* .....2-25

Silicone Rubber Self Fusing Tape: *Meets Lockheed-Martin Space Systems 5-00857 & 5-00615* .....2-26

Silicone Rubber Self Fusing Tape: *Meets Lockheed-Martin Tactical Systems P5189* .....2-27

Silicone Rubber Self Fusing Tape: *Meets Lockheed-Martin Systems Integration 6084744* .....2-28

Silicone Rubber Self Fusing Tape: *Meets General Dynamics P5384* .....2-29

Silicone Rubber Self Fusing Tape: *Meets Boeing HS5215E103 NSN 5330-01-479-4233* .....2-30

Silicone Rubber Self Fusing Tape: *Meets UL 94V0 & UL 94HB* .....2-31

Silicone Rubber Self Fusing Tape: *Meets Rockwell International ST0130RB0078: Type I & Type II* .....2-32

Silicone Rubber Self Fusing Tape: *Meets GE Power Generation A50A493 & 3003M70* .....2-33

Silicone Rubber Self Fusing Junction Insulation Tape: *Meets GE Transportation A50E112 & EMS2074* .....2-34

Silicone Rubber Self Fusing Tape: *Meets Rohr RMS315* .....2-35

Silicone Rubber Self Fusing Tape: *Meets Garmin 249-0014-00* .....2-36

Silicone Rubber Self Fusing Tape: *Amphenol ITT Canon Backshell Clamp Tape/Bushing* .....2-37

Silicone Rubber Self Fusing Tape: *Meets FAR 25.853 Appendix F Horizontal & Vertical Burn Rate Limits* .....2-36

Silicone Rubber Self Fusing Tape: *Meets MIL-I-46852 / A-A-59163 with NSN Number Assignment* .....2-37

ColeFlex TYT200-1 "No Heat" Silicone Self Fusing Tape .....2-38

MOX 602 / MOX 603 / MOX 604 T Series MIL Spec Silicone Rubber Self Fusing Tape .....2-39

MOX 615 / MOX 620 / MOX 630 / MOX 640 R Series MIL Spec Silicone Rubber Self Fusing Tape .....2-40

Nimikkeistokeskus NCB Finland 10134254 Series MIL Spec Silicone Rubber Electrical Insulation Tape .....2-42

Markel 4529670544 NSN 5970-00-955-9976 Equivalent Silicone Rubber Electrical Insulation Tape .....2-43

66N / 67N / 68N / 69N / 78N / 79N Silicone Rubber Self Fusing Tape .....2-44

RL6000SA / RL6000SB StretchTape™ Equivalent Silicone Rubber Self Fusing Tape .....2-45

ABS5334A01 & ABS5334A02R Silicone Rubber Self Fusing Electrical Insulating Tape .....2-46

Eaton Weatherhead A6900W Equivalent Tape .....2-47

Seal-Tite P29950 / P28566 / P40630 / P36728 Fusion Wrap Equivalent Silicone Elastomer Tape .....2-48

Simrit - Freudenberg NOK Equivalent Tape - Type I & Type II: *Meets MIL-I-46852 / A-A-59163* .....2-49

Simrit - Freudenberg NOK Equivalent Tape - Type I & Type II: *Meets MIL-I-22444 / MIL-I-46852 / A-A-59163* .....2-50

L-3 Communications Tape 40014362: .....2-51

3M Scotch® 70 Equivalent Tape .....2-52

GE and EMD Semi-Cured and Uncured Traction Motor Coil Encapsulating Tape .....2-53

PipeSeal Drain Pipe Leak Sealing Tape – Septic Inlet and Drain Pipe Leak Sealing .....2-54

DuctSeal Stovepipe and Flue Gas Duct Sealing Tape .....2-55

### 550°F / 287°C DeltaGlass™ Gasket Seal Tape with PTFE Coating

Fiberglass Gasket Seal Tape with soft PTFE Coating: Premium Grade .....2-56

Fiberglass Gasket Seal Tape with soft PTFE Coating: Industrial Grade .....2-57

### 550°F / 287°C DeltaGlass™ Tape with PTFE Resin Impregnation & Self Adhesive

Fiberglass Tape with PTFE Resin Impregnation & Self Adhesive; Premium & Industrial .....2-58

### 550°F / 287°C Skived PTFE Tape with Self Adhesive

Skived PTFE Tape with Self Adhesive .....2-61

### 550°F / 287°C MIL-I-23594 / MIL-I-59474 / AA-59474 Skived PTFE Tape with Self Adhesive

Skived PTFE Tape with Self Adhesive .....2-62

<b>550°F / 287°C ePTFE Joint Seal Tape</b>	
Expanded PTFE Joint Seal Tape .....	2-63
<b>550°F / 287°C DeltaGlass™ Tape with PTFE Resin Impregnation, Non Adhesive / FDA</b>	
Fiberglass Tape with PTFE Resin Impregnation, Non Adhesive / FDA; Premium .....	2-64
Fiberglass Tape with PTFE Resin Impregnation, Non Adhesive / FDA; Industrial .....	2-65
<b>550°F / 287°C Tuff-Flex™ Tacky Cloth Rubberized Fiberglass Tape</b>	
Universal Rubberized Fiberglass Gasket Tape (Tacky Cloth): with / without Wire Insert .....	2-66
Luting & Groove Packing - Wire Inserted .....	2-67
<b>1200°F / 648°C DeltaGlass™ Plain Fiberglass Knitted &amp; Woven Tape</b>	
Woven Fiberglass Electrical Apparatus Insulating Tape .....	2-68
Fiberglass Knitted Plain Tape & Bolt Hole / Ladder Tape: Premium Grade .....	2-69
Fiberglass Woven Plain & Bolt-Hole / Ladder Tape – Premium Grade .....	2-70
Fiberglass Woven Plain & Bolt-Hole / Ladder Tape – Premium Grade with PSA Adhesive .....	2-72
Fiberglass Woven Plain & Bolt-Hole / Ladder Tape - Industrial Grade .....	2-73
Fiberglass Woven Plain & Bolt-Hole / Ladder Tape - Heat Treated-Heat Cleaned .....	2-74
Fiberglass Woven Plain & Bolt-Hole / Ladder Tape – Premium Grade / Special Thin .....	2-75
Fiberglass Woven Plain Tape – Color Coded .....	2-76
<b>1350°F / 732°C ProSil™ Silica/Glass Woven Tape</b>	
ProSil™ Silica/Glass blend tape .....	2-77
<b>1350°F / 732°C RockGlass™ Rock Fiber Basalt Woven Tape</b>	
RockGlass™ Basalt Header Wrap & Thermal Insulating Tape .....	2-79
<b>1500°F / 815°C FlameShield™ 1500 - Fiberglass Woven Tape with Vermiculite Coating</b>	
<b>Meets ASTM-E-162, ASTM-E-662 &amp; SMP-800-C Flammability and Toxic Gas Production Limits</b>	
Fiberglass with Vermiculite Coating Tape, Plain & Bolt-Hole / Ladder Tape – Premium Grade .....	2-81
Fiberglass with Vermiculite Coating Tape, Plain & Bolt-Hole / Ladder Tape – Industrial Grade .....	2-83
Fiberglass with Vermiculite Coating Tape, Plain & Bolt-Hole / Ladder Tape – Premium Grade / Special Thin .....	2-85
<b>1100°F / 593°C to 1500°F / 815°C DeltaGlass™ PowerTorque™ Tape</b>	
Automotive Manifold, Header, Turbo & Exhaust Pipe Tape & Wrap .....	2-86
<b>1900°F / 1037°C InSilMax™ Silica Tape</b>	
InSilMax Silica Slit Tape .....	2-87
InSilMax Silica Slit Tape with PSA adhesive .....	2-88
InSilMax Silica Folded & Stitched Tape .....	2-89
InSilMax Silica Woven Tape .....	2-90
<b>2000°F / 1093°C CerMax™ Ceramic Fiber Tape</b>	
CerMax™ Ceramic Fiber Tape .....	2-91
<b>950°F / 510°C to 5400°F / 2982°C GraphTek™ Flexible Graphite Tape</b>	
GraphTek™ Flexible Graphite Tape .....	2-93
<b>1000°F / 537°C DeltaGlass™ Fiberglass Base with Heat Reflective Coating</b>	
Fiberglass with Aluminum Foil Coated Tape .....	2-94
Fiberglass with Stainless Steel Foil Coated Tape .....	2-96
Aluminum Foil Tape with Acrylic Adhesive, MIL-T-23397B Type 2 .....	2-97
Lead Foil Tape with Natural Rubber Adhesive .....	2-98
Gold Look Colored Aluminized PET Film with Acrylic Adhesive .....	2-99
Aluminized PET Film Coated Fiberglass Tape .....	2-100
Weld Backing Tape .....	2-101
InsulSave™ Insulated Pipe Wrap Tape .....	2-102
<b>Pressure Sensitive Adhesive Spray &amp; Tape for Mounting Assistance:</b>	
FlangeStik™ Pressure Sensitive Adhesive Spray for Tape Mounting .....	2-106
Insulating Tape Mounting Tape .....	2-107



## Tadpole Tapes

### 500°F / 260°C Silicone Rubber Based

Stainless Mesh Tadpole with Silicone Rubber Bulb .....2-109

### 550°F / 287°C Aramid High Strength Tadpole

Aramid Tadpole Gasket Tapes .....2-110

### 1200°F / 648°C Fiberglass Based

Fiberglass Precision Tadpole Gasket Tapes .....2-111

Fiberglass Heavy Duty Tadpole: Rope or Wire Mesh Core .....2-112

### 1350°F / 732°C ProSil™ Silica/Glass Blend

High performance ProSil™ Silica/Fiberglass Blended Fabric Tadpole Gasket Tapes .....2-113

High performance ProSilMax™ Silica/Fiberglass Blended Fabric with wire insert Tadpole Gasket Tapes .....2-114

### 1500°F / 815°C Fiberglass Based w/ Vermiculite Coating FlameShield™ 1500

*Meets ASTM-E-162, ASTM-E-662 & SMP-800-C Flammability and Toxic Gas Production Limits*

Fiberglass with Vermiculite Coating Tadpole: Heavy Duty with Rope or Wire Mesh Core .....2-115

### 1800°F / 982°F InSilMax™ Silica

Silica Heavy Duty Tadpole with Rope or Wire Mesh Core .....2-116

### 1900°F / 1037°F InSilMax™ XT Silica

Silica Heavy Duty Tadpole with Rope or Wire Mesh Core .....2-117

### 2000°F / 1093°F CerMax™ Ceramic

Silica Heavy Duty Tadpole with Rope or Wire Mesh Core .....2-118

## Tadpoles with Specialized Coatings

### 550°F / 287°C PTFE Coated Fiberglass

Fiberglass with PTFE Coating Heavy Duty Tadpole – Rope or Wire Mesh Core .....2-120

### 550°F / 287°C Tuff-Flex™ Tacky Cloth Rubberized Fiberglass

Rubberized Fiberglass Heavy Duty Tadpole - Rope Core with / without Wire Insert .....2-121

### 550°F / 287°C expanded PTFE

Expanded PTFE Tadpole Tapes 550°F / 287°C .....2-122

### TTWearGuard™ Tadpole Tape Cover Mesh

Stainless Steel Mesh Cover for Tadpole Tape Enhanced Abrasion Resistance .....2-123

## Lacing Tapes

### Wiring bundling and organization

Nylon Lacing Tape A-A-52080 Type I / MIL-T-43435 .....2-126

Polyester Dacron Lacing Tape A-A-52081 Type II / MIL-T-43435 .....2-127

PTFE Fluorocarbon Teflon Lacing Tape A-A-52082 Type III / MIL-T-43435 .....2-128

Fiberglass (E-grade) Lacing Tape A-A-52083 Type IV / MIL-T-43435 .....2-129

Nomex Meta Aramid Lacing Tape A-A-52084 Type V / MIL-T-43435 .....2-130

## 3. Rope and Packing

### 320°F / 160°C Kevlar® 12-Strand Single Braid Rope

FlameShield™ Kevlar High Temperature Heat Resistant High Strength & Cut Resistant .....3-1

### 500°F / 260°C Solid Silicone Rubber Cord / Rope

FlameShield™ Silicone Rubber Cord / Rope .....3-2

### 392°F / 200°C Silicone Sponge Cord

FlameShield™ Silicone Rubber Sponge Cord .....3-3

### 500°F / 260°C Silicone Rubber Coated Fiberglass

FlameShield™ Fiberglass Rope with Silicone Rubber Coating: *Gasket Rope for Liquid / Gas / Steam* .....3-4

### 550°F / 287°C Acrylic Braid with PTFE Impregnation

Acrylic Fiber With PTFE Impregnation Square Braid Rope .....3-6

**550°F / 287°C Pure PTFE Square Braid**

Pure PTFE Square Braid Rope .....3-7

**550°F / 287°C DeltaGlass™ Fiberglass with soft PTFE Coating Gasket Rope**

Fiberglass Knitted Rope with soft PTFE Coating: Soft Rope .....3-8

Fiberglass Knitted Rope with soft PTFE Coating: Dense Rope .....3-9

Fiberglass Twisted Rope with soft PTFE Coating .....3-10

Fiberglass Square Braided Rope with soft PTFE Coating .....3-11

**550°F / 287°C PT-Graf™ PTFE Square rope with Graphite Coating**

Square Braided Graphite Coated PTFE Rope .....3-12

**1200°F / 648°C DeltaGlass™ Fiberglass**

Fiberglass Knitted Rope - Premium Grade – Soft (High Compressibility) .....3-13

Fiberglass Knitted Rope - Premium Grade – Dense (Low Compressibility) .....3-15

Fiberglass Knitted Rope - Industrial Grade – Soft .....3-17

Fiberglass Knitted Rope - Industrial Grade – Dense .....3-18

Fiberglass Twisted Rope - Premium Grade .....3-19

Fiberglass Braided Square Rope (Square Dry Packing) - Premium Grade .....3-20

Kevlar Overbraided Fiberglass Rope .....3-21

Fiberglass Compression Gasket Rope – Clip Mounting – Hollow Core .....3-22

Fiberglass Knitted Texturized Rope with Stainless Mesh Core .....3-24

Fiberglass Braided Filament Rope with Stainless Mesh Core (Clean Room & Paint Shop Gaskets) .....3-25

Fiberglass Rope with Wire Mesh Jacket for Kiln Door Seals, Custom .....3-26

Fiberglass Rope with Wire Mesh Jacket for Kiln Door Seals, 1.5" x 2.0" .....3-27

TurbineSeal Jacketed Turbine Exhaust Gasket Seal .....3-28

Fiberglass Rope with Graphite Coating / Impregnation: Round Soft .....3-29

Fiberglass Rope with Graphite Coating / Impregnation: Round Dense .....3-30

Fiberglass Braided Square Rope with Graphite Coating / Impregnation .....3-31

**900°F / 482°C GraphPack™ Graphite Yarn**

Pure Graphite Square Rope - Packing .....3-32

**1500°F / 815°C FlameShield™ 1500 Fiberglass Based with Vermiculite Coating**

Fiberglass with Vermiculite Coating Rope – Soft .....3-34

Fiberglass with Vermiculite Coating Rope – Dense .....3-35

Fiberglass with Vermiculite Coating Rope – Twisted .....3-36

Fiberglass with Vermiculite Coating Braided Square Rope .....3-37

**1800°F / 982°F InSilMax™ Silica / 2000°F / 1093°F InSilMax™ XT Silica**

Silica Knitted Cord / Rope - Small Size .....3-38

Silica Knitted Rope .....3-39

Silica Twisted Rope .....3-40

Silica Square Braided Rope .....3-41

**2300°F / 1260°C CerMax™ Ceramic Fiber Rope**

Ceramic Fiber Rope: Braided - Premium & Industrial Grade .....3-42

Ceramic Fiber Rope: Twisted - Premium & Industrial Grade .....3-43

Ceramic Fiber Rope: Square Braided - Premium & Industrial Grade .....3-44

Ceramic Fiber Rope: Square Braided - With Wire Insert .....3-45

**2190°F / 1200°C Stainless Steel & Inconel Mesh Rope**

304 Stainless Steel Mesh Rope .....3-47

Inconel Mesh Rope .....3-47

**4. Fabric / Cloth / Fireblanket / Sheet**

**500°F / 260°C FlameShield™ Silicone Rubber Sheeting**

**Hot process protection pad**

Silicone Rubber High Temperature & Heat Resistant Square Sheet Pad for Hot Process work .....4-1

Silicone Rubber Sheet Roll .....4-2

**500°F / 260°C FlameShield™ Fiberglass Reinforced Silicone Rubber Sheet**

**AMS3320 & AMS3315**

Fiberglass Reinforced Silicone Rubber Sheet – gasket and baffle material .....4-3

<b>500°F / 260°C FlameShield™ Fiberglass Reinforced Thermal Transfer Insulator Fabric</b>	
Fiberglass Reinforced Silicone Rubber High Thermal Transfer .....	4-4
<b>500°F / 260°C FlameShield™ Fiberglass Reinforced Silicone Rubber Coated Fabric</b>	
Fiberglass Reinforced Silicone Rubber Coated Fabric - Ultra Premium Grade .....	4-6
<b>500°F / 260°C FlameShield™ Fiberglass Reinforced Silicone Rubber Coated Fabric - FDA</b>	
Fiberglass Reinforced Silicone Rubber Coated Fabric - FDA Compliant .....	4-7
<b>500°F / 260°C FlameShield™ Silicone Rubber Coated Fiberglass</b>	
<b>Molten Metal Splash / Weld Spatter / Contamination / UV &amp; Spark Protection</b>	
Fire Blanket / Welding Blanket / Curtain-Shield Fabric: Medium & Heavy Duty 1 - Side Coated .....	4-8
Fire Blanket / Welding Blanket / Curtain-Shield Fabric: Light Duty - 2 Side Coated .....	4-10
Fire Blanket / Welding Blanket / Curtain-Shield Fabric: Medium - 2 Side Coated .....	4-11
Fire Blanket / Welding Blanket / Curtain-Shield Fabric: Heavy Duty - 2 Side Coated .....	4-11
<b>500°F / 260°C Dual-Coat™ Aluminum / Silicone Rubber Coated Fiberglass</b>	
Heat Reflecting on One Side – Silicone Rubber Vapor Barrier on Opposite Side .....	4-12
<b>550°F / 287°C Tuff-Flex™ Tacky Cloth Rubberized Fiberglass</b>	
Gasket Fabric: with/without Wire Insert .....	4-13
<b>550°F / 287°C DeltaGlass™ with soft PTFE Coating Gasket Sealing Fabric</b>	
Fiberglass Fabric with PTFE Coating .....	4-15
<b>550°F / 287°C DeltaGlass™ with PTFE Resin Impregnation &amp; Self Adhesive</b>	
Fiberglass Fabric with PTFE Resin Impregnation and Self Adhesive, Premium .....	4-16
Fiberglass Fabric with PTFE Resin Impregnation and Self Adhesive, Industrial .....	4-17
Fiberglass Fabric with PTFE Resin Impregnation and Self Adhesive, FDA Compliant .....	4-18
Fiberglass Fabric with PTFE Resin Impregnation and Self Adhesive, Anti-Static .....	4-20
<b>1200°F / 648°C DeltaGlass™ Fiberglass Based</b>	
Fiberglass Cloth Fabric Roll – Premium Grade .....	4-22
Heat Treated Fiberglass Cloth Fabric Roll – Premium Grade .....	4-23
Weld Spatter Shield Fiberglass Cloth Fabric Roll – Premium Grade .....	4-24
HHP-31 Asbestos Replacement Fabric: <i>Fiberglass Fabric with Stainless Steel Wire Insert</i> .....	4-25
Fiberglass Cloth Fabric with Stainless Steel and Inconel Wire Insert .....	4-26
Fiberglass Cloth Fabric with Stainless Steel Wire Insert - FAA Approval .....	4-27
<b>750°F / 399°C AraMax™ Poly-Layered Aluminum Film Coated Aramid Fabric</b>	
Aluminum Film Coated Aramid .....	4-28
<b>1000°F / 537°C MIL Spec and Standard Heat Reflective Aluminum Foil Coated</b>	
Aluminum Foil Coated Fiberglass .....	4-29
<b>1000°F / 537°C AluMax™ Poly-Layered Aluminum Film Coated Fiberglass Fabric</b>	
Aluminized PET Film Coated Fiberglass .....	4-30
<b>1000°F / 537°C AluMax™ Poly-Layered Aluminum Film Coated Protective Clothing Fabric</b>	
Aluminized PET Film Coated .....	4-31
<b>1000°F / 537°C Heat Reflecting Fiberglass with Aluminum Flake Impregnation</b>	
Aluminum Flake Impregnation Heat Reflecting Fabric .....	4-32
<b>1000°F / 537°C DeltaGlass™ Stainless Steel Foil Coated Fiberglass Fabric</b>	
Stainless Steel Foil Coated Fiberglass .....	4-33
<b>1200°F / 648°C Basalt Rock Fiber</b>	
Basalt Rock Fibre Fabric .....	4-34
<b>1300°F / 704°C HTC Coated Wire Reinforced Fiberglass</b>	
HTC Coated Fiberglass with Inconel Wire Reinforcement .....	4-35
<b>1400°F / 760°C DeltaGlass™ S-Glass</b>	
S-Glass Fiberglass Fabric .....	4-36
<b>1500°F / 815°C FlameShield™ 1500 Fiberglass Based with Vermiculite Coating</b>	
Fiberglass with Vermiculite Coating Blanket / Cloth / Fabric Roll .....	4-37

<b>1800°F / 982°F InSilMax™ Silica with one side silicone rubber coating</b>	
Silica Cloth Fabric .....	4-39
<b>1800°F / 982°F InSilMax™ Silica</b>	
Silica Cloth Fabric .....	4-40
<b>2000°F / 1093°F InSilMax™ XT Silica</b>	
Silica Cloth Fabric .....	4-41
<b>2300°F / 1260°F AluMax™ Alumina</b>	
Alumina Fabric .....	4-42
<b>2300°F / 1260°C</b>	
Ceramic Paper: Premium Grade .....	4-43
<b>2300°F / 1260°C CerMax Ceramic Fiber</b>	
Ceramic Cloth Fabric: Premium Grade .....	4-44
<b>2300°F / 1260°C CerMax™ Ceramic Fiber</b>	
Ceramic Cloth Fabric: Industrial Grade .....	4-46
<b>950°F / 510°C to 5400°F / 2982°C GraphTek™ Graphite Sheet Roll &amp; Laminate</b>	
Graphite Sheet Roll: Premium Grade .....	4-48
<b>1200°F / 648°C Knitted Stainless Steel / Inconel Mesh Fabric</b>	
304 Stainless Steel Knitted Mesh Fabric, .011" wire .....	4-49
Inconel Knitted Mesh Fabric, .008" wire .....	4-49

**5. Insulation Felt / Batt**

<b>500°F / 260°C</b>	
DeltaMax™ Silicone Sponge Foam Insulation .....	5-1
<b>500°F / 260°C</b>	
PyroTection™ Nomex® Needled Insulation Felt .....	5-2
<b>500°F / 260°C</b>	
PyroTection™ Kevlar® Aramid Needled Insulation Felt .....	5-3
<b>1200°F / 648°C</b>	
DeltaMax™ Needled Insulation – Premium Grade .....	5-4
<b>1800°F / 982°F</b>	
InSilMax™ Silica Needled Insulation: Premium Grade .....	5-5
<b>2000°F / 1093°F</b>	
InSilMax™ XT Silica Needled Insulation: Premium Grade .....	5-6
<b>1800°F / 982°F</b>	
InSilSafe™ Vitreous Silicate (Ceramic Free) Needled Insulation: Premium Grade .....	5-7
<b>1800°F / 982°F</b>	
InSilPro™ Silica Non-Woven Insulation .....	5-8
<b>2300°F / 1260°C</b>	
CerMax™ Ceramic Insulation: Premium Grade .....	5-9
<b>1200°F / 1260°C</b>	
CerMax™ Ceramic Insulation: Premium Grade .....	5-9

**6. Tuff-Wrap™ and Scuff-Sleeve™ Abrasion & Wear Resistant Sleeve & Spiral Wrap  
Hose, Cable and Wire Protection**

<b>Sleeve: Scuff-Sleeve™ Abrasion Protection Nylon and Nylon with Velcro</b>	
Nylon Abrasion Resistant Protection Braided Sleeve - .020 Monofilament .....	6-1
Nylon Abrasion Resistant Protection Braided Sleeve - .050 Monofilament .....	6-2
Nylon Abrasion Resistant Protection Sleeve, woven .....	6-3
Nylon Abrasion Protection Sleeve A-A-59301 & MIL-C-572 .....	6-4
Nylon Abrasion Protection Sleeve A-A-59301 & MIL-C-572: Heavy Wall .....	6-5
Heavy Wall Hi-Flex, .045 Wall .....	6-6
Heavy Wall Pro Hi-Flex, .080 Wall .....	6-7
Nylon Abrasion Protection Sleeve with Hook Loop closure .....	6-8
Nylon HD Abrasion Protection Sleeve with Hook Loop closure .....	6-9

Nylon XHD Abrasion Protection Sleeve with Hook Loop closure .....	6-10
Nylon PVC Coating Abrasion Protection Sleeve with Hook Loop closure .....	6-11
Nylon with Neoprene Coating Abrasion Protection Sleeve with Hook Loop closure .....	6-12
Fiberglass with Neoprene Coating Abrasion Protection Sleeve with Hook Loop closure .....	6-13
Nylon HD Abrasion Protection Sleeve with Hook Loop closure – Custom Size .....	6-14
Nylon with Kevlar Lining Hydraulic Blowout & Abrasion Protection Sleeve .....	6-15
SPF Spray Foam Hose Protector Sleeve with Hook Loop closure .....	6-16
PET Flexible Wrappable Split Braid Sleeve .....	6-17
Polyester Flexible Wrappable Split Woven Sleeve .....	6-18
Polyester Flexible Wrappable Split Woven Sleeve with Hook One Side .....	6-19
Braided PET 150% Expandable Sleeve .....	6-20
Cinch and Hanging Straps .....	6-21

**Spiral Wrap: Tuff-Wrap™ Wire & Cable Abrasion Protection**

Hard Shell Hose and Cable Protection Spiral Wrap .....	6-22
HDPE Spiral Wrap Hard Shell Hose and Cable Protection .....	6-24
SafeEdge™ Mine Approved Hard Shell Hose and Cable Protection MSHA IC-271 .....	6-25
TellTale™ Spiral Wrap with Wear Indicating Layer for Hose & Cable Protection .....	6-26
SafetyWrap™ Spiral Wrap for Hose & Cable Protection .....	6-27

**7. Custom Fabrications: ThermalShield™ Products**

**Custom Manufactured Products and Supplies**

Welding Blankets / Curtains .....	7-1
InSilMax Cloth Plumber / Welder Pads .....	7-4
InSilMax Cloth Kneeling Pads .....	7-5
Annealing Pads for Glass and Metal Processing .....	7-6
High Temperature Removable Blanket and Insulation for Engine Exhaust System Components .....	7-7
Standard Blanket Sets: Engines, Gensets, SCRs, Vehicles .....	7-11
Engine & Exhaust System Standard Templates .....	7-29
ExhaustGuard™ Fire Protection Removable Blanket and Shield Insulation Systems for Mine Equipment .....	7-34
High Temperature Removable Insulation Covers for Industrial / Marine Valves and Piping .....	7-35
Blow-Out / Spray Protection Shields for Valves & Pipe Flanges .....	7-36
Steel Mill and Metal Processing Plant Custom Fabrications: Festoon Power Track and Lift Cylinder Protection .....	7-37
High Temperature Removable Insulation Covers for Gas Cylinders .....	7-38
Heated Removable Insulation Covers & Heating Pads for Tote Tanks / Industrial Bulk Containers .....	7-39
55 & 30 Gallon Drum Insulated Covers & Covers with Heaters .....	7-40
Eco-Blanket™ Insulated Equipment Covers .....	7-43
Robotic Covers – Thermal / Weld Splatter Protective – Food Handling FDA Approved .....	7-44
Steam Trap Jackets: Inverted Bucket / F&T Styles .....	7-45
High Temperature Conveyor Belts – PTFE or Silicone Coated Fabric or Porous .....	7-24
High Temperature Heat Resistant Sewing Threads .....	7-47
Filament Kevlar .....	7-48
Spun Kevlar .....	7-48
Filament & Spun Nomex .....	7-49
Fiberglass, Metal, Quartz .....	7-50
Hook & Loop Closure Fasteners .....	7-51
Zippers .....	7-55
Scissors, Shears and Cutters .....	7-56
Snap Hardware for Fabric Cover Shield Manufacturing .....	7-57
DuctSeal Fire Rated Duct Access Doors and Sealing Systems .....	7-58

**8. Ceramic Materials**

**Fasteners, Crucibles, Dense Machinable Rod, Plate, Bar**

Fasteners: Bolts, Nuts, Washers .....	8-1
Machinable Glass-Ceramic Plate & Rod, 750°F / 400°C .....	8-5
Machinable Glass-Ceramic Plate & Rod, 1100°F / 593°C .....	8-6
CerMax High Temperature Round Flat Bottom Crucibles .....	8-7



## 9. Silicone Rubber Products – High Temperature

### *Cured Silicone Rubber Products - Uncured Silicone Rubber Adhesives, Dip, Paint, Ink*

Silicone Rubber Tubing, Premium, Oxide-Red Color .....	9-1
Silicone Rubber Tubing, Premium, Natural / Clear .....	9-4
Silicone Rubber Tubing, Premium, Food / Pharmaceutical / Medical Grade .....	9-5
Silicone Rubber STAR .....	9-7
Silicone Rubber Plugs; Tapered, Tapered Hollow, Straight .....	9-8
Silicone Rubber Adhesive, Sealant, End-Seal-Dip, Paint & Ink .....	9-15
Silicone Rubber Adhesive, Sealant – NSF / FDA / USDA Approved. MIL-A-46106A .....	9-16
Semi-Cured Silicone Rubber Bulk Compound .....	9-17
Silicone Rubber Extruded Profile Gasket & Seal Shapes .....	9-18
Silicone Rubber Electrical Strip Heaters: 5 watt per inch, 120 & 240 VAC, CSA-UL Approved .....	9-19
Polyimide & Silicone Rubber Flexible Strip Heaters .....	9-20
Silicone Rubber Drum & Pail Heaters .....	9-21
Silicone Rubber Heavy Duty Drum & Pail Heaters – CSA Approved .....	9-22
Silicone Rubber Drum Heaters – Hazardous Area Approved – T3 & T4A .....	9-23
Stranded Tinned Copper Wire – with High Temperature High Flexibility Silicone Rubber Extruded Jacket .....	9-24

## 10. Fire Retardants – Fire Stops – Fire Blocks – Fire Rated Wire Cable Pipe Transits

### *Fire Retardants & Fire / Smoke Propagation Inhibitors*

FlameShield™ Fire Retardant Fabric Spray Mix .....	10-1
FlameShield™ Fire Rated Expanding Foam FireStop .....	10-2
FlameShield™ Fire Rated Acrylic Caulk FireStops .....	10-3
FlameShield™ Fire Rated Mortar FireStop .....	10-4
FlameShield™ Fire Rated Retrofit Split-Sleeve Firestop for Wire Cable Passthrough Transit .....	10-5

## 11. High Temperature Sealants / Adhesives

### *Silicone and Ceramic High Strength Adhesives and Sealants*

#### **SILICONE**

Silicone High Temperature Sealants and Adhesives .....	11-1
Silica High Temperature Sealants / Adhesives .....	11-1

#### **CERAMIC**

Ceramic High Temperature High Strength Adhesives and Sealants .....	11-2
Ceramic Metallic Adhesive Paste .....	11-6
High Temperature Corrosion Protection Coatings – .....	11-8
Urethane / Epoxy – .....	11-8
Inorganic Ceramic with fillers .....	11-10
Silicone Based .....	11-11
Silicone-Polyester Based .....	11-13
Silicone Ceramic Adhesive & Potting Compound .....	11-15
High Performance Epoxies .....	
Ultra High Temperature .....	
High Temperature – Special Purpose .....	
High Temperature Potting .....	
High Temperature – Maintenance & Repair .....	
Ultra High Bond Strength .....	
Ceramic Metallic Adhesive Paste .....	11-6

## 12. Metal Foils

Stainless Steel; 304 / 309 / 321 .....	12-1
--	------



**Thermal, EMI/RFI & Abrasion Protection Materials**

Fax Orders: 610-340-9054 Telephone Orders: 610-906-3549 orders@abthermal.com

---

**Cross-Reference Guides**

Industrial Firesleeve ..... X-1  
Aero Grade Firesleeve ..... X-2

**Terms & Conditions – Account Application**

Terms & Conditions ..... F-1  
Account Application ..... F-2

## Technical Notes

### General

**Molten Metal & Weld Splatter Protection.** Silicone rubber coated materials resist molten metal splash and heavy weld splatter very well, as the molten metal does not stick to the silicone. The silicone rubber also has a high thermal dispersion index, transferring the heat at the contact area very rapidly into the surrounding area – minimizing burn-through. For applications involving only weld splatter, curtains, shields and blankets fabricated from silica materials such as cloth, tapes and ropes provide superior protection to burn-through. Plain Fiberglass materials should not be used for weld splatter burn-through protection, although vermiculite coated fiberglass with additional latex or neoprene coating provides moderate protection for light to medium weld splatter.

**Premium vs. Industrial.** Premium and Industrial products provide the same dimensional values in terms of width, inside diameter, thickness or wall thickness; however, Premium products are fabricated from a higher bulk yarn and with a denser weave. Premium products will weigh more and are stiffer than the Industrial version as a result. Premium can be considered a Heavy Duty version of the Industrial item. Premium tapes coated with Vermiculite will retain their pre-coat thickness better than Industrial versions, as the pinch rollers in the coating and drying process can more easily squeeze the Industrial version tapes.

**Silica vs. Ceramic Fiber.** With almost the same temperature range, Ceramic Fiber offers a harder/stiffer material than Silica in the same form. Ceramic based materials are typically composed of approximately 50% SiO<sub>2</sub> and 50% Al<sub>2</sub>O<sub>3</sub> fibers while Silica based materials are almost 100% SiO<sub>2</sub> fibers. Ceramic based materials have a slightly higher continuous use and slightly higher excursion temperature range. Silica based materials provide burn-through protection from molten metal and weld splatter.

**Silica vs. Silica XT.** Standard silica products are made by starting with a fiberglass base material and then leeching the product to result in a mostly silica composition. Silica XT products are made from amorphous silica yarn, resulting in a stronger product with an enhanced temperature rating and less shrinkage.

**Temperature & Application Ratings.** The temperature ratings listed for these products is the maximum continuous “heat soaked” exposure. The ratings are deliberately conservative so that there will be a buffer to allow for short duration over-temperature conditions without detrimental effect or failure of the material.

For most materials, short duration exposure to considerable higher temperatures is possible. Short duration can be several minutes to an hour, and depends on the particular circumstances and installation. One of the important considerations is “heat soak” – materials with thermal inertia will withstand short-term extended temperature exposure without becoming heat soaked.

Many of our materials meet or can provide compliance to the following: U.S. Coast Guard 164.009, CAN/ULC S102-M, UL 723, ANSI/FM 4950, MIL-I-24244, ASTM E-84, ASTM C 795, ASTM E-136, NFPA 701-1999, NFPA-96, NFPA 255, Mercury Free, ROHS compliant.

**Heat Cleaning / Heat Treating.** Heat Cleaning removes organic content from the fibers (burns them off). Heat Treating is a higher temperature process than Heat Cleaning, which changes the actual crystal structure of the fiber. It improves chemical resistance, anneals some of the stress inside the fiber, and improves the stiffness of the fiber.

**Knitted / Woven.** Knitted products, especially tapes, are more flexible and conformable than the equivalent size in a woven version.

**Heat Reflecting Fiberglass with Aluminum Foil / Aluminum Coated Mylar.** Aluminum foil coated fiberglass can withstand higher temperature exposure than Mylar-aluminum coated fiberglass, but the aluminum foil is subject to mechanical and abrasion breakdown with handling, flexing and vibration. It is well suited for applications such as curtains, equipment covers and exhaust system blankets. The aluminum is calendared onto the fiberglass base fabric along with an adhesive. Aluminum foil coated fiberglass can be used to temperatures up to 1000°F / 537°C, however the adhesive will smoke-off above 475°F.

Mylar is a trade name for polyester. On Fiberglass coated with Mylar-aluminum, the Mylar coating will melt and vaporize at a lower temperature than aluminum foil, but it performs better for applications such as bellows, flexible hose and cable covers, moving aperture shields, festoon covers, etc. where there is repetitive movement or flexing or abrasion. Mylar-aluminum coated fiberglass is typically suited to temperatures up to 440°F / 226°C.

## **Materials**

**PTFE Products.** Polytetrafluoroethylene (PTFE) is a fluorocarbon-based polymer material (Teflon® is a branded version of PTFE from DuPont). It is hydrophobic (hates water), biologically inert, non-biodegradable and also has very low friction characteristics. The chemical inertness of PTFE is related to the strength of the fluorine-carbon bond and this is why nothing sticks to PTFE. When stretched, PTFE forms a strong porous material called expanded PTFE (ePTFE) which makes excellent mechanical sealing materials. PTFE offers an excellent temperature range of -200°C to +300°C and is suitable for both cryogenic and high temperature application.

**E-glass and S-glass.** Two types of fiberglass most commonly used are S-glass and E-glass. E-glass has good insulation properties and it will maintain its properties up to 1000°F (815°C) continuous use and for non tensile loaded applications up to 1200°F (648°C). S-glass has a high tensile strength and is stiffer than E-glass, and useable to 1200°F (648°C) continuous and up to 1400° (760°C) for non-tensile loaded applications.

**TecPac™.** TecPac is a compressed sheet, available in 1/64", 1/32", 1/16", 3/32" and 1/8" thick sheets, 60" x 60" square. It is a non-asbestos compressed sheet which has similar properties as asbestos in low temperature applications, and can be used for similar applications. It has anti-stick properties and can be used against gases, water, steam, organic acids, alkalis, aromatic and aliphatic hydrocarbons, oils, greases and refrigerants. Available cut to shape as a filler for slit and machined gaskets.

**TecGraph™.** TecGraph graphite laminate sheet is used for high temperature applications and offers excellent chemical resistance. Available in 1/64", 1/32", 1/16" and 1/8" thick sheets, 39.4" x 39.4" square. Purity is >98%, Ash content is <.5%, Temperature rating of 2500°C.

**TecBlue™.** TecBlue is a blend of polymers and reinforcing materials which provides high compressibility, conformability, heat and chemical resistance. Used in sealing glass-lined equipment in food and chemical processing. Not to be used as a primary gasket material alone – must only be used as a filler. Available in 1/16" and 1/8" thick sheet, 68" x 71" square. Available cut to shape as a filler for slit and machined gaskets.

**EPDM.** Ethylene Propylene. **EPDM rubber (ethylene propylene diene M-class rubber)** is an elastomer which is characterized by wide range of applications. The E refers to Ethylene, P to Propylene, D to diene and M refers to its classification in ASTM standard D-1418. The "M" class includes rubbers having a saturated chain of the polymethylene type. EPDM exhibits satisfactory compatibility with fireproof hydraulic fluids, ketones, hot and cold water, and alkalis, and unsatisfactory compatibility with most oils, gasoline, kerosene, aromatic and aliphatic hydrocarbons, halogenated solvents, and concentrated acids. The main properties of EPDM are its outstanding heat, ozone and weather resistance. The resistance to polar substances and steam are also good. It has excellent electrical properties. It has the ability to retain light colour.

**VITON.** Fluoroelastomer. **Viton** is a brand of synthetic rubber and fluoropolymer elastomer commonly used in O-rings and other moulded or extruded goods. The name is a registered trademark of DuPont Performance Elastomers L.L.C. The fluorine content of the most common Viton grades varies between 66 and 70%.

**Tuff-Flex™ Tacky Cloth.** This fiberglass material is coated with uncured white rubber and must be cured in-situ. This material must be heated to a minimum of 300°F within 60 minutes, then it must sit at 300°F or higher for 90 minutes for the rubber to fully cure. Do not over-torque the material during this curing time or the rubber will be squeezed off of the base material. If the material is not fully cured, the rubber will drip from the material causing voids. After curing the material can be exposed to a lower operational temperature..

## **AB Technology Group**

116 Albert Street – Suite 300, Ottawa, ON K1P 5G3

**Conversions:**

**Length:** 1 Metre = 3.28 Feet 1 Metre = 1.09 Yards 1 inch = 25.4 mm 1 mm = 0.039 inches  
 1 foot = 0.3048 meters 0.001 inch = 0.025 mm  
**Temperature:** °C = (°F-32) x 5/9 °F = (°C x 9/5) + 32  
**Time:** Seconds (Canadian) = (US) / 0.6 Seconds (US) = Seconds (Canadian) x 1.666

**NEMA Grades:**

For sleeves that have UL / CSA approval rating, the following NEMA grades are assigned:

NEMA Grades	
Grade	Voltage Rating
A-1	7000* volt average, 5000 volt minimum individual
B-1	4000* volt average, 2500 volt minimum individual
C-1	2500* volt average, 1500 volt minimum individual
C-2	1500* volt average, 800 volt minimum individual
C-3	No dielectric guarantee

Coated sleeving is categorized by the type of coating, base fabric material, dielectric breakdown voltage, temperature index, and inside diameter as follows:

**Type 2**

A flexible treated sleeving made from inorganic-base yarns such as fibrous glass and impregnated or coated with an insulating material which can be shown by applicable experience or accepted test to have at temperature index of 130 (continuous use at 130°C).

**Type 3**

A flexible treated sleeving made from inorganic-base yarns such as fibrous glass and impregnated or coated with an insulating material, such as polyvinyl chloride, which can be shown by applicable experience or accepted test to have a temperature index of 105 (continuous use at 105°C).

**Type 4**

A flexible treated sleeving made from inorganic-base yarns such as fibrous glass and impregnated or coated with an insulating material, such as silicone resin or polytetrafluoroethylene, which can be shown by applicable experience or accepted test to have a temperature index of 200 (continuous use at 200°C).

**Type 5**

A flexible treated sleeving made from inorganic-base yarns such as fibrous glass and impregnated or coated with an insulating material, such as silicone elastomer, which can be shown by experience or accepted test to have a temperature index of 200 (continuous use at 200°C).

**Type 6**

A flexible treated sleeving made from inorganic-base yarns such as fibrous glass and impregnated or coated with an insulating material, such as epoxies, polyesters, or acrylics, which can be shown by experience or accepted test to have a temperature index of 155 (continuous use at 155°C).

**Sleeving Splices**

Most sleeving is produced to NEMA TF 1 1993, which allows for the following maximum number of splices; 50 foot spool, 2 splices; 100 foot, 3 splices; 150 foot, 3 splices; 250 foot, 4 splices; 500 foot, 7 splices; 1000 foot, 10 splices. Please enquire if you require splice free lengths.

**TradeMarks**

The following are trademarks of AB Technology Group:

FlameShield™, DeltaGlass™, Thermal Protection Solutions™, Keeping Our World Cooler™, TecPac™, TecGraph™, GraphTek™, TecBlue™, SnapSleeve™, ZipSleeve™, Scuff-Sleeve™, Tuff-Flex™, Tuff-Wrap™, InSilMax™, InSulMax™, InsulDynamic™, EasyInstall™, FestoonShield™, ThermalShield™, WeaveHold™, SleeveSeal™, HoseSaver™, CableSaver™, ThermaSleeve™, ThermaTape™, ThermaRope™, ThermaTube™, CerMax™, BlackMax™, PowerTorque™, SilverGuard™, GoldGuard™, InfraShield™, ReflecSleeve™, FireFlex™, SplashGuard™ TTWearGuard™,

Other trademarks are property of their respective owners.



## Selecting Materials

**Color Coded Pictures to Help You Choose The Correct Product for Your Application. Need Help? Expert Advice By Phone or E-mail.**

Technical Assistance: (610) 906-3549 or info@abthermal.com

				
<b>500°F</b> <b>260°C</b>	<b>1000°F</b> <b>537°C</b>	<b>1500°F</b> <b>537°C</b>	<b>2000°F</b> <b>1093°C</b>	<b>2300°F</b> <b>1260°C</b>
 <b>Photo Boarder Color Shows Continuous Rating with higher short exposure</b>				

### Selecting Materials

Selecting materials and designing a protection system can be assisted by understanding the kind of heat in the situation.

**Ambient Heat.** This is the surrounding atmospheric temperature in the area, situation or environment. For example, in an office it might be 70°F, in a firewalk it might be 2000°F.

**Conductive Heat.** This is the heat from direct contact with an object: picking up a hot tray from an industrial oven or kiln at 500°F or the surface of a furnace wall at 1000°F.

**Radiant Heat.** Objects like the Sun, or fire, or molten metal streams, glowing slabs or billets of metal radiate heat waves, which can travel through space or air or objects, and is absorbed by people or other objects. A great example is that it feels cooler standing in shade on a hot day as the shade blocks the radiant heat waves from the sun.

**Molten Metal Splash or Weld Splatter.** Materials with high temperature silicone rubber coating provide excellent protection from molten metal splash and weld splatter as the splash/splatter does not stick to the silicone. As well, the silicone has a high thermal dispersion, quickly dissipating the heat and preventing burn-through. The heavier or larger the splash/splatter then the heavier grade of silicone coated material should be selected.

**Products & Applications:** Our High Temperature Protection Materials have wide ranging application in industry, aviation, Marine and military markets. They are most commonly used in steel making, metal processing & refining, smelting, foundries, robotic welding, heat treating, steam plants, power plants (fossil and nuclear), engine and vehicle manufacturing, tire and glass manufacturing, brick & tile manufacturing, petrochemical refining, etc. In fact, any industry with a hot process, boiler, oven or kiln can use our products. It is the customers' responsibility to ensure the suitability of products to applications.

## How To Order

**Pricing:** Prices shown are \$USD and may be subject to change without notice. Orders in other currencies may be accepted by quotation.

**Accounts:** Please complete our Account Application Form (available at the rear of this catalogue or on web-site) and return the form along with your standard credit reference sheet. Account application processing can take 2 to 3 business days.

**New Customers:** New customers may order immediately by paying via credit card, PayPal, bank wire transfer. We accept Visa, MasterCard and American Express payments by phone, fax and e-mail. Our payment gateway is PCI compliant for your information protection.

**Purchase Orders:** Purchase orders from established customers may be submitted verbally, by fax or by e-mail. Your PO will be acknowledged with an expected shipping date.

**Verbal Orders:** Call 610-906-3549. Customers accept responsibility for errors on verbal orders not confirmed by an e-mail or fax confirmation.

**Minimum Order Value and Minimum Order Quantity:** Minimum order value is \$50.00. Some products may have a *Minimum Order Quantity* (MOQ) such as a full spool, full coil, full carton, etc. If an order for a particular item is less than the minimum order value, then a surcharge may be applied to bring the order up to the \$50.00 minimum order value.

**Most Orders Shipped Same Day:** The vast majority of products are always in stock and can ship same day providing you order on-line, by fax or call by 1 PM EST. Many items can ship same day if ordered by 3PM; and some items may be available for shipping same day if ordered by 4:30 PM (may incur an expedite fee). Fabricated items require more time – please call for a fabrication quote. Tadpole Tapes, Sleeve with Velcro and Welding Curtains can typically be produced in 2 to 4 days, however it can run 5 to 10 business days for large orders or if we are particularly busy. Other fabrications with complex shapes can take up to 15 business days. Please call for an estimate.

**Shipping:** Unless otherwise specified, orders will be shipped UPS ground, prepaid and billed or collect on your account. Other carriers such as FedEx and USPS are available. For Dealers or Distributors, Blind or Drop shipping to your customer is available – please specify on your PO if you will be providing a Packing List and send it to us ASAP. We can also use your carrier and account if you prefer.

**Customer Service Excellence:** We are focused on customer service; your assurance of the correct product, quality checked & delivered on-time. All products are RoHS compliant.

### AB Technology Group

CANADA Head Office: 116 Albert St, - Suite 300, Ottawa, ON K1P 5G3

USA Mail: 431 State Street Box 1491 Ogdensburg, NY 13669



**High Temperature, Heat, Flame, Fire, Molten Metal & Weld Splatter Protection Materials**

*Fax Orders: 610-340-9054 Telephone Orders: 610-906-3549 orders@abthermal.com*

---

---

# Sleeve / Jacket

FlameShield™ Firesleeve: Industrial 500°F / 260°C .....	1-1
FlameShield™ Firesleeve; Aviation / Aerospace SAE AS 1072 500°F / 260°C .....	1-3
FlameShield™ Firesleeve; Aviation / Aerospace SAE AS 1072. Marked .....	1-4
FlameShield™ Firesleeve; Aviation / Aerospace SAE AS 1072. NSN/NATO .....	1-5
FlameShield™ Firesleeve; Marine ISO 15540 500°F / 260°C .....	1-6
FlameShield™ Firesleeve; MSHA IC-366/01 Mining Approved 500°F / 260°C .....	1-7
FlameShield™ Firesleeve Technical Data .....	1-8
Firesleeve Accessories; End Seal Dip / End Seal Paste .....	1-9
Firesleeve Accessories; End Wrap Tape .....	1-10
Firesleeve Accessories; Stainless Steel Clamps & Clamp Tools .....	1-11
FlameShield™ HiFlex Firesleeve with VELCRO® Brand Hook & Loop Closure 500°F / 260°C .....	1-17
SplashGard™ HD LoFlex Firesleeve with VELCRO® Brand Hook & Loop Closure 500°F / 260°C .....	1-20
Aviation Firesleeve with Flame Retardant Hook & Loop Closure .....	1-23
FlameShield™ Firesleeve with Snap Closures: Silicone Rubber Coated Fiberglass Sleeve 500°F / 260°C .....	1-25
FlameShield™ Firesleeve with Zipper Closure: Silicone Rubber Coated Fiberglass Sleeve 500°F / 260°C .....	1-27
Small Diameter AWG Firesleeve: Silicone Rubber Coated Fiberglass Sleeve 464°F / 240°C.....	1-29
Small Diameter AWG HD Firesleeve: Silicone Rubber Coated Fiberglass Sleeve 464°F / 240°C.....	1-32
Fiberglass Braided Hermetic Sleeve – AWG Sized with Acrylic Copolymer 266°F / 130°C .....	1-34
Fiberglass Braided Sleeve – AWG Sized with Silicone Resin Binder 392°F / 200°C .....	1-36
FlameShield™ Tuff-Flex Viton® coated small diameter sleeve 428°F / 220°C .....	1-38
StretchSleeve™ Silicone Rubber Coated Expandable Fiberglass Sleeve 550°F / 287°C .....	1-41
Fiberglass Braided Sleeve Coated with soft PTFE 550°F / 287°C .....	1-43
ScuffSleeve™ Fiberglass Sleeve Coated w/ PTFE Resin with Hook-Loop Closure 550°F / 287°C .....	1-45
FlameShield™ Braided Kevlar Sleeve 320°F / 160°C .....	1-47
FlameShield™ Braided Kevlar Sleeve Heavy Duty 320°F / 160°C .....	1-49
FlameShield™ Braided Kevlar Colored Sleeve 320°F / 160°C .....	1-50
Silicone Closed Cell Foam Sleeve 460°F / 237°C .....	1-52
EPDM Closed Cell Foam Sleeve 220°F / 104°C .....	1-53
FlameShield™ Braided Nomex Sleeve 450°F / 232°C .....	1-54
FlameShield™ Braided Nomex Split Sleeve 392°F / 200°C .....	1-55
DeltaGlass™ Plain Fiberglass Sleeve, Premium Knit 1100°F / 593°C .....	1-56
DeltaGlass™ Plain Fiberglass Sleeve, Premium Braid 1100°F / 593°C .....	1-57
DeltaGlass™ Plain Fiberglass Sleeve, Industrial Braid 1100°F / 593°C .....	1-58
DeltaGlass™ Fiberglass Braided Heat Treated Sleeve 1100°F / 593°C .....	1-59
DeltaGlass™ Fiberglass Braided High Bulk Texturized Sleeve 1100°F / 593°C .....	1-60
DeltaGlass™ Fiberglass Braided Saturated Sleeve 1100°F / 593°C .....	1-61
DeltaGlass™ E-Fiberglass Braided Precision Small Diameter Sleeve 1200°F / 648°C .....	1-63
DeltaGlass™ S-Fiberglass Braided Precision Small Diameter Sleeve 1200°F / 648°C .....	1-65
DeltaGlass™ Fiberglass Braided Precision Small Diameter Sleeve, Thick Wall 1100°F / 593°C .....	1-67
DeltaGlass™ Fiberglass Braided Precision Small Diameter Sleeve, Thin Wall 1100°F / 593°C .....	1-69
DeltaGlass™ Fiberglass Braided Precision Small Diameter Sleeve, Acrylic Coating 1100°F / 593°C .....	1-71
BlackMax™ Braided Fiberglass Exhaust Pipe Sleeve 1200°F / 648°C .....	1-74
DeltaGlass™ Fiberglass Sleeve with Graphite Impregnation 1100°F / 593°C .....	1-75





## Thermal, EMI/RFI & Abrasion Protection Materials

Fax Orders: 610-340-9054 Telephone Orders: 610-906-3549 orders@abthermal.com

ExhaustSock™ Basalt Fiber Knitted Conformable Exhaust Pipe Insulation Sleeve 1382°F / 750°C .....	1-76
Braided Carbon Fiber Sleeve .....	1-77
DeltaGlass™ Fiberglass Braided Sleeve with Vermiculite Coating 1500°F / 815°C .....	1-79
DeltaGlass™ Fiberglass Braided High Bulk Sleeve with Vermiculite Coating 1500°F / 815°C .....	1-81
ScuffSleeve™ Specialty Weld splatter Protection Sleeve w/ Velcro Closure .....	1-82
InSilMax™ Braided Silica Sleeve 1800°F / 982°C .....	1-83
InSilMax™ Heavy Wall Braided Silica Sleeve 1800°F / 982°C .....	1-84
InSilMax™ XT Braided Silica Sleeve 2000°F / 1093°C .....	1-85
CerMax™ Braided Ceramic Fiber Sleeve 2300°F / 1260°C .....	1-86
High Alumina Content Braided Sleeve 2300°F / 1260°C .....	1-87
Spark Plug & Ignition Wire Boot Protection Sleeve 1200°F / 648°C .....	1-88

### Heat Reflecting

FlameShield™ Aluminum Coated Heat Reflective Split Sleeve with Adhesive Closure – 1000°F / 537°C .....	1-89
FlameShield™ Aluminum Coated Heat Reflective Sleeve 1000°F / 537°C .....	1-90
FlameShield™ Aluminum Coated Heat Reflective Sleeve, Convolutd High Bulk 1000°F / 537°C .....	1-91
FlameShield™ Aluminum Coated Heat Reflective Tape Split Sleeve, Adhesive Closure 1000°F / 537°C .....	1-92
FlameShield™ Aluminum Foil Coated Fiberglass Heat Reflecting Sewn Sleeve 1000°F / 537°C .....	1-93
FlameShield™ Aluminum Film Coated Fiberglass Heat Reflecting Sewn Sleeve 1000°F / 537°C .....	1-94
FlameShield™ Aluminum Foil Coated Fiberglass Heat Reflecting Sewn Sleeve w/ Hook Loop Closure 1000°F / 537°C .....	1-95
FlameShield™ Aluminum Film Coated Fiberglass Heat Reflecting Sewn Sleeve w/ Hook Loop Closure 1000°F / 537°C .....	1-96
FlameShield™ Aluminum Film Coated Fiberglass Heat Reflecting Sleeve w/ Zipper Closure 1000°F / 537°C .....	1-97
FlameShield™ Aluminum Foil Coated Fiberglass Heat Reflecting Sleeve metal snap closure .....	1-98
FlameShield™ Stainless Steel Coated Fiberglass Sewn Sleeve 1000°F / 537°C .....	1-99

### EMI/RFI Shielding

EMI / RFI Shielding Split Sleeve with earthing braid & snap closure .....	1-100
EMI / RFI / EMF Non Magnetic Shielding Split Sleeve with adhesive closure .....	1-101
FlameShield™ EMI / RFI Shield Sleeve .....	1-102

### Metalic Sleeve

FlameShield™ Tinned Copper Metal Braided Sleeve - Tubular .....	1-103
FlameShield™ Tinned Copper Metal Braided Sleeve - Flat .....	1-104
FlameShield™ Brass Meta Braided Sleeve - Tubular .....	1-108
HoseSaver™ / CableSaver™ Hose Size Stainless Steel Braided Sleeve 2500°F / 1371°C .....	1-109
HoseSaver™ / CableSaver™ Standard Size Stainless Steel Braided Sleeve 2500°F / 1371°C .....	1-110
Stainless Steel Hollow Mesh Sleeve 1200°F / 648°C .....	1-111
Solid Wall Stainless Steel Semi-Flexible Sleeve 1200°F / 648°C .....	1-112

### DUCTING

Exhaust Hose Ducting for Metal Fabrication / Refining / Smelting / Forging 1500°F / 815°C .....	1-113
Exhaust Hose Ducting for Welding Applications 300°F / 148°C.....	1-114
Overbraiding Service .....	1-115
Sleeve Size Table .....	1-116

**Also see Abrasion Protection Sleeve & Spiral Wrap in Section 6**

**FlameShield™ Firesleeve: High Temperature, Heat, Flame, Fire & Molten Metal Resistant Protection for Hoses, Cables and Wires**  
500°F / 260°C Continuous Rating – Higher Temperature for Shorter Periods  
Industrial Grade & Heavy Duty Grade: *Silicone Rubber Coated Fiberglass Sleeve*



**Protection from:**

- Heat
- Flame
- Fire
- Molten Metal Splash
- Welding Splatter & Sparks

**FlameShield™** firesleeve is the recognized standard for heat, flame and fire protection for hoses, tubing, cables and wiring in harsh environments. Ideal for electric cables and gas hoses in welding applications.

Utilized in most industries with hot processes, liquid metal or welding operations to protect assets and prevent failures, prolonging the life of critical hoses, wires and cables, and reduce unexpected shutdowns.

Also protects personnel from hot or cold hoses and pipes.

Firesleeve can be double sleeved or undersleeved with uncoated braided or knitted sleeves for additional thermal protection.

Industrial grade FlameShield™ firesleeve has minimal radial elasticity (approx 5%) while the Heavy Duty grade has approximately 20% of elasticity, allowing it to pass over couplings and connectors.

The Heavy Duty version sleeve is also used to cover water-cooled high current EAF cables and cooling water hoses at metal processing plants due to the excellent molten metal splash and slag protection. Both Industrial and Heavy Duty sleeve are extremely flexible, pliable and conformable. Used for fuel, brake, oil and hydraulic line / hose protection on mobile construction equipment, mining equipment, rail cars, buses and emergency response vehicles.

Also an excellent cold temperature sleeve with flexibility to -76°C. See further material specifications on Page 1-5.

S-FSHD up to 5" / 127mm ID meets standards: UL 1441 VW-1, DIN EN ISO 15540, EN 45545, NF F 16-101, BS 6853, NF X 10-702, NF X 70 100 & NF X 70 200, BS EN ISO 11925, BS EN ISO 4589-2, BS EN 60695-2-11, ASTM D 2863 OI, DD CEN/TS 45545-2, ASTM G85 Type 2.

Industrial Grade firesleeve is fabricated from a E-type glass yarn that is **knitted** and the Heavy Duty Grade is fabricated from a dense E-type yarn that is **braided**. Both the knitted and braided firesleeve receive a thick coating of self-extinguishing silicone rubber that withstands liquid metal splash, flame, slag, sparks, and other hazards in the toughest of environments.

Standard lengths are 100 feet; specific cut lengths are available. Standard colors are Oxide-Red in all sizes for both Industrial and Heavy Duty Grades, and Black is available in sizes from -04 through -32 in Heavy Duty Grade. Other colors may be available or can be ordered in lot quantity. Use ABST-LP-1 silicone rubber paint to add color markings. Nominal wall thickness is 0.140" for S-FSHD and 0.160" for S-FS.

## FlameShield™ Firesleeve

500°F / 260°C continuous rating with weld splatter / molten metal splash protection.  
 2200°F / 1205°C for periods up to 15 minutes and short excursions to 3000°F / 1650°C.

FlameShield™ High Temperature Firesleeve: Industrial grade and Heavy Duty grade								
Nominal ID Inches / mm / Dash #			Industrial Grade Part Number	Price per Foot	Price per Metre	Heavy Duty Grade Part Number	Price per Foot	Price per Metre
1/4	6	-04	S-FS-M006-04	\$ 2.96	\$ 9.68	S-FSHD-M006-04-X	\$ 3.37	\$ 11.02
5/16	8	-05	S-FS-M008-05	\$ 3.21	\$ 10.53	S-FSHD-M008-05-X	\$ 3.47	\$ 11.38
3/8	10	-06	S-FS-M010-06	\$ 3.37	\$ 11.02	S-FSHD-M010-06-X	\$ 3.68	\$ 12.03
7/16	11	-07	S-FS-M011-07	\$ 3.69	\$ 12.10	S-FSHD-M011-07-X	\$ 3.92	\$ 12.86
1/2	13	-08	S-FS-M013-08	\$ 3.97	\$ 12.98	S-FSHD-M013-08-X	\$ 4.36	\$ 14.26
9/16	15	-09	S-FS-M015-09	\$ 4.21	\$ 13.80	S-FSHD-M015-09-X	\$ 4.53	\$ 14.86
5/8	16	-10	S-FS-M016-10	\$ 4.34	\$ 14.19	S-FSHD-M016-10-X	\$ 4.67	\$ 15.32
11/16	17	-11	S-FS-M017-11	\$ 4.63	\$ 15.18	S-FSHD-M017-11-X	\$ 5.07	\$ 16.63
3/4	19	-12	S-FS-M019-12	\$ 4.88	\$ 15.96	S-FSHD-M019-12-X	\$ 5.34	\$ 17.52
13/16	20	-13	S-FS-M020-13	\$ 5.55	\$ 18.20	S-FSHD-M020-13-X	\$ 5.94	\$ 19.48
7/8	22	-14	S-FS-M022-14	\$ 5.82	\$ 19.03	S-FSHD-M022-14-X	\$ 6.33	\$ 20.76
1	25	-16	S-FS-M025-16	\$ 6.42	\$ 21.06	S-FSHD-M025-16-X	\$ 7.19	\$ 23.58
1 1/8	29	-18	S-FS-M029-18	\$ 7.25	\$ 23.78	S-FSHD-M029-18-X	\$ 8.12	\$ 26.63
1 1/4	32	-20	S-FS-M032-20	\$ 7.76	\$ 25.45	S-FSHD-M032-20-X	\$ 8.68	\$ 28.47
1 3/8	35	-22	S-FS-M035-22	\$ 7.81	\$ 25.62	S-FSHD-M035-22-X	\$ 8.75	\$ 28.70
1 1/2	38	-24	S-FS-M038-24	\$ 8.04	\$ 26.37	S-FSHD-M038-24-X	\$ 9.01	\$ 29.55
1 5/8	41	-26	S-FS-M041-26	\$ 8.17	\$ 26.80	S-FSHD-M041-26-X	\$ 9.14	\$ 29.98
1 3/4	44	-28	S-FS-M044-28	\$ 10.43	\$ 34.21	S-FSHD-M044-28-X	\$ 11.68	\$ 38.31
1 7/8	48	-30	S-FS-M048-30	\$ 11.50	\$ 37.72	S-FSHD-M048-30-X	\$ 13.63	\$ 44.71
2	51	-32	S-FS-M051-32	\$ 12.18	\$ 39.95	S-FSHD-M051-32-X	\$ 16.23	\$ 53.23
2 1/4	57	-36	S-FS-M057-36	\$ 14.49	\$ 47.53	S-FSHD-M057-36	\$ 18.67	\$ 61.24
2 3/8	60	-38	S-FS-M060-38	\$ 16.79	\$ 55.07	S-FSHD-M060-38	\$ 19.93	\$ 65.37
2 1/2	64	-40	S-FS-M064-40	\$ 18.83	\$ 61.76	S-FSHD-M064-40	\$ 21.10	\$ 69.21
2 5/8	67	-42	S-FS-M067-42	\$ 21.45	\$ 70.36	S-FSHD-M067-42	\$ 23.37	\$ 76.65
2 3/4	70	-44	S-FS-M070-44	\$ 24.11	\$ 79.08	S-FSHD-M070-44	\$ 24.45	\$ 80.20
2 7/8	73	-46	S-FS-M073-46	\$ 25.91	\$ 84.98	S-FSHD-M073-46	\$ 27.24	\$ 89.35
3	76	-48	S-FS-M076-48	\$ 27.21	\$ 89.25	S-FSHD-M076-48	\$ 28.98	\$ 94.99
3 1/4	83	-52	S-FS-M083-52	\$ 29.14	\$ 95.58	S-FSHD-M083-52	\$ 30.17	\$ 98.96
3 1/2	89	-56	S-FS-M089-56	\$ 31.26	\$ 102.53	S-FSHD-M089-56	\$ 31.94	\$ 104.76
3 3/4	95	-60	S-FS-M095-60	\$ 32.34	\$ 106.08	S-FSHD-M095-60	\$ 33.63	\$ 110.31
4	102	-64	S-FS-M102-64	\$ 32.65	\$ 107.09	S-FSHD-M102-64	\$ 35.83	\$ 117.52
4 1/2	114	-72	S-FS-M114-72	\$ 44.24	\$ 145.11	S-FSHD-M114-72	\$ 39.55	\$ 129.72
5	127	-80	S-FS-M127-80	\$ 47.92	\$ 157.18	S-FSHD-M127-80	\$ 42.53	\$ 139.50
5 1/2	140	-87	S-FS-M140-87	\$ 52.71	\$ 172.88	S-FSHD-M140-87	\$ 44.96	\$ 147.47
6	152	-96	S-FS-M152-96	\$ 57.50	\$ 188.60	S-FSHD-M152-96	\$ 47.03	\$ 154.26
8	203	-128	S-FS-M203-128	\$ 76.19	\$ 249.90	S-FSHD-M203-128	\$ 67.62	\$ 221.79
10	254	-160	S-FS-M254-160	\$ 95.84	\$ 314.35	S-FSHD-M254-160	\$ 85.06	\$ 278.99
12	305	-193	S-FS-M305-193	\$ 115.00	\$ 377.20	S-FSHD-M305-193	\$ 102.07	\$ 334.79
14	356	-225	S-FS-M356-225	\$ 134.17	\$ 440.07	S-FSHD-M356-225	\$ 119.08	\$ 390.58
16	406	-257	S-FS-M406-257	\$ 153.34	\$ 502.95	S-FSHD-M406-257	\$ 136.09	\$ 446.37

- For 6" ID and larger, the size is customizable - the sizes shown above in the table are example sizes and pricing. Sizes up to 120" ID are available - Priced by quotation.
- On-site custom fabrication over non-moveable or non-disconnectable hoses and pipes is available.

Standard color is Oxide-Red - other colors such as Black, Silver/Grey, Yellow, Green and Blue are available. Add the color code after the part number.  
 For the "-X" value above in the part number use "-OR" for Oxide-Red or "-BK" for Black

**Sizes up to 5" ID are available By-The-Foot / Metre or in standard 100 foot / 30 metre lengths**  
**Larger diameters up to 6" ID may also be available in 50 foot / 15 metre lengths**

**SAE AS1072 Aviation / Aerospace Firesleeve: High Temperature, Heat, Flame & Fire Resistant - without markings - Oxide-Red and Black**  
500°F / 260°C Continuous Rating – Higher Temperature for Shorter Periods  
Aviation / Aerospace Grade: Meets SAE AS1072 - Silicone Rubber Coated Fiberglass Sleeve



FlameShield™ Aviation / Aerospace grade firesleeve allows properly assembled hose assemblies to meet SAE AS1055D testing. We also maintain traceability records for customers buying this product. 500°F / 260°C continuous rating and with a 15 minute FAA “Fireproof” rating when assembled according to SAE AS1055.

This sleeve is extremely flexible, pliable and conformable. Typically used to protect fuel, oil, hydraulic lines and hoses, as well as critical wiring and cables. Remains flexible to -76°C (-104.8°F).

Firesleeve must be cut slightly longer than the hose or cable it is covering so it covers part of the fitting or connector. The longer the hose or cable, and if tight fitting, or if in use the hose/cable will be curved, then the longer the firesleeve needs to be. Firesleeve that is short will pull back from the fitting when the hose is bent, and if this occurs the hose assembly won't meet the TSO. Appropriate clamps must be used over the firesleeve at the fitting for aviation and Marine applications. (See our clamps and tools)

This sleeve has a radial elasticity of approximately 15% allowing it to slide over connectors, fittings and splices.

See further specifications on Page 1-6.

FlameShield™ S-AS1072 firesleeve also meets the following standards: UL 1441 VW-1, DIN EN ISO 15540, EN 45545, NF F 16-101, BS 6853, NF X 10-702, NF X 70 100 & NF X 70 200, BS EN ISO 11925, BS EN ISO 4589-2, BS EN 60695-2-11, ASTM D 2863 OI, DD CEN/TS 45545-2, ASTM G85 Type 2.

500°F / 260°C continuous rating, 800°F / 426°C for periods up to 30 minutes  
2200°F / 1205°C for periods up to 15 minutes and short excursions to 3000°F / 1650°C.

FlameShield™ AS1072 Aviation / Aerospace Grade Firesleeve									
Nominal ID Inches / mm / Dash #			Part Number	Price per Foot / Metre	Nominal ID Inches / mm / Dash #			Part Number	Price per Foot / Metre
1/4	6	-04	S-AS1072-M006-04-X	\$ 3.54 / \$ 11.61	1 3/4	44	-28	S-AS1072-M044-28-X	\$ 12.85 / \$ 42.15
5/16	8	-05	S-AS1072-M008-05-X	\$ 3.69 / \$ 12.10	1 7/8	48	-30	S-AS1072-M048-30-X	\$ 14.99 / \$ 49.17
3/8	10	-06	S-AS1072-M010-06-X	\$ 3.86 / \$ 12.66	2	51	-32	S-AS1072-M051-32-X	\$ 17.85 / \$ 58.55
7/16	11	-07	S-AS1072-M011-07-X	\$ 4.36 / \$ 14.30	2 1/4	57	-36	S-AS1072-M057-36	\$ 20.54 / \$ 67.37
1/2	13	-08	S-AS1072-M013-08-X	\$ 4.62 / \$ 15.15	2 3/8	60	-38	S-AS1072-M060-38	\$ 21.88 / \$ 71.77
9/16	15	-09	S-AS1072-M015-09-X	\$ 4.88 / \$ 16.01	2 1/2	64	-40	S-AS1072-M064-40	\$ 23.21 / \$ 76.13
5/8	16	-10	S-AS1072-M016-10-X	\$ 5.13 / \$ 16.83	2 5/8	67	-42	S-AS1072-M067-42	\$ 26.26 / \$ 86.13
11/16	17	-11	S-AS1072-M017-11-X	\$ 5.50 / \$ 18.04	2 3/4	70	-44	S-AS1072-M070-44	\$ 26.89 / \$ 88.20
3/4	19	-12	S-AS1072-M019-12-X	\$ 5.87 / \$ 19.25	2 7/8	73	-46	S-AS1072-M073-46	\$ 30.56 / \$ 100.24
13/16	20	-13	S-AS1072-M020-13-X	\$ 6.46 / \$ 21.19	3	76	-48	S-AS1072-M076-48	\$ 32.39 / \$ 106.24
7/8	22	-14	S-AS1072-M022-14-X	\$ 6.96 / \$ 22.83	3 1/4	83	-52	S-AS1072-M083-52	\$ 32.91 / \$ 107.95
1	25	-16	S-AS1072-M025-16-X	\$ 7.90 / \$ 25.91	3 1/2	89	-56	S-AS1072-M089-56	\$ 35.13 / \$ 115.23
1 1/8	29	-18	S-AS1072-M029-18-X	\$ 8.93 / \$ 29.29	3 3/4	95	-60	S-AS1072-M095-60	\$ 35.89 / \$ 117.72
1 1/4	32	-20	S-AS1072-M032-20-X	\$ 9.55 / \$ 31.32	4	102	-64	S-AS1072-M102-64	\$ 37.21 / \$ 122.05
1 3/8	35	-22	S-AS1072-M035-22-X	\$ 9.63 / \$ 31.59	4 1/2	114	-72	S-AS1072-M114-72	\$ 42.72 / \$ 140.12
1 1/2	38	-24	S-AS1072-M038-24-X	\$ 9.90 / \$ 32.47	5	127	-80	S-AS1072-M127-80	\$ 46.83 / \$ 153.60
1 5/8	41	-26	S-AS1072-M041-26-X	\$ 10.05 / \$ 32.96	6	162	-96	S-AS1072-M162-96	\$ 56.21 / \$ 184.37

For the “-X” value above in the part number, use “-OR” for Oxide-Red or “-BK” for Black

AS1072 Aerospace grade firesleeve is fabricated from a dense E-type braided sleeve and then receives a thick coating of self-extinguishing silicone rubber that withstands flame exposure, allowing qualified hose assemblies to meet FAA TSO-C42 (Propeller feathering hose assemblies), TSO-C53a (Fuel and Oil system hose assemblies) and TSO-C75 (Hydraulic hose assemblies). Standard lengths are 100 feet; specific cut lengths are available. Standard color is Oxide-Red in all sizes and Black is available in sizes -04 through -32. Nominal wall thickness is 0.16”.

**This product is available By-The-Foot / Metre or in standard 100 foot / 30 metre lengths**  
**Larger sizes available in 50 foot / 15 metre lengths**



## SAE AS1072 Aviation / Aerospace Firesleeve: High Temperature, Heat, Flame & Fire Resistant Type 2 with SAE Marking Silicone Rubber Composite 500°F / 260°C Continuous Rating – Higher Temperature for Shorter Periods



FlameShield™ Aviation / Aerospace grade firesleeve is manufactured to the SAE AS1072 specification. CofC and Test Report available with orders. Our company QMS has been reviewed and accepted by major aerospace OEMs. Allows properly assembled hose assemblies to meet SAE AS1055D testing. We also maintain traceability records for customers buying this product. 500°F / 260°C continuous rating and with a 15 minute FAA "Fireproof" rating when assembled according to SAE AS1055.

This sleeve is extremely flexible, pliable and conformable. Typically used to protect fuel, oil, hydraulic lines and hoses, as well as critical wiring and cables. Remains flexible to -76°C (-104.8°F).

Firesleeve must be cut slightly longer than the hose or cable it is covering so it covers part of the fitting or connector. The longer the hose or cable, and if tight fitting, or if in use the hose/cable will be curved, then the longer the firesleeve needs to be. Firesleeve that is short will pull back from the fitting when the hose is bent, and if this occurs the hose assembly won't meet the TSO. Appropriate clamps must be used over the firesleeve at the fitting for aviation and Marine applications. (See our clamps and tools)

This sleeve has a radial elasticity of approximately 15% allowing it to slide over connectors, fittings and splices.

For further specifications see Technical Data page 1-6. This sleeve is marked per the AS1072 specification. Other markings such as tradenames may be added.

FlameShield™ S-AS1072 firesleeve is also compliant to the following standards: UL 1441 VW-1, DIN EN ISO 15540, EN 45545, NF F 16-101, BS 6853, NF X 10-702, NF X 70 100 & NF X 70 200, BS EN ISO 11925, BS EN ISO 4589-2, BS EN 60695-2-11, ASTM D 2863 OI, DD CEN/TS 45545-2, ASTM G85 Type 2.

500°F / 260°C continuous rating, 800°F / 426°C for periods up to 30 minutes  
2200°F / 1205°C for periods up to 15 minutes and short excursions to 3000°F / 1650°C.

### FlameShield™ SAE AS1072 Aviation / Aerospace Grade Firesleeve with Marking

Nominal ID Inches / mm / Dash #			Part Number	Price per Foot / Metre	Nominal ID Inches / mm / Dash #			Part Number	Price per Foot / Metre
1/4	6	-04	AS1072-04 SIL-FG	\$ 3.99 / \$ 13.09	1 3/4	44	-28	AS1072-28 SIL-FG	\$ 13.88 / \$ 45.52
5/16	8	-05	AS1072-05 SIL-FG	\$ 4.17 / \$ 13.66	1 7/8	48	-30	AS1072-30 SIL-FG	\$ 16.19 / \$ 53.10
3/8	10	-06	AS1072-06 SIL-FG	\$ 4.34 / \$ 14.24	2	51	-32	AS1072-32 SIL-FG	\$ 19.28 / \$ 63.23
7/16	11	-07	AS1072-07 SIL-FG	\$ 4.88 / \$ 16.01	2 1/4	57	-36	AS1072-36 SIL-FG	\$ 22.18 / \$ 72.76
1/2	13	-08	AS1072-08 SIL-FG	\$ 5.16 / \$ 16.92	2 3/8	60	-38	AS1072-38 SIL-FG	\$ 23.63 / \$ 77.51
9/16	15	-09	AS1072-09 SIL-FG	\$ 5.44 / \$ 17.84	2 1/2	64	-40	AS1072-40 SIL-FG	\$ 25.07 / \$ 82.22
5/8	16	-10	AS1072-10 SIL-FG	\$ 5.71 / \$ 18.73	2 5/8	67	-42	AS1072-42 SIL-FG	\$ 28.36 / \$ 93.02
11/16	17	-11	AS1072-11 SIL-FG	\$ 6.11 / \$ 20.04	2 3/4	70	-44	AS1072-44 SIL-FG	\$ 29.04 / \$ 95.26
3/4	19	-12	AS1072-12 SIL-FG	\$ 6.51 / \$ 21.35	2 7/8	73	-46	AS1072-46 SIL-FG	\$ 33.01 / \$ 108.26
13/16	20	-13	AS1072-13 SIL-FG	\$ 7.11 / \$ 23.32	3	76	-48	AS1072-48 SIL-FG	\$ 34.98 / \$ 114.74
7/8	22	-14	AS1072-14 SIL-FG	\$ 7.69 / \$ 25.22	3 1/4	83	-52	AS1072-52 SIL-FG	\$ 35.54 / \$ 116.58
1	25	-16	AS1072-16 SIL-FG	\$ 8.70 / \$ 28.54	3 1/2	89	-56	AS1072-56 SIL-FG	\$ 37.94 / \$ 124.44
1 1/8	29	-18	AS1072-18 SIL-FG	\$ 9.55 / \$ 31.32	3 3/4	95	-60	AS1072-60 SIL-FG	\$ 38.76 / \$ 127.14
1 1/4	32	-20	AS1072-20 SIL-FG	\$ 10.48 / \$ 34.37	4	102	-64	AS1072-64 SIL-FG	\$ 40.19 / \$ 131.81
1 3/8	35	-22	AS1072-22 SIL-FG	\$ 11.33 / \$ 37.16	4 1/2	114	-72	AS1072-72 SIL-FG	\$ 46.14 / \$ 151.33
1 1/2	38	-24	AS1072-24 SIL-FG	\$ 12.18 / \$ 39.95	5	127	-80	AS1072-80 SIL-FG	\$ 50.58 / \$ 165.89
1 5/8	41	-26	AS1072-26 SIL-FG	\$ 13.03 / \$ 42.74	6	162	-96	AS1072-96 SIL-FG	\$ 60.69 / \$ 199.08

SAE AS1072 Aerospace grade firesleeve is fabricated from a dense E-type braided sleeve and then receives a thick coating of self-extinguishing silicone rubber that withstands flame exposure, allowing qualified hose assemblies to meet FAA TSO-C42 (Propeller feathering hose assemblies), TSO-C53a (Fuel and Oil system hose assemblies) and TSO-C75 (Hydraulic hose assemblies). Standard lengths are 100 feet; specific cut lengths are available. Standard color is Oxide-Red with black printing. Black sleeve with white printing is available. Other colors available.

This product is available **By-The-Foot / Metre** or in standard **100 foot / 30 metre** lengths  
Larger sizes available in **50 foot / 15 metre** lengths

**NSN / NATO Aerospace Sleeve meeting SAE AS1072  
Flame & Fire Resistant Type 2 with SAE Marking Silicone Rubber Composite  
for "Sleeve, hose assembly, fire protection"  
500°F / 260°C Continuous Rating – Higher Temperature for Shorter Periods**



FlameShield™ NSN / NATO firesleeve is manufactured to SAE AS1072 Aerospace specification. CofC and Test Report available with orders. Our company QMS has been reviewed and accepted by major aerospace OEMs. Allows properly assembled hose assemblies to meet SAE AS1055D testing. We also maintain traceability records for customers buying this product. 500°F / 260°C continuous rating and with a 15 minute FAA "Fireproof" rating when assembled according to SAE AS1055.

This sleeve is extremely flexible, pliable and conformable. Typically used to protect fuel, oil, hydraulic lines and hoses, as well as critical wiring and cables. Remains flexible to -76°C (-104.8°F).

Firesleeve must be cut slightly longer than the hose or cable it is covering so it covers part of the fitting or connector. The longer the hose or cable, and if tight fitting, or if in use the hose/cable will be curved, then the longer the firesleeve needs to be. Firesleeve that is short will pull back from the fitting when the hose is bent, and if this occurs the hose assembly won't meet the TSO. Appropriate clamps must be used over the firesleeve at the fitting for aviation and Marine applications. (See our clamps and tools)

This sleeve has a radial elasticity of approximately 15% allowing it to slide over connectors, fittings and splices.

For further specifications see Technical Data Page. This sleeve is marked per the AS1072 specification. Other markings such as tradenames, symbols, etc. may be added. Cage L8347.

FlameShield™ S-AS1072 firesleeve is also compliant to the following standards: UL 1441 VW-1, DIN EN ISO 15540, EN 45545, NF F 16-101, BS 6853, NF X 10-702, NF X 70 100 & NF X 70 200, BS EN ISO 11925, BS EN ISO 4589-2, BS EN 60695-2-11, ASTM D 2863 OI, DD CEN/TS 45545-2, ASTM G85 Type 2.

**500°F / 260°C continuous rating, 800°F / 426°C for periods up to 30 minutes  
2200°F / 1205°C for periods up to 15 minutes and short excursions to 3000°F / 1650°C.**

FlameShield™ NSN / NATO SAE AS1072 Aerospace Grade Sleeve with Marking													
Nominal ID Inches / mm / Dash #			Part Number (Yellow highlights NSN/NATO Spec)		Price per Foot / Metre		Nominal ID Inches / mm / Dash #			Part Number (Yellow highlights NSN/NATO Spec)		Price per Foot / Metre	
1/4	6	-04	AS1072-04 SIL-FG		\$ 3.99 / \$ 13.09	1 3/4	44	-28	5970-14-413-6220		\$ 13.88 / \$ 45.52		
5/16	8	-05	5970-14-455-2318		\$ 4.17 / \$ 13.66	1 7/8	48	-30	AS1072-30 SIL-FG		\$ 16.19 / \$ 53.10		
3/8	10	-06	5970-14-455-2322		\$ 4.34 / \$ 14.24	2	51	-32	5970-14-413-6221		\$ 19.28 / \$ 63.23		
7/16	11	-07	AS1072-07 SIL-FG		\$ 4.88 / \$ 16.01	2 1/4	57	-36	5970-14-413-6222		\$ 22.18 / \$ 72.76		
1/2	13	-08	5970-14-455-2324		\$ 5.16 / \$ 16.92	2 3/8	60	-38	AS1072-38 SIL-FG		\$ 23.63 / \$ 77.51		
9/16	15	-09	AS1072-09 SIL-FG		\$ 5.44 / \$ 17.84	2 1/2	64	-40	5970-14-455-2328		\$ 25.07 / \$ 82.22		
5/8	16	-10	5970-14-413-6212		\$ 5.71 / \$ 18.73	2 5/8	67	-42	AS1072-42 SIL-FG		\$ 28.36 / \$ 93.02		
11/16	17	-11	AS1072-11 SIL-FG		\$ 6.11 / \$ 20.04	2 3/4	70	-44	AS1072-44 SIL-FG		\$ 29.04 / \$ 95.26		
3/4	19	-12	5970-14-413-6213		\$ 6.51 / \$ 21.35	2 7/8	73	-46	AS1072-46 SIL-FG		\$ 33.01 / \$ 108.26		
13/16	20	-13	AS1072-13 SIL-FG		\$ 7.11 / \$ 23.32	3	76	-48	5970-14-455-2331		\$ 34.98 / \$ 114.74		
7/8	22	-14	5970-14-413-6214		\$ 7.69 / \$ 25.22	3 1/4	83	-52	AS1072-52 SIL-FG		\$ 35.54 / \$ 116.58		
1	25	-16	5970-14-413-6215		\$ 8.70 / \$ 28.54	3 1/2	89	-56	5970-14-455-2332		\$ 37.94 / \$ 124.44		
1 1/8	29	-18	AS1072-18 SIL-FG		\$ 9.55 / \$ 31.32	3 3/4	95	-60	AS1072-60 SIL-FG		\$ 38.76 / \$ 127.14		
1 1/4	32	-20	5970-14-413-6216		\$ 10.48 / \$ 34.37	4	102	-64	5970-14-455-2334		\$ 40.19 / \$ 131.81		
1 3/8	35	-22	AS1072-22 SIL-FG		\$ 11.33 / \$ 37.16	4 1/2	114	-72	AS1072-72 SIL-FG		\$ 46.14 / \$ 151.33		
1 1/2	38	-24	5970-14-413-6217		\$ 12.18 / \$ 39.95	5	127	-80	AS1072-80 SIL-FG		\$ 50.58 / \$ 165.89		
1 5/8	41	-26	AS1072-26 SIL-FG		\$ 13.03 / \$ 42.74	6	162	-96	AS1072-96 SIL-FG		\$ 60.69 / \$ 199.08		

SAE AS1072 Aerospace grade firesleeve is fabricated from a dense E-type braided sleeve and then receives a thick coating of self-extinguishing silicone rubber that withstands flame exposure, allowing qualified hose assemblies to meet FAA TSO-C42 (Propeller feathering hose assemblies), TSO-C53a (Fuel and Oil system hose assemblies) and TSO-C75 (Hydraulic hose assemblies). Standard lengths are 100 feet; specific cut lengths are available. Standard color is Oxide-Red with black printing. Black sleeve with white printing is available. Other colors available.

**This product is available By-The-Foot / Metre or in standard 100 foot / 30 metre lengths  
Larger sizes available in 50 foot / 15 metre lengths**



## DIN EN ISO15540 Marine Grade Firesleeve: High Temperature, Heat, Flame & Fire Resistant

500°F / 260°C Continuous Rating - 800°F / 426°C For Up To 30 Minutes

Marine Grade - Meets DIN EN ISO 15540 / USCG / SOLAS

Silicone Rubber Coated Fiberglass Sleeve



FlameShield™ Marine grade firesleeve allows properly assembled hose assemblies to meet ISO 15540 testing. We also maintain traceability records for customers buying this product. 500°F / 260°C continuous rating and with a 30 minute "Fireproof" 800°F / 426°C rating.

This sleeve is extremely flexible, pliable and conformable. Typically used to protect fuel, oil, hydraulic lines and hoses, as well as critical wiring and cables. Remains flexible to -76°C (-104.8°F).

Firesleeve must be cut slightly longer than the hose or cable it is covering so it covers part of the fitting or connector. The longer the hose or cable, and if tight fitting, or if in use the hose/cable will be curved, then the longer the firesleeve needs to be. Firesleeve that is short will pull back from the fitting when the hose is bent, and if this occurs the hose assembly won't meet the ISO standard. Appropriate clamps must be used over the firesleeve at the fitting for aviation and Marine applications. (See our clamps and tools)

This sleeve has a radial elasticity of approximately 15% allowing it to slide over connectors, fittings and splices.

S-ISO15540 also meets the following standards: UL 1441 VW-1, EN 45545, NF F 16-101, BS 6853, NF X 10-702, NF X 70 100 & NF X 70 200, BS EN ISO 11925, BS EN ISO 4589-2, BS EN 60695-2-11, ASTM D 2863 OI, DD CEN/TS 45545-2, ASTM G85 Type 2.

500°F / 260°C continuous rating, 800°F / 426°C for periods up to 30 minutes  
2200°F / 1205°C for periods up to 15 minutes and short excursions to 3000°F / 1650°C.

FlameShield™ DIN EN ISO15540 Marine Grade Firesleeve										
Nominal ID Inches / mm / Dash #			Part Number	Price per Foot / Metre	Nominal ID Inches / mm / Dash #			Part Number	Price per Foot / Metre	
1/4	6	-04	S-ISO15540-M006-04-X	\$ 3.54 / \$ 11.61	1 7/8	48	-30	S-ISO15540-M048-30-X	\$ 14.99 / \$ 49.17	
3/8	10	-06	S-ISO15540-M010-06-X	\$ 3.86 / \$ 12.66	2	51	-32	S-ISO15540-M051-32-X	\$ 17.85 / \$ 58.55	
7/16	11	-07	S-ISO15540-M011-07-X	\$ 4.36 / \$ 14.30	2 1/4	57	-36	S-ISO15540-M057-36	\$ 20.54 / \$ 67.37	
1/2	13	-08	S-ISO15540-M013-08-X	\$ 4.62 / \$ 15.15	2 1/2	64	-40	S-ISO15540-M064-40	\$ 23.21 / \$ 76.13	
9/16	15	-09	S-ISO15540-M015-09-X	\$ 4.88 / \$ 16.01	2 5/8	67	-42	S-ISO15540-M067-42	\$ 26.26 / \$ 86.13	
5/8	16	-10	S-ISO15540-M016-10-X	\$ 5.13 / \$ 16.83	2 3/4	70	-44	S-ISO15540-M070-44	\$ 26.89 / \$ 88.20	
3/4	19	-12	S-ISO15540-M019-12-X	\$ 5.87 / \$ 19.25	2 7/8	73	-46	S-ISO15540-M073-46	\$ 30.56 / \$ 100.24	
7/8	22	-14	S-ISO15540-M022-14-X	\$ 6.96 / \$ 22.83	3	76	-48	S-ISO15540-M076-48	\$ 32.39 / \$ 106.24	
1	25	-16	S-ISO15540-M025-16-X	\$ 7.90 / \$ 25.91	3 1/4	83	-52	S-ISO15540-M083-52	\$ 32.91 / \$ 107.95	
1 1/8	29	-18	S-ISO15540-M029-18-X	\$ 8.93 / \$ 29.29	3 1/2	89	-56	S-ISO15540-M089-56	\$ 35.13 / \$ 115.23	
1 1/4	32	-20	S-ISO15540-M032-20-X	\$ 9.55 / \$ 31.32	3 3/4	95	-60	S-ISO15540-M095-60	\$ 35.89 / \$ 117.72	
1 3/8	35	-22	S-ISO15540-M035-22-X	\$ 9.63 / \$ 31.59	4	102	-64	S-ISO15540-M102-64	\$ 37.21 / \$ 122.05	
1 1/2	38	-24	S-ISO15540-M038-24-X	\$ 9.90 / \$ 32.47	4 1/2	114	-72	S-ISO15540-M114-72	\$ 42.72 / \$ 140.12	
1 5/8	41	-26	S-ISO15540-M041-26-X	\$ 10.05 / \$ 32.96	5	127	-80	S-ISO15540-M127-80	\$ 46.83 / \$ 153.60	
1 3/4	44	-28	S-ISO15540-M044-28-X	\$ 12.85 / \$ 42.15						

For the "-X" value above in the part number, use "-OR" for Oxide-Red or "-BK" for Black

ISO15540 Marine grade firesleeve is fabricated from a dense E-type braided sleeve and then receives a thick coating of self-extinguishing silicone rubber that withstands flame exposure, allowing qualified hose assemblies to meet DIN EN ISO 15560 for fuel and lubricating oil marine systems.

Standard lengths are 100 feet; specific cut lengths are available. Standard color is Oxide-Red in all sizes and Black is available in sizes -04 through -32. Nominal wall thickness is 0.16".

**This product is available By-The-Foot / Metre or in standard 100 foot / 30 metre lengths  
Larger sizes available in 50 foot / 15 metre lengths**

**MSHA Approved Firesleeve for Mining Applications**  
High Temperature, Heat, Flame & Fire Resistant  
500°F / 260°C Continuous Rating - 800°F / 426°C For Up To 30 Minutes  
Silicone Rubber Coated Fiberglass Sleeve



FlameShield™ MSHA Mining approved firesleeve protects hoses and lines on mobile and fixed mining equipment. 500°F / 260°C continuous rating and with a 30 minute 800°F / 426°C rating.

This sleeve is extremely flexible, pliable and conformable. Typically used to protect fuel, oil, hydraulic lines and hoses, as well as critical wiring and cables. Remains flexible to -76°C (-104.8°F).

Firesleeve must be cut slightly longer than the hose or cable it is covering in such a manner that it covers part of the fitting or connector. The longer the hose or cable, and if tight fitting, or if in use the hose/cable will be curved, then the longer the firesleeve needs to be.

This sleeve has a radial elasticity of approximately 15% allowing it to slide over connectors, fittings and splices.

500°F / 260°C continuous rating, 800°F / 426°C for periods up to 30 minutes  
2200°F / 1205°C for periods up to 15 minutes and short excursions to 3000°F / 1650°C.

FlameShield™ MSHA Mining Approved Firesleeve										
Nominal ID Inches / mm / Dash #			Part Number	Price per Foot / Metre	Nominal ID Inches / mm / Dash #			Part Number	Price per Foot / Metre	
1/4	6	-04	S-FSHD-MSHA-M006-04	\$ 3.54 / \$ 11.61	1 7/8	48	-30	S-FSHD-MSHA-M048-30	\$ 14.99 / \$ 49.17	
3/8	10	-06	S-FSHD-MSHA-M010-06	\$ 3.86 / \$ 12.66	2	51	-32	S-FSHD-MSHA-M051-32	\$ 17.85 / \$ 58.55	
7/16	11	-07	S-FSHD-MSHA-M011-07	\$ 4.36 / \$ 14.30	2 1/4	57	-36	S-FSHD-MSHA-M057-36	\$ 20.54 / \$ 67.37	
1/2	13	-08	S-FSHD-MSHA-M013-08	\$ 4.62 / \$ 15.15	2 1/2	64	-40	S-FSHD-MSHA-M064-40	\$ 23.21 / \$ 76.13	
9/16	15	-09	S-FSHD-MSHA-M015-09	\$ 4.88 / \$ 16.01	2 5/8	67	-42	S-FSHD-MSHA-M067-42	\$ 26.26 / \$ 86.13	
5/8	16	-10	S-FSHD-MSHA-M016-10	\$ 5.13 / \$ 16.83	2 3/4	70	-44	S-FSHD-MSHA-M070-44	\$ 26.89 / \$ 88.20	
3/4	19	-12	S-FSHD-MSHA-M019-12	\$ 5.87 / \$ 19.25	2 7/8	73	-46	S-FSHD-MSHA-M073-46	\$ 30.56 / \$ 100.24	
7/8	22	-14	S-FSHD-MSHA-M022-14	\$ 6.96 / \$ 22.83	3	76	-48	S-FSHD-MSHA-M076-48	\$ 32.39 / \$ 106.24	
1	25	-16	S-FSHD-MSHA-M025-16	\$ 7.90 / \$ 25.91	3 1/4	83	-52	S-FSHD-MSHA-M083-52	\$ 32.91 / \$ 107.95	
1 1/8	29	-18	S-FSHD-MSHA-M029-18	\$ 8.93 / \$ 29.29	3 1/2	89	-56	S-FSHD-MSHA-M089-56	\$ 35.13 / \$ 115.23	
1 1/4	32	-20	S-FSHD-MSHA-M032-20	\$ 9.55 / \$ 31.32	3 3/4	95	-60	S-FSHD-MSHA-M095-60	\$ 35.89 / \$ 117.72	
1 3/8	35	-22	S-FSHD-MSHA-M035-22	\$ 9.63 / \$ 31.59	4	102	-64	S-FSHD-MSHA-M102-64	\$ 37.21 / \$ 122.05	
1 1/2	38	-24	S-FSHD-MSHA-M038-24	\$ 9.90 / \$ 32.47	4 1/2	114	-72	S-FSHD-MSHA-M114-72	\$ 42.72 / \$ 140.12	
1 5/8	41	-26	S-FSHD-MSHA-M041-26	\$ 10.05 / \$ 32.96	5	127	-80	S-FSHD-MSHA-M127-80	\$ 46.83 / \$ 153.60	
1 3/4	44	-28	S-FSHD-MSHA-M044-28	\$ 12.85 / \$ 42.15						

MSHA approved firesleeve is fabricated from a dense E-type braided sleeve and then receives a thick coating of self-extinguishing silicone rubber that withstands flame exposure.

Standard lengths are 100 feet; specific cut lengths are available. Standard color is Oxide-Red.

**This product is available By-The-Foot / Metre or in standard 100 foot / 30 metre lengths**  
**Larger sizes available in 50 foot / 15 metre lengths**

## FlameShield™ Firesleeve Technical Data

For Part Numbers S-FS / S-FSHD / S-FSHD-MSHA / S-AS1072 / S-ISO15540 / NSN-NATO

### Base Fiberglass Substrate – All Versions

Fiber Type:	E Glass
Specific Gravity:	2.54-2.69
Breaking Tenacity:	1.71 gf/TEX. Std. 1.71 gf/TEX Wet
Tensile Strength:	450,000-500,000 psi.
Breaking Elongation:	4.81% Std. 4.81% Wet
Elastic Recovery:	100%
Average Stiffness:	2824.3 cn/TEX

Effect of Heat: Will not burn; Retains 75% tensile at 343°C; Softens at 732-877°C; Melts at 1121-1182°C.

Effect of Acids and Alkalis; Resistance to acids is fair. Good resistance to most alkalis.

Effect of Bleaches and Solvents: Unaffected.

### Silicone Rubber Coating – All Versions

Durometer, Shore A:	Initial; 35	Aged 240 hours @ 200°C; 45
Tensile Strength (psi):	Initial; 875	Aged 240 hours @ 200°C; 800
Elongation %:	Initial; 500	Aged 240 hours @ 200°C; 200
Flammability, UL94; V-1		
Dielectric Strength (volts/mil); 485		

### Elasticity

S-FSHD: Linear elasticity of approximately 2% and a radial elasticity of approximately 15%.

S-FS: Linear elasticity of approximately 2% and a radial elasticity of approximately 2%.

### S-FSHD / S-AS1072 / S-ISO15540 sleeve meeting SAE AS1072 & DIN EN ISO15540 Specifications; Additional Data

#### Coating Thickness

AS1072 Specification: Minimum: .03" (0.8mm)

#### Fluid Resistance

Phosphate Ester hydraulic fluids	MIL-H-5606 hydraulic fluid
MIL-T-5624 Jet Fuel	MIL-L-6082 lubricating oil
MIL-L-7808 lubricating oil	MIL-L-23699 lubricating oil
MIL-H-83282 hydraulic fluid	

UL 1441 VW-1, EN 45545, NF F 16-101, BS 6853, NF X 10-702, NF X 70 100 & NF X 70 200, BS EN ISO 11925, BS EN ISO 4589-2, BS EN 60695-2-11, ASTM D 2863 OI, DD CEN/TS 45545-2, ASTM G85 Type 2.

### Printed/Marked Sleeve Options

FlameShield™ SAE AS1072 firesleeve is available unmarked but package labelled with the SAE nomenclature, or with SAE standard marking. Sleeve can also be printed/marked with other identification, part numbers, instructions, warnings, etc. Non standard SAE marking cost of an etched print wheel is \$275.00. A setup charge of \$75.00 per print run applies. Please enquire for cost of print run.



## End Dip & End Seal Paste for Firesleeve Sealing

### High Temperature & Heat Resistant Sealant For Industrial, Heavy Duty, Aerospace, Marine Grade Firesleeve



#### SleeveSeal™

##### End Seal Dip – Liquid Silicone Rubber

##### End Seal Paste – Silicone Rubber RTV

The ends of firesleeve can be sealed against the absorption of liquids by dipping the end in this liquid silicone rubber end dip sealant or by using end seal paste.

Available in any color: Oxide-Red and Black are the most common (other colors 1 gallon minimum).

Becomes tack free in 60 to 90 minutes and cures fully in 16 to 24 hours\*. Cure can be accelerated by increasing relative humidity and also adding heat.

500°F / 260°C rating once cured. Non-hazardous to ship. Liquid End Seal Dip may be thinned with odourless mineral spirits (xylene). Non corrosive and meets Mil-A-46146 as per NAVAIR 01-1A-20.

The 4 oz mini container opening can accommodate sleeve up to 1 3/4" ID.

The 16 oz container opening can accommodate sleeve up to 3 1/4" ID.

A Low VOC version is available: Maximum VOC is 20g/L.

SleeveSeal™ High Temperature Liquid End Seal Dip and End Seal Paste		
Quantity	Part Number	Price
Liquid End Seal Dip		
4 oz	US-ESD-04-XX	\$ 21.76
16 oz (Pint)	US-ESD-16-XX	\$ 46.47
32 oz (Quart)	US-ESD-32-XX	\$ 87.20
128 oz (1 gallon)	US-ESD-128-XX	\$ 229.32
128 oz (1 gallon)	US-ESD-LV-128-XX*	\$ 281.08
640 oz (5 gallon)	US-ESD-640-XX	\$ 988.40
End Seal Paste		
3 oz tube	US-ESP-03-XX	\$ 19.83
10.3 oz cartridge	US-ESP-10-XX	\$ 38.47
Desiccant Box		
1.5oz Desiccant in Box	AB-SGD-1	\$ 12.87

XX = "OR" for oxide-red or "BK" for black. Other colors are available for the Dip: min quantity is 1 gallon.

\* = Low VOC version.

### Desiccant Box



Desiccant box can be placed with uncured SleeveSeal™ Dip container in a sealed container or bag to considerably extend shelf life. Can be re-generated for unlimited re-use.

Perforated plastic box is approx 2 1/4" x 2 1/4" x 1". Total weight is 2.3oz (67g). Can be recharged at low temperature in an oven or microwave. Dry desiccant is blue in color and changes to pink as it absorbs moisture.



**Firesleeve EndWrap™ Tape / High Temperature Electrical Tape 500°F/260°C**  
**Silicone Rubber Self Fusing / Self Binding / Self Amalgamating Compression Tape**



FlameShield™ end wrap & electrical amalgamating compression tape is a unique adhesive-free tape which self-fuses / self-bonds within 24 hours or less at room temperature or shorter time at elevated temperatures when wrapped over itself, providing an excellent water-tight and air-tight seal.

Tape is adhesive free; leaves no residue when removed. Typically used to protect the free ends of firesleeve from wicking liquids once installed on hoses or cables. Also used for electrical wire and cable splice protection and protection of wires at connector shell clamp band locations. Exceptional electrical insulation resistance in a single wrap.

Tested to:

- ASTM D 149; tested for minimum 400 V/mil. for .010" to .030" thick tape, 300 V/mil for .040" thick tape and 250 V/mil for .060" thick tape.
- ASTM D 412; tested for minimum 700 psi tensile strength and minimum 300% elongation.
- ASTM D 2240; Durometer (Shore A); 55. Other test data available.

Using triangular profile tapes results in a smooth surface contour when spiral wrapped. The most common tapes are 1" wide triangular profile with either a 0.020" or 0.040" center thickness. Meets Mil-I-46852C & A-A-59163 specifications. Triangular tapes have a center guideline to aid in properly spacing the tape when spiral wrapping. T-SR-SA25 tape meets MIL-I-22444 and provides uniform thickness even on sharp corners and edges.

Tape part numbers ending in "BK" are Black color; "OR" are Oxide-Red color. Other colors are available by custom run.

<b>FlameShield™ High Temperature Silicone Self Fusing Firesleeve EndWrap™ Tape</b>				
<b>Meets MIL-I-46852 / A-A-59163 / ABS 5334 Specifications - Type I and Type II</b>				
<b>Part Number</b>	<b>Tape Width Inches / mm</b>	<b>Thickness inches / mm</b>	<b>Color / Type / Profile</b>	<b>Single Roll Price Per Roll</b>
T-SR-M013-08-RBK-20	1/2 / 12.7	0.020 / 0.508	Black / I / Rectangular	\$ 29.37
T-SR-M013-08-RXX-30	1/2 / 12.7	0.030 / 0.760	Black or Red / I / Rectangular	\$ 37.16
T-SR-M016-10-RBK-20	5/8 / 15.7	0.020 / 0.508	Black / I / Rectangular	\$ 30.17
T-SR-M019-12-ROR-10	3/4 / 19	0.010 / 0.254	Oxide-Red / I / Rectangular	\$ 23.85
T-SR-M019-12-RBK-20	3/4 / 19	0.020 / 0.508	Black / I / Rectangular	\$ 31.96
T-SR-M025-16-TXX-20	1 / 25.4	0.020 / 0.508	Black or Red / II / Triangular	\$ 33.80
T-SR-M025-16-RXX-20	1 / 25.4	0.020 / 0.508	Black or Red / I / Rectangular	\$ 34.71
T-SR-M025-16-TXX-40	1 / 25.4	0.040 / 1.000	Black or Red / II / Triangular	\$ 37.91
T-SR-M025-16-RXX-40	1 / 25.4	0.040 / 1.000	Black or Red / I / Rectangular	\$ 39.64
T-SR-M038-24-RXX-20	1 1/2 / 38.1	0.020 / 0.508	Black or Red / I / Rectangular	\$ 48.77
T-SR-M038-24-RXX-12	1 1/2 / 38.1	0.012 / 0.304	Black or Red / I / Rectangular	\$ 38.47
T-SR-M051-32-RXX-20	2 / 50.8	0.020 / 0.508	Black or Red / I / Rectangular	\$ 57.13
T-SR-M051-32-TXX-20	2 / 50.8	0.020 / 0.508	Black or Red / II / Triangular	\$ 48.86
<b>Triangular Type II Tapes Only: .020" has a blue guideline / .040" has a green guideline</b>				

<b>Supported Tape with Limited Elongation</b>				
<b>Meets MIL-I-22444 (also meets ABS 5334 Specifications)</b>				
<b>Part Number</b>	<b>Tape Width Inches / mm</b>	<b>Thickness inches / mm</b>	<b>Color / Type / Profile</b>	<b>Single Roll Price Per Roll</b>
T-SR-SA25-08-20-RXX*	1/2 / 12.7	0.020 / 0.508	Red or Black / I / Rectangular	\$ 49.76
T-SR-SA25-16-20-ROR*	1 / 25.4	0.020 / 0.508	Red or Black / I / Rectangular	\$ 67.29

\* NOTE: T-SR-SA25 tapes have an encapsulated sinusoidal weave fiberglass reinforcement layer, limiting stretch of the tape to a maximum of 25%, ensuring that the tape thickness remains constant over irregular surfaces and edges.

A Certificate of Conformity is available at \$6.00 per roll or \$25.00 per line item / batch-lot. Test report is available at \$75.00 per line item. This tape is also available meeting several other OEM and National Stock Number / NATO Stock Number specifications (available under military cage code is L8347).

These tapes are guaranteed to meet specification for 1 year from date of manufacture providing tapes are stored dry at 21°C +/- 3°C or 70°F +/- 5°F. Standard tapes have an interleaved liner of polyethylene (Mylar®). Polyester liner available.

## Firesleeve Accessories: Stainless Steel Clamps & Clamp Tools

### Type 201 Stainless Steel - 1/4" / 6.4mm wide



Preformed Stainless Steel Twice-Around clamps are the strongest clamps available for firesleeve or hose assembly. Use our Firesleeve Clamp Tool for closing and locking these clamps. Clamp widths available are 0.25", 0.375", 0.5", 0.625" and 0.75" wide. 0.25" wide clamps are type 201 stainless steel.

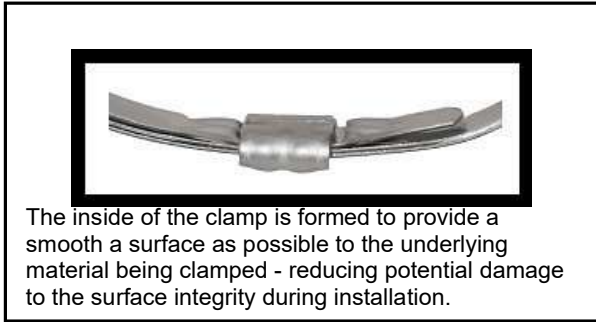

Free-end or twice-around clamps are used to secure firesleeve over hoses at the fitting. Twice-around clamps offer better tensile strength than free end clamps and provide superior clamping of hydraulic hoses onto fittings.

The inside of the clamp is formed to provide a smooth surface as possible to the underlying material being clamped - reducing potential damage to the surface integrity during installation.

<b>FlameShield™ Type 201 Stainless Steel Preformed Twice Around Clamps</b> 1/4" / 0.25" / 6.35mm wide - .020"/.51mm thick		
Part Number	Max Sleeve or Hose OD Inches / mm	Price Each
C-TA-250-13-201SS	13/16 / 20	\$ 2.84
C-TA-250-16-201SS	1 / 25	\$ 2.96
C-TA-250-22-201SS	1 3/8 / 34	\$ 3.12
C-TA-250-24-201SS	1 1/2 / 38	\$ 3.27
C-TA-250-32-201SS	2 / 51	\$ 3.48
C-TA-250-40-201SS	2 1/2 / 63	\$ 3.84
C-TA-250-44-201SS	2 3/4 / 70	\$ 4.01
C-TA-250-48-201SS	3 / 76	\$ 4.08
C-TA-250-56-201SS	3 1/2 / 88	\$ 4.40
C-TA-250-64-201SS	4 / 101	\$ 5.32
C-TA-250-72-201SS	4 1/2 / 114	\$ 6.28

Full box quantity is 100 clamps. Discount for full box purchase is 35%  
Half-box quantity is 50 clamps. Discount for half-box purchase is 25%



<b>FlameShield™ Type 201 / 316 Stainless Steel / Galvanized Carbon Steel Preformed Twice Around Clamps</b>		
<b>3/8" / 0.375" / 9.6mm wide - .025"/.64mm thick</b>		
<b>Part Number</b>	<b>Max Sleeve or Hose OD Inches / mm</b>	<b>Price Each 201 / 316 / Galv</b>
C-TA-375-13-X	13/16 / 20	\$ 2.46 / \$ 6.93 / \$ 0.93
C-TA-375-16-X	1 / 25	\$ 2.83 / N/A / \$ 1.00
C-TA-375-22-X	1 3/8 / 34	\$ 2.76 / \$ 7.60 / \$ 1.03
C-TA-375-32-X	2 / 51	\$ 3.13 / \$9.00 / \$1.30
C-TA-375-40-X	2 1/2 / 63	\$ 3.56 / \$ 10.26 / \$ 1.90
C-TA-375-48-X	3 / 76	\$ 4.00 / N/A / \$ 1.67
C-TA-375-56-X	3 1/2 / 88	\$ 4.93 / \$ 12.60 / \$ 2.40
C-TA-375-64-X	4 / 101	\$ 4.73 / \$ 14.03 / \$ 2.63

For the "X" value, substitute:

- "201SS" for 201 Stainless Steel
- "316SS" for 316 Stainless Steel
- "GAL" for Galvanized Carbon Steel

Full box quantity is 100 clamps. Discount for full box purchase is 35%  
 Half-box quantity is 50 clamps. Discount for half-box purchase is 25%

<b>FlameShield™ Type 201 / 316 Stainless Steel / Galvanized Carbon Steel Preformed Twice Around Clamps</b>		
<b>1/2" / 0.5" / 12.7mm wide - .030"/.76mm thick</b>		
<b>Part Number</b>	<b>Max Sleeve or Hose OD Inches / mm</b>	<b>Price Each 201 / 316 / Galv</b>
C-TA-500-16-X	1 / 25	\$ 3.43 / \$ 10.47 / \$ 1.33
C-TA-500-20-X	1 1/4 / 31	\$ 3.77 / \$ 11.43 / \$ 1.47
C-TA-500-24-X	1 1/2 / 38	\$ 4.33 / N/A / \$ 1.63
C-TA-500-28-X	1 3/4 / 44	\$ 4.93 / N/A / \$ 1.93
C-TA-500-32-X	2 / 51	\$ 5.16 / \$ 15.80 / \$ 2.00
C-TA-500-40-X	2 1/2 / 63	\$ 5.43 / \$ 16.87 / \$ 2.10
C-TA-500-44-X	2 3/4 / 69	\$ 5.70 / N/A / \$ 2.30
C-TA-500-48-X	3 / 76	\$ 6.30 / \$ 19.23 / \$ 2.53
C-TA-500-56-X	3 1/2 / 88	\$ 6.90 / \$ 21.20 / \$ 2.87
C-TA-500-64-X	4 / 101	\$ 7.53 / \$ 23.00 / \$ 3.23

For the "X" value, substitute:

- "201" for 201 Stainless Steel
- "316" for 316 Stainless Steel
- "GAL" for Galvanized Carbon Steel

Full box quantity is 100 clamps. Discount for full box purchase is 35%  
 Half-box quantity is 50 clamps. Discount for half-box purchase is 25%

<b>FlameShield™ Type 201 / 316 Stainless Steel / Galvanized Carbon Steel Preformed Twice Around Clamps</b>		
<b>5/8" / 0.625" / 15.9mm wide - .030"/.76mm thick</b>		
<b>Part Number</b>	<b>Max Sleeve or Hose OD Inches / mm</b>	<b>Price Each 201 / 316 / Galv</b>
C-TA-625-24-X	1 1/2 / 38	\$ 5.44 / \$ 16.56 / \$ 2.04
C-TA-625-28-X	1 3/4 / 38	\$ 6.04 / \$ 18.60 / \$ 2.28
C-TA-625-32-X	2 / 51	\$ 6.60 / \$ 20.40 / \$ 2.48
C-TA-625-36-X	2 1/4 / 57	\$ 7.04 / \$ 21.76 / \$ 2.64
C-TA-625-40-X	2 1/2 / 63	\$ 7.48 / \$ CALL / \$ 2.88

For the "X" value, substitute:

"201" for 201 Stainless Steel  
 "316" for 316 Stainless Steel  
 "GAL" for Galvanized Carbon Steel

Full box quantity is 100 clamps. Discount for full box purchase is 35%  
 Half-box quantity is 50 clamps. Discount for half-box purchase is 25%

<b>FlameShield™ Type 201 / 316 Stainless Steel / Galvanized Carbon Steel Preformed Twice Around Clamps</b>		
<b>3/4" / 0.75" / 19.1mm wide - .030"/.76mm thick</b>		
<b>Part Number</b>	<b>Max Sleeve or Hose OD Inches / mm</b>	<b>Price Each 201 / 316 / Galv</b>
C-TA-750-32-X	2 / 51	\$ 8.16 / \$ 25.60 / \$ 3.04
C-TA-750-44-X	2 3/4 / 69	\$ 8.88 / \$ 29.64 / \$ 3.44
C-TA-750-48-X	3 / 76	\$ 9.64 / \$ 30.96 / \$ 3.60
C-TA-750-56-X	3 1/2 / 88	\$ 10.24 / \$ 33.68 / \$ 3.92
C-TA-750-64-X	4 / 101	\$ 11.76 / \$ 36.32 / \$ 4.52
C-TA-750-72-X	4 1/2 / 114	\$ 12.64 / \$ 39.00 / \$ 4.76
C-TA-750-80-X	5 / 127	\$ 13.64 / \$ 41.68 / \$ 5.90
C-TA-750-84-X	5 1/4 / 133	\$ 14.16 / \$ 43.56 / \$ 6.10
C-TA-750-96-X	6 / 152	\$ 15.68 / \$ 48.16 / \$ 6.40
C-TA-750-100-X	6 1/4 / 165	\$ 17.28 / \$ N/A / \$ 6.56
C-TA-750-112-X	7 / 177	\$ CALL / \$ N/A / \$ 7.12
C-TA-750-128-X	8 / 203	\$ 21.28 / \$ N/A / \$ 10.08

For the "X" value, substitute:

"201" for 201 Stainless Steel  
 "316" for 316 Stainless Steel  
 "GAL" for Galvanized Carbon Steel

Full box quantity is 100 clamps. Discount for full box purchase is 35%  
 Half-box quantity is 50 clamps. Discount for half-box purchase is 25%

## Firesleeve Stainless Steel Clamps Free End Clamps & Clamp Tool



### Clamps – Stainless Steel; Free End; Self Locking

These stainless steel clamps are self locking and can be closed with common hand tools such as standard or needle nose pliers. A tighter clamping can be achieved with the Firesleeve Clamp Tools.

Clamps are available in two widths: .181" (tensile 96 lbs) and .311" (tensile 242 lbs). Clamps longer than 20" are available – call for details. Available in 304 and 316 Stainless Steel.

Free End Clamps – .181" / 5mm wide - 304/316 Stainless Steel – Self Locking					
Part Number	Max Sleeve ID Inches / mm	Clamp width inches / mm	Length inch / mm	Price 100 Bag 304 / 316	Price Each 304 / 316
C-SSSL-3XX-W181-L06-X	7/16 / 11	0.181 / 5.0	6" / 152	\$ 121.00 / \$ 139.00	\$ 1.82 / \$ 2.09
C-SSSL-3XX-W181-L08-X	1 1/8 / 28	0.181 / 5.0	8" / 203	\$ 139.00 / \$ 160.00	\$ 2.09 / \$ 2.40
C-SSSL-3XX-W181-L14-X	3 / 76	0.181 / 5.0	14" / 355	\$ 159.00 / \$ 183.00	\$ 2.39 / \$ 2.75
C-SSSL-3XX-W181-L20-X	5 / 127	0.181 / 5.0	20" / 508	\$ 211.00 / \$ 243.00	\$ 3.17 / \$ 3.65

Free End Clamps – .311" / 8mm wide - 304/316 Stainless Steel – Self Locking					
Part Number	Max Sleeve ID Inches / mm	Clamp width inches / mm	Length inch / mm	Price 100 Bag 304 / 316	Price Each 304 / 316
C-SSSL-3XX-W311-L08-X	1 1/8 / 28	0.311 / 8.0	8" / 203	\$ 159.00 / \$ 183.00	\$ 2.39 / \$ 2.75
C-SSSL-3XX-W311-L14-X	3 / 76	0.311 / 8.0	14" / 355	\$ 229.00 / \$ 263.00	\$ 3.44 / \$ 3.95
C-SSSL-3XX-W311-L20-X	5 / 127	0.311 / 8.0	20" / 508	\$ 387.00 / \$ 445.00	\$ 5.80 / \$ 6.68
C-SSSL-PPAP	Level 1 PAPP Certificate – (Per Line Item)			\$ 460.00	

Clamp Tool		
C-FCT-1		\$ 44.61

For the "X" value:  
substitute "04" for 304 Stainless Steel or "16" for 316 Stainless Steel

**Firesleeve Stainless Steel Clamps**  
*Free End Clamps & Clamp Tool*



**Firesleeve Clamp Tool**

Firesleeve Clamp Tool aids in the tightening of either style of clamp up to 3/8" wide. Built-in handles for the winder and cutter or a standard 1/2" wrench can be used for additional torque on the winder. The tool requires 4.5" of clamp free end for the winder to be properly loaded.

<b>Clamp Tool</b>		
C-FCT-1		\$ 44.61



Using FlameShield™ end wrap compression tape over the clamp makes for a neat and clean installation that prevents contamination of the sleeve end.

## Firesleeve Stainless Steel Preformed Twice Around Clamps – Smooth ID

### Dimensional Data

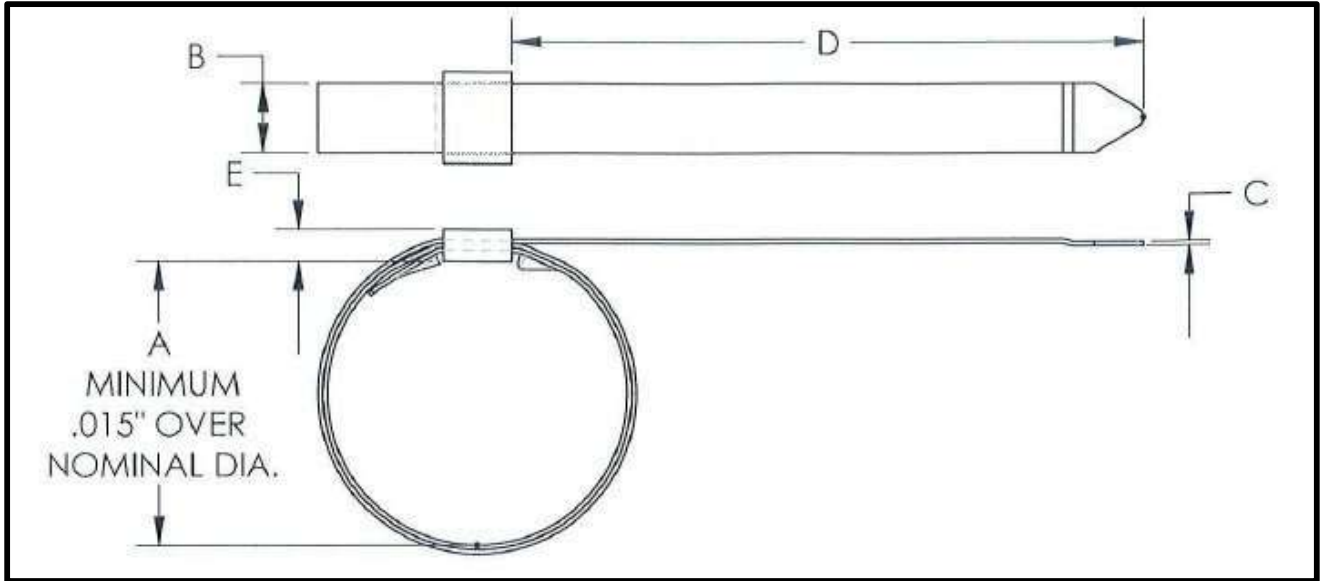

Twice Around Clamp Physical Dimensions and Material Specifications						
Part Number	Material Band / Buckle	Nominal I.D.	Width +/- .005	Thickne ss +/- .002	Tail Length	Buckle Height Max

## InsulDynamic™ HiFlex Firesleeve with VELCRO® Brand Hook & Loop Closure 500°F / 260°C Continuous Rating – Higher Temperature for Shorter Periods High Temperature, Heat, Flame, Fire, Weld Splatter and Molten Splash & Slag Resistant



InsulDynamic™ Firesleeve with flame retardant hook and loop or VELCRO® Brand closure is a high temperature heavy duty sleeve for protecting industrial hose and cable, but with the benefits of being installed & removed as required without disconnecting the hose, cable or wire.

The sleeve is fabricated from a braided base fabric (similar to our S-FSHD sleeve construction) which provides radial elasticity, easily accommodating connectors and splices.

Typical applications include:

- Electric Arc Furnace cable covers
- Robotic welding cable protection
- Steel mill roll-stand hydraulic hose protection
- Steel mill cooling water hose protection
- Vehicle under-hood wire, cable and hose protection or as a cover in extreme environments where serviceability is required.

The closure remains inside of the sleeve and is protected by the fabric overlap. The thread used is a high temperature e-fiberglass for installation with no or minimal flexing. A Nomex thread is used for installations subject to flexing.

Visit our website for a you tube video which compares the HiFlex and LoFlex versions..

Flame retardant hook & loop is utilized meeting MIL-F-21840, AA-55126, NFPA 1971-1991, FMVSS 302, FAA 25.853a. VELCRO® Brand hook and loop is also available.

This product may be suitable to protect personnel from hot pipe burns and OSHA compliance. Please contact our technical support in order to calculate temperature drop profile in your application.

Also an excellent cold temperature sleeve with flexibility to -76°C for refrigeration and cryogenic applications.

This is a custom fabrication item – please allow 3 to 10 business days from date of order. Contact us to determine the specific production time for your order.

The long edge of the sleeve has some fray of the underlying fiberglass, which does not affect the performance of the sleeve, and is only an aesthetic consideration.

The standard hook and loop and also VELCRO® Brand closure is a nylon material. Nomex® and Stainless Steel is available. For Nomex® add \$7.00 per foot to listed price. For Stainless Steel add \$36.00 per foot to listed price. Sleeve with Nomex® or Stainless Steel closure will have 1" wide closure material. Delivery time for other than standard will be a few additional days. See our catalog page for Nomex® and Stainless Steel closure for temperature ratings and other specifications.

Sizes larger than 5 inches ID contain an overlap seam of the base material opposite the closure location.



**InsulDynamic™ HiFlex Firesleeve with VELCRO® Brand Hook & Loop Closure**  
**500°F / 260°C Continuous Rating – Higher Temperature for Shorter Periods**  
**High Temperature, Heat, Flame, Fire, Weld Splatter and Molten Slag Resistant**



500°F / 260°C continuous rating with weld splatter / molten metal splash protection.  
 2200°F / 1205°C for periods up to 15 minutes and short excursions to 3000°F / 1650°C.

InsulDynamic™ HiFlex Firesleeve with VELCRO® Brand Hook / Loop Closure - Small Diameter						
Nominal ID inches / mm / Dash #			Part Number	Hook & loop Width, inches	Price per Foot	Price per Metre
1/2	13	-08	S-FS-VCL-M013-08	1/2	\$ 14.56	\$ 47.76
3/4	19	-12	S-FS-VCL-M019-12	1/2	\$ 17.34	\$ 56.88
1	25	-16	S-FS-VCL-M025-16	5/8	\$ 20.29	\$ 66.55
1 1/4	32	-20	S-FS-VCL-M032-20	5/8	\$ 22.60	\$ 74.13
1 1/2	38	-24	S-FS-VCL-M038-24	3/4	\$ 24.83	\$ 81.44
1 3/4	44	-28	S-FS-VCL-M044-28	3/4	\$ 26.77	\$ 87.81
2	51	-32	S-FS-VCL-M051-32	3/4	\$ 29.21	\$ 95.81
2 1/4	57	-36	S-FS-VCL-M057-36	3/4	\$ 31.23	\$ 102.43
2 1/2	64	-40	S-FS-VCL-M064-40	3/4	\$ 33.49	\$ 109.85
2 3/4	70	-44	S-FS-VCL-M070-44	3/4	\$ 35.80	\$ 117.42
3	76	-48	S-FS-VCL-M076-48	1	\$ 37.94	\$ 124.44
3 1/4	83	-52	S-FS-VCL-M083-52	1	\$ 40.34	\$ 132.32
3 1/2	89	-56	S-FS-VCL-M089-56	1	\$ 42.29	\$ 138.71
3 3/4	95	-60	S-FS-VCL-M095-60	1	\$ 44.51	\$ 145.99
4	102	-64	S-FS-VCL-M102-64	1	\$ 48.37	\$ 158.65
4 1/4	108	-68	S-FS-VCL-M108-68	1	\$ 50.54	\$ 165.77
4 1/2	114	-72	S-FS-VCL-M114-72	1	\$ 52.94	\$ 173.64
4 3/4	121	-76	S-FS-VCL-M121-76	1	\$ 55.17	\$ 180.96
5	127	-80	S-FS-VCL-M127-80	1	\$ 57.54	\$ 188.73

Available in continuous lengths up to 100 feet for up to 3.5" I.D.

Customer may specify a hook/loop width other than standard if desired (except for 1/2 and 3/4" sleeve).

Continued....

## InsulDynamic™ HiFlex Firesleeve with VELCRO® Brand Hook & Loop Closure (Continued)

### Large Diameter

**Large Diameter Firesleeve with VELCRO® Brand Hook & Loop Closure in sizes larger than 5 inches ID contains an overlap seam of the material opposite the closure location.**

500°F / 260°C continuous rating with weld splatter / molten metal splash protection.  
 2200°F / 1205°C for periods up to 15 minutes and short excursions to 3000°F / 1650°C.

<b>InsulDynamic™ Firesleeve with VELCRO® Brand Hook &amp; Loop Closure: Large Diameter</b>						
Nominal ID inches / mm / Dash #			Part Number	Hook/Loop Width, inches	Price per Foot	Price per Metre
5 1/4	133	-84	S-FS-VCL-M133-84	1	\$ 59.37	\$ 194.73
5 1/2	140	-88	S-FS-VCL-M140-88	1	\$ 61.66	\$ 202.25
5 3/4	146	-92	S-FS-VCL-M146-92	1	\$ 63.94	\$ 209.72
6	152	-96	S-FS-VCL-M152-96	1.5	\$ 66.11	\$ 216.84
6 1/4	159	-100	S-FS-VCL-M159-100	1.5	\$ 68.51	\$ 224.71
6 1/2	165	-104	S-FS-VCL-M165-104	1.5	\$ 70.74	\$ 232.03
6 3/4	171	-108	S-FS-VCL-M171-108	1.5	\$ 72.74	\$ 238.59
7	178	-112	S-FS-VCL-M178-112	1.5	\$ 74.97	\$ 245.90
7 1/4	184	-116	S-FS-VCL-M184-116	1.5	\$ 76.97	\$ 252.46
7 1/2	191	-120	S-FS-VCL-M191-120	1.5	\$ 79.54	\$ 260.89
7 3/4	197	-124	S-FS-VCL-M197-124	1.5	\$ 81.77	\$ 268.21
8	203	-128	S-FS-VCL-M203-128	2	\$ 83.69	\$ 274.50
8 1/4	210	-132	S-FS-VCL-M210-132	2	\$ 86.26	\$ 282.93
8 1/2	216	-136	S-FS-VCL-M216-136	2	\$ 88.43	\$ 290.05
8 3/4	222	-140	S-FS-VCL-M222-140	2	\$ 90.23	\$ 295.95
9	229	-144	S-FS-VCL-M229-144	2	\$ 92.57	\$ 303.63
9 1/4	235	-148	S-FS-VCL-M235-148	2	\$ 94.49	\$ 309.93
9 1/2	241	-152	S-FS-VCL-M241-152	2	\$ 97.20	\$ 318.82
9 3/4	248	-156	S-FS-VCL-M248-156	2	\$ 99.37	\$ 325.93
10	254	-160	S-FS-VCL-M254-160	2	\$ 101.66	\$ 333.45
10 1/4	260	-164	S-FS-VCL-M260-164	2	\$ 104.00	\$ 341.12
10 1/2	267	-168	S-FS-VCL-M267-168	2	\$ 105.60	\$ 346.37
10 3/4	273	-172	S-FS-VCL-M273-172	2	\$ 113.31	\$ 371.66
11	279	-176	S-FS-VCL-M279-176	2	\$ 115.66	\$ 379.36
11 1/4	286	-180	S-FS-VCL-M286-180	2	\$ 118.51	\$ 388.71
11 1/2	292	-184	S-FS-VCL-M292-184	2	\$ 122.37	\$ 401.37
11 3/4	298	-188	S-FS-VCL-M298-188	2	\$ 126.22	\$ 414.01
12	305	-192	S-FS-VCL-M305-192	2	\$ 129.41	\$ 424.46

Available in continuous lengths up to 100 feet. Larger Diameters available by quote.

The standard closure is nylon. A wider 2" hook and loop closure is available, which provides a greater adjustment range. Nomex® and Stainless Steel is available. For Nomex® add \$7.00 per foot to listed price and for Stainless Steel add \$36.00 per foot to listed price for 1" wide closure. For Nomex® add \$14.00 per foot to listed price and for Stainless Steel add \$72.00 per foot to listed price for 2" wide closure (2" wide stainless steel closure is constructed by using 2 x 1" wide strips). Delivery time for other than standard will be a few additional days. See our catalog page for Nomex® and Stainless Steel closure for temperature ratings and other specifications.

## SplashGard™ HD LoFlex Sleeve with VELCRO® Brand Hook & Loop Closure 500°F / 260°C Continuous Rating – Higher Temperature for Shorter Periods High Temperature, Heat, Flame, Fire, Weld Splatter and Molten Splash & Slag Resistant



SplashGard™ HD sleeve is a high temperature sleeve with a flame retardant hook and loop or VELCRO® Brand hook and loop closure that is suitable to protect hoses and cables from molten splash.

It may be installed and removed without disconnecting the hose, cable or wire. The sleeve is fabricated from a heavy duty woven fabric which is then coated with a thick layer of self extinguishing silicone rubber elastomer.

Due to the woven base material and deep elastomer impregnation, this material is stiff and provides no elasticity compared to our InsulDynamic version. This sleeve should be slightly oversized if it will require flexing or installation on curved installations. It is designed for straight or slightly curved sections or runs of hose, pipe or cables, and is difficult to use in a tightly curved path or one requiring high flexibility. Visit our website for a you tube video which compares the HiFlex and LoFlex versions..

Typical applications include protection of Electric Arc Furnace cables, robotic welding cables, steel mill roll-stand hydraulic hoses, steel mill cooling water hoses, vehicle under-hood wiring, cable and hoses. The same material is also used to fabricate custom protection covers for enclosures and equipment protection where serviceability is required.

The closure remains inside of the sleeve and is protected by the fabric overlap. Thread used is a high temperature e-fiberglass. Flame retardant hook & loop is utilized meeting MIL-F-21840, AA-55126, NFPA 1971-1991, FMVSS 302, FAA 25.853a.

This product may be suitable to protect personnel from hot pipe burns and OSHA compliance. Please contact our technical support in order to calculate temperature drop profile in your application.

Also an excellent cold temperature sleeve with flexibility to -76°C for refrigeration and cryogenic applications.

This is a custom fabrication item – please allow 3 to 10 business days from date of order. Contact us to determine the specific production time for your order.

The long edge of the sleeve has some fray of the underlying fiberglass, which does not affect the performance of the sleeve, and is only an aesthetic consideration.

The standard closure is nylon. Nomex® and Stainless Steel is available. For Nomex® add \$7.00 per foot to listed price. For Stainless Steel add \$36.00 per foot to listed price. Sleeve with Nomex® or Stainless Steel closure will have 1" wide closure material. Delivery time for other than standard will be a few additional days. See our catalog page for Nomex® and Stainless Steel closure for temperature ratings and other specifications.

**SplashGard™ HD LoFlex Sleeve with VELCRO® Brand Hook & Loop Closure**  
500°F / 260°C Continuous Rating – Higher Temperature for Shorter Periods  
High Temperature, Heat, Flame, Fire, Weld Splatter and Molten Slag Resistant



500°F / 260°C continuous rating with weld splatter / molten metal splash protection.  
2200°F / 1205°C for periods up to 15 minutes and short excursions to 3000°F / 1650°C.

**SplashGard™ HD Sleeve with VELCRO® Brand Hook / Loop Closure**  
**Small Diameter**

Nominal ID inches / mm / Dash #			Part Number	Hook & loop Width, inches	Price per Foot	Price per Metre
1 1/2	38	-24	S-FGSRHD-VCL-M038-24	3/4	\$ 24.83	\$ 81.44
1 3/4	44	-28	S-FGSRHD-VCL-M044-28	3/4	\$ 26.77	\$ 87.81
2	51	-32	S-FGSRHD-VCL-M051-32	3/4	\$ 29.21	\$ 95.81
2 1/4	57	-36	S-FGSRHD-VCL-M057-36	3/4	\$ 31.23	\$ 102.43
2 1/2	64	-40	S-FGSRHD-VCL-M064-40	3/4	\$ 33.49	\$ 109.85
2 3/4	70	-44	S-FGSRHD-VCL-M070-44	3/4	\$ 35.80	\$ 117.42
3	76	-48	S-FGSRHD-VCL-M076-48	1	\$ 37.94	\$ 124.44
3 1/4	83	-52	S-FGSRHD-VCL-M083-52	1	\$ 40.34	\$ 132.32
3 1/2	89	-56	S-FGSRHD-VCL-M089-56	1	\$ 42.29	\$ 138.71
3 3/4	95	-60	S-FGSRHD-VCL-M095-60	1	\$ 44.51	\$ 145.99
4	102	-64	S-FGSRHD-VCL-M102-64	1	\$ 48.37	\$ 158.65
4 1/4	108	-68	S-FGSRHD-VCL-M108-68	1	\$ 50.54	\$ 165.77
4 1/2	114	-72	S-FGSRHD-VCL-M114-72	1	\$ 52.94	\$ 173.64
4 3/4	121	-76	S-FGSRHD-VCL-M121-76	1	\$ 55.17	\$ 180.96
5	127	-80	S-FGSRHD-VCL-M127-80	1	\$ 57.54	\$ 188.73

Available in continuous lengths up to 100 feet for up to 3.5" I.D.

Customer may specify a hook/loop width other than standard if desired (except for 1/2 and 3/4" sleeve).

Continued...

## SplashGard™ HD LoFlex Sleeve with VELCRO® Brand Hook & Loop Closure (Continued) Large Diameter

**Large Diameter Firesleeve with VELCRO® Brand Hook & Loop Closure in sizes larger than 5 inches ID contains an overlap seam of the material opposite the closure.**

500°F / 260°C continuous rating with weld splatter / molten metal splash protection.  
 2200°F / 1205°C for periods up to 15 minutes and short excursions to 3000°F / 1650°C.

<b>SplashGard™ HD Sleeve with VELCRO® Brand Hook &amp; Loop Closure: Large Diameter</b>						
Nominal ID inches / mm / Dash #			Part Number	Hook/Loop Width, inches	Price per Foot	Price per Metre
5 1/4	133	-84	S-FGSRHD-VCL-M133-84	1	\$ 59.37	\$ 194.73
5 1/2	140	-88	S-FGSRHD-VCL-M140-88	1	\$ 61.66	\$ 202.25
5 3/4	146	-92	S-FGSRHD-VCL-M146-92	1	\$ 63.94	\$ 209.72
6	152	-96	S-FGSRHD-VCL-M152-96	1	\$ 66.11	\$ 216.84
6 1/4	159	-100	S-FGSRHD-VCL-M159-100	2	\$ 68.51	\$ 224.71
6 1/2	165	-104	S-FGSRHD-VCL-M165-104	2	\$ 70.74	\$ 232.03
6 3/4	171	-108	S-FGSRHD-VCL-M171-108	2	\$ 72.74	\$ 238.59
7	178	-112	S-FGSRHD-VCL-M178-112	2	\$ 74.97	\$ 245.90
7 1/4	184	-116	S-FGSRHD-VCL-M184-116	2	\$ 76.97	\$ 252.46
7 1/2	191	-120	S-FGSRHD-VCL-M191-120	2	\$ 79.54	\$ 260.89
7 3/4	197	-124	S-FGSRHD-VCL-M197-124	2	\$ 81.77	\$ 268.21
8	203	-128	S-FGSRHD-VCL-M203-128	2	\$ 83.69	\$ 274.50
8 1/4	210	-132	S-FGSRHD-VCL-M210-132	2	\$ 86.26	\$ 282.93
8 1/2	216	-136	S-FGSRHD-VCL-M216-136	2	\$ 88.43	\$ 290.05
8 3/4	222	-140	S-FGSRHD-VCL-M222-140	2	\$ 90.23	\$ 295.95
9	229	-144	S-FGSRHD-VCL-M229-144	2	\$ 92.57	\$ 303.63
9 1/4	235	-148	S-FGSRHD-VCL-M235-148	2	\$ 94.49	\$ 309.93
9 1/2	241	-152	S-FGSRHD-VCL-M241-152	2	\$ 97.20	\$ 318.82
9 3/4	248	-156	S-FGSRHD-VCL-M248-156	2	\$ 99.37	\$ 325.93
10	254	-160	S-FGSRHD-VCL-M254-160	2	\$ 101.66	\$ 333.45
10 1/4	260	-164	S-FGSRHD-VCL-M260-164	2	\$ 104.00	\$ 341.12
10 1/2	267	-168	S-FGSRHD-VCL-M267-168	2	\$ 105.60	\$ 346.37
10 3/4	273	-172	S-FGSRHD-VCL-M273-172	2	\$ 113.31	\$ 371.66
11	279	-176	S-FGSRHD-VCL-M279-176	2	\$ 115.66	\$ 379.36
11 1/4	286	-180	S-FGSRHD-VCL-M286-180	2	\$ 118.51	\$ 388.71
11 1/2	292	-184	S-FGSRHD-VCL-M292-184	2	\$ 122.37	\$ 401.37
11 3/4	298	-188	S-FGSRHD-VCL-M298-188	2	\$ 126.22	\$ 414.01
12	305	-192	S-FGSRHD-VCL-M305-192	1.5	\$ 129.41	\$ 424.46

Available in continuous lengths up to 100 feet. Larger Diameters available by quote.

The standard closure is nylon. Nomex® and Stainless Steel is available. For Nomex® add \$7.00 per foot to listed price and for Stainless Steel add \$36.00 per foot to listed price for 1" wide closure. For Nomex® add \$14.00 per foot to listed price and for Stainless Steel add \$72.00 per foot to listed price for 2" wide closure (2" wide is constructed by using 2 x 1" wide). Delivery time for other than standard will be a few additional days. See our catalog page for Nomex® and Stainless Steel closure for temperature ratings and other specifications.

## Aviation Firesleeve with Flame Retardant Hook & Loop Closure

500°F / 260°C Continuous Rating – Higher Temperature for Shorter Periods  
High Temperature, Heat, Flame & Fire Resistant



ZeusGard™ Firesleeve is a high temperature sleeve with YKK brand flame retardant hook and loop or VELCRO® Brand closure. SAE AS1072 firesleeve is used for construction of this retrofit sleeve which can be installed without disconnecting hoses, cables or wiring.

Typical applications are to protect fluid carrying hoses, cables and wires that are exposed to high temperatures or for additional protection in the event of fire. No guarantee is made as to the fire exposure time that this sleeve provides as it is modified from the AS1072 specification. Critical system components should be protected with standard AS1072 firesleeve without hook & loop closure.

The closure remains protected inside of the sleeve and is protected by the fabric overlap. The thread used is a high temperature e-fiberglass. Other threads such as stainless steel are available. The standard nylon hook and loop closure is flame retardant and meets MIL-F-21840, AA-55126, NFPA 1971-1991, FMVSS 302, FAA 25.853a.

To aid in keeping the firesleeve closed in the event of exposure to higher than rated temperatures or in the event of flame exposure, this sleeve should be further secured with metal band clamps spaced at regular intervals.

This is a custom fabrication item – please allow 2 to 5 business days from date of order. Contact us to determine the specific production time for your order.

The long edge of the sleeve has some fray of the underlying fiberglass, which does not affect the performance of the sleeve, and is only an aesthetic consideration.

The standard closure is nylon hook & loop. Nomex® and Stainless Steel is available. For Nomex® add \$7.00 per foot. For Stainless Steel add \$36.00 per foot. Sleeve with Nomex® or Stainless Steel closure will have 1" wide closure material. Delivery time for other than standard will be a few additional days. See our catalog page for Nomex® and Stainless Steel closures for temperature ratings and other specifications.



**Aviation Firesleeve with Flame Retardant Hook & Loop Closure (Continued)**  
**500°F / 260°C Continuous Rating – Higher Temperature for Shorter Periods**  
**High Temperature, Heat, Flame & Fire Resistant**



**500°F / 260°C continuous rating.**  
**2200°F / 1205°C for periods up to 15 minutes and short excursions to 3000°F / 1650°C.**

<b>ZeusGard™ Aviation Firesleeve with Hook &amp; Loop Closure</b>						
<b>Nominal ID inches / mm / Dash #</b>			<b>Part Number</b>	<b>Hook &amp; loop Width, inches</b>	<b>Price per Foot</b>	<b>Price per Metre</b>
1/2	13	-08	S-FS-VCL-AERO-M013-08	1/2	\$ 17.56	\$ 57.60
3/4	19	-12	S-FS-VCL-AERO-M019-12	1/2	\$ 20.34	\$ 66.72
1	25	-16	S-FS-VCL-AERO-M025-16	5/8	\$ 23.29	\$ 76.39
1 1/4	32	-20	S-FS-VCL-AERO-M032-20	5/8	\$ 25.60	\$ 83.97
1 1/2	38	-24	S-FS-VCL-AERO-M038-24	3/4	\$ 27.83	\$ 91.28
1 3/4	44	-28	S-FS-VCL-AERO-M044-28	3/4	\$ 29.77	\$ 97.65
2	51	-32	S-FS-VCL-AERO-M051-32	3/4	\$ 32.21	\$ 105.65
2 1/4	57	-36	S-FS-VCL-AERO-M057-36	3/4	\$ 34.23	\$ 112.27
2 1/2	64	-40	S-FS-VCL-AERO-M064-40	3/4	\$ 37.49	\$ 122.97
2 3/4	70	-44	S-FS-VCL-AERO-M070-44	3/4	\$ 38.80	\$ 127.26
3	76	-48	S-FS-VCL-AERO-M076-48	1	\$ 40.94	\$ 134.28
3 1/4	83	-52	S-FS-VCL-AERO-M083-52	1	\$ 43.34	\$ 142.16
3 1/2	89	-56	S-FS-VCL-AERO-M089-56	1	\$ 45.29	\$ 148.55
3 3/4	95	-60	S-FS-VCL-AERO-M095-60	1	\$ 47.21	\$ 154.85
4	102	-64	S-FS-VCL-AERO-M102-64	1	\$ 48.37	\$ 158.65
4 1/4	108	-68	S-FS-VCL-AERO-M108-68	1	\$ 50.54	\$ 165.77
4 1/2	114	-72	S-FS-VCL-AERO-M114-72	1	\$ 52.94	\$ 173.64
4 3/4	121	-76	S-FS-VCL-AERO-M121-76	1	\$ 55.17	\$ 180.96
5	127	-80	S-FS-VCL-AERO-M127-80	1	\$ 57.54	\$ 188.73

Available in continuous lengths up to 100 feet.

**Larger ID (Inside Diameter) Sizes Available - Please Ask**

## Firesleeve with Metal Snap Closure

**500°F / 260°C Continuous Rating – Higher Temperature for Shorter Periods**  
**High Temperature, Heat, Flame & Fire Resistant**

*Removable silicone rubber coated fiberglass sleeve with snap closure provides heavy duty weld splatter & molten splash protection*



SnapSleeve™ Firesleeve is a heavy duty silicone rubber coated fiberglass sleeve with snap style closures protects industrial wire, cable and hose with the benefits of being installed & removed as required. Typical applications are as robotic welding cable protection, steel mill roll-stand hydraulic hose protection or as a cover in extreme environments where serviceability is required. This is a custom fabrication item – please allow 3 to 10 business days from date of order. Available in continuous lengths up to 100 feet for IDs up to 3 ½” and 75 feet for IDs larger than 3 ¾”. Standard snap spacing is 3” but can be adjusted to the customer’s preference.

Also an excellent cold temperature sleeve with flexibility to -76°C for refrigeration and cryogenic applications.

**500°F / 260°C continuous rating with weld splatter / molten metal splash protection.**  
**2200°F / 1205°C for periods up to 15 minutes and short excursions to 3000°F / 1650°C.**

SnapSleeve™ Firesleeve with Metal Snap Closure					
Heavy Duty Removable Molten Splash Protection Sleeve					
Nominal ID inches / mm / Dash #			Part Number	Price Per Foot	Price Per Metre
1	25	-16	S-FS-SNAP-M025-16	\$ 20.29	\$ 66.55
1 1/4	32	-20	S-FS-SNAP-M032-20	\$ 22.60	\$ 74.13
1 1/2	38	-24	S-FS-SNAP-M038-24	\$ 24.83	\$ 81.44
1 3/4	44	-28	S-FS-SNAP-M044-28	\$ 26.77	\$ 87.81
2	51	-32	S-FS-SNAP-M051-32	\$ 29.00	\$ 95.12
2 1/4	57	-36	S-FS-SNAP-M057-36	\$ 31.23	\$ 102.43
2 1/2	64	-40	S-FS-SNAP-M064-40	\$ 33.49	\$ 109.85
2 3/4	70	-44	S-FS-SNAP-M070-44	\$ 35.80	\$ 117.42
3	76	-48	S-FS-SNAP-M076-48	\$ 37.94	\$ 124.44
3 1/4	83	-52	S-FS-SNAP-M083-52	\$ 40.34	\$ 132.32
3 1/2	89	-56	S-FS-SNAP-M089-56	\$ 42.29	\$ 138.71

**This Product is Available By-The-Foot / Metre. Larger IDs Available**

**Firesleeve with Metal Snap Closure (Continued)**  
**Large Diameter**



<b>SnapSleeve™ Firesleeve with Metal Snap Closure</b>					
<b>Heavy Duty Removable Molten Splash Protection Sleeve</b>					
<b>Nominal ID inches / mm / Dash #</b>			<b>Part Number</b>	<b>Price Per Foot</b>	<b>Price Per Metre</b>
3 3/4	95	-60	S-FS-SNAP-M095-60	\$ 44.51	\$ 145.99
4	102	-64	S-FS-SNAP-M102-64	\$ 48.37	\$ 158.65
4 1/4	108	-68	S-FS-SNAP-M108-68	\$ 50.54	\$ 165.77
4 1/2	114	-72	S-FS-SNAP-M114-72	\$ 52.94	\$ 173.64
4 3/4	121	-76	S-FS-SNAP-M121-76	\$ 55.17	\$ 180.96
5	127	-80	S-FS-SNAP-M127-80	\$ 57.54	\$ 188.73
5 1/4	133	-84	S-FS-SNAP-M133-84	\$ 59.37	\$ 194.73
5 1/2	140	-88	S-FS-SNAP-M140-88	\$ 61.66	\$ 202.25
5 3/4	146	-92	S-FS-SNAP-M146-92	\$ 63.94	\$ 209.72
6	152	-96	S-FS-SNAP-M152-96	\$ 66.11	\$ 216.84
6 1/4	159	-100	S-FS-SNAP-M159-100	\$ 68.51	\$ 224.71
6 1/2	165	-104	S-FS-SNAP-M165-104	\$ 70.74	\$ 232.03
6 3/4	171	-108	S-FS-SNAP-M171-108	\$ 72.74	\$ 238.59
7	178	-112	S-FS-SNAP-M178-112	\$ 74.97	\$ 245.90
7 1/4	184	-116	S-FS-SNAP-M184-116	\$ 76.97	\$ 252.46
7 1/2	191	-120	S-FS-SNAP-M191-120	\$ 79.54	\$ 260.89
7 3/4	197	-124	S-FS-SNAP-M197-124	\$ 81.77	\$ 268.21
8	203	-128	S-FS-SNAP-M203-128	\$ 83.69	\$ 274.50
8 1/4	210	-132	S-FS-SNAP-M210-132	\$ 86.26	\$ 282.93
8 1/2	216	-136	S-FS-SNAP-M216-136	\$ 88.43	\$ 290.05
8 3/4	222	-140	S-FS-SNAP-M222-140	\$ 90.23	\$ 295.95
9	229	-144	S-FS-SNAP-M229-144	\$ 92.57	\$ 303.63

**This Product is Available By-The-Foot / Metre. Larger IDs Available**

## Firesleeve with Metallic Zipper Closure - ZipSleeve™

**500°F / 260°C Continuous Rating – Higher Temperature for Shorter Periods**

**High Temperature, Heat, Flame & Fire Resistant Firesleeve**

*Removable silicone rubber coated fiberglass sleeve with metal zipper provides heavy duty weld splatter & molten splash protection that is removable and retrofit.*

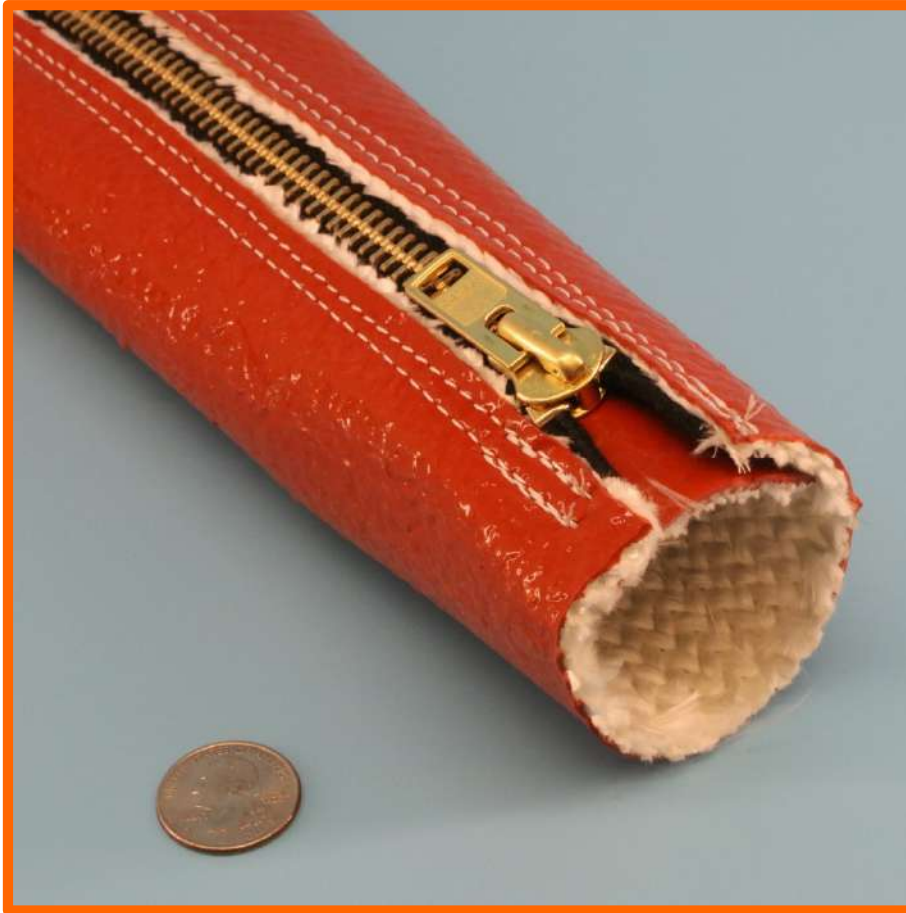

This heavy duty silicone rubber coated fibreglass sleeve with high temperature zipper closures protects industrial wire, cable and hose with the benefits of being installed & removed as required.

Typical applications are as robotic welding cable protection, steel mill roll-stand hydraulic hose protection or as a cover in extreme environments where serviceability is required.

The zipper is made from high temperature Nomex® fabric and metal teeth. This is a custom fabrication – please allow 3 to 10 business days from date of order.

The standard maximum length of a zipper is 50 feet / 15 metres. Longer zippers of up to 150 feet / 45 metres are possible, but will incur minimum order quantities. 500°F / 260°C continuous rating with weld splatter / molten metal splash protection.

Also an excellent cold temperature sleeve with flexibility to -76°C for refrigeration and cryogenic applications.

The sleeve has a special flap under the zipper to ensure the full protection of the cable or hose underneath.

For aviation and other critical applications, metal clamps secured at regular short intervals can be used to secure the sleeve in place in case of zipper failure due to a concentrated or prolonged heat or flame event.

Custom ZipSleeve™ can also be fabricated with a flap covering the zipper - sewn on one side and with a hook and loop closure on the other side of the flap.

**500°F / 260°C continuous rating with weld splatter / molten metal splash protection.  
2200°F / 1205°C for periods up to 15 minutes and short excursions to 3000°F / 1650°C.**

**Firesleeve with Metallic Zipper Closure (Continued)**  
500°F / 260°C Continuous Rating – Higher Temperature for Shorter Periods  
High Temperature, Heat, Flame & Fire Resistant Firesleeve



ZipSleeve™ Firesleeve					
Heavy Duty Removable Molten Splash Protection Sleeve					
Nominal ID inches / mm / Dash #			Part Number	Price Per Foot	Price Per Metre
1	25	-16	S-FS-ZC-M025-16	\$ 20.29	\$ 66.55
1 1/4	32	-20	S-FS-ZC-M032-20	\$ 22.60	\$ 74.13
1 1/2	38	-24	S-FS-ZC-M038-24	\$ 24.83	\$ 81.44
1 3/4	44	-28	S-FS-ZC-M044-28	\$ 26.77	\$ 87.81
2	51	-32	S-FS-ZC-M051-32	\$ 29.00	\$ 95.12
2 1/4	57	-36	S-FS-ZC-M057-36	\$ 31.23	\$ 102.43
2 1/2	64	-40	S-FS-ZC-M064-40	\$ 33.49	\$ 109.85
2 3/4	70	-44	S-FS-ZC-M070-44	\$ 35.80	\$ 117.42
3	76	-48	S-FS-ZC-M076-48	\$ 37.94	\$ 124.44
3 1/4	83	-52	S-FS-ZC-M083-52	\$ 40.34	\$ 132.32
3 1/2	89	-56	S-FS-ZC-M089-56	\$ 42.29	\$ 138.71
3 3/4	95	-60	S-FS-ZC-M095-60	\$ 44.51	\$ 145.99
4	102	-64	S-FS-ZC-M102-64	\$ 48.37	\$ 158.65
4 1/4	108	-68	S-FS-ZC-M108-68	\$ 50.54	\$ 165.77
4 1/2	114	-72	S-FS-ZC-M114-72	\$ 52.94	\$ 173.64
4 3/4	121	-76	S-FS-ZC-M121-76	\$ 55.17	\$ 180.96
5	127	-80	S-FS-ZC-M127-80	\$ 57.54	\$ 188.73
5 1/4	133	-84	S-FS-ZC-M133-84	\$ 59.37	\$ 194.73
5 1/2	140	-88	S-FS-ZC-M140-88	\$ 61.66	\$ 202.25
5 3/4	146	-92	S-FS-ZC-M146-92	\$ 63.94	\$ 209.72
6	152	-96	S-FS-ZC-M152-96	\$ 66.11	\$ 216.84
6 1/4	159	-100	S-FS-ZC-M159-100	\$ 68.51	\$ 224.71
6 1/2	165	-104	S-FS-ZC-M165-104	\$ 70.74	\$ 232.03
6 3/4	171	-108	S-FS-ZC-M171-108	\$ 72.74	\$ 238.59
7	178	-112	S-FS-ZC-M178-112	\$ 74.97	\$ 245.90
7 1/4	184	-116	S-FS-ZC-M184-116	\$ 76.97	\$ 252.46
7 1/2	191	-120	S-FS-ZC-M191-120	\$ 79.54	\$ 260.89
7 3/4	197	-124	S-FS-ZC-M197-124	\$ 81.77	\$ 268.21
8	203	-128	S-FS-ZC-M203-128	\$ 83.69	\$ 274.50
8 1/4	210	-132	S-FS-ZC-M210-132	\$ 86.26	\$ 282.93
8 1/2	216	-136	S-FS-ZC-M216-136	\$ 88.43	\$ 290.05
8 3/4	222	-140	S-FS-ZC-M222-140	\$ 90.23	\$ 295.95
9	229	-144	S-FS-ZC-M229-144	\$ 92.57	\$ 303.63

**This Product is Available By-The-Foot / Metre**



## Small Diameter Firesleeve style sleeve for Wiring, Cable and Tubing Protection

**Class 240 - Grade A-1 - 8000v Minimum Average / 6000v Minimum Individual - VW-1**

**464°F / 240°C Continuous Rating – Higher Temperature for Shorter Periods**

**High Temperature, Heat, Flame, Spark & Weld Splatter Resistant**

**Silicone Rubber Coated Fiberglass Sleeve with UL/CSA rating & NEMA TF-1**



FlameShield™ small diameter firesleeve style sleeving is designed as a primary insulation sleeve for protecting small diameter wire, cable, lines, hose, and pipe from high temperature, flame, spark, splatter and environmental contamination.

The thin wall braid and thin coating make the sleeve ideal for protection in space limited installations, while still providing exceptional protection and performance.

Recognized by UL / CSA for 240°C, 600V service, and complies with VW-1 flammability requirements. Conforms to, and is listed on the QPL for MIL-I-3190/9 (Grade A-1).

Extremely flexible and easily installed. Used in electrical apparatus as a primary or secondary wiring insulation.

The inner braid is very fine and dense, and along with the precision silicone rubber coating, this is the most flexible sleeve we have available for wire, cable and hose protection.

Due to the tight weave of this sleeve and the coating, it has negligible radial elasticity.

The coating of this sleeve provides excellent contamination resistance against oil, liquid splash, dust, grime, etc.

Depending on the sleeve diameter, this product is supplied in 100, 150 or 250 foot lengths on spools.

Some larger sleeves are supplied in shorter lengths or 3 foot long "sticks".



**Small Diameter Firesleeve style sleeve for Wiring, Cable and Tubing Protection (Continued)**  
**464°F / 240°C Continuous Rating – Higher Temperature for Shorter Periods**  
**High Temperature, Heat & Flame Resistant**

Available in all standard AWG wire sizes (see end of section): Available Colors are Oxide-Red and Black

<u>Property</u>	<u>Procedure</u>	<u>Performance</u>
<b>Physical</b>		
Tensile Strength, Coating	ASTM-D412	1600 psi
Ultimate Elongation, Coating	ASTM-D412	800% @ 20°C
Hardness, Coating	ASTM-D2240	54 (Durometer, Shore A)
Flexibility & Toughness, Coating	UL 1441	Passes Penetration Test
<b>Chemical</b>		
Oil & Solvent Resistance	MIL-I-3190/9	Passes
Water Vapour Resistance	MIL-I-3190/9	Passes
Resistance to Acids and Alkalis	-	Excellent
Resistance to Weathering	-	Unaffected by sunlight and weather
Compatibility	UL 1446	Good. Compatible with most potting compounds and varnishes
<b>Electrical</b>		
Dielectric Strength:		
after 48/23/50, Grade A	NEMA TF-1	8000V min avg., 6000v min individual
after 96/23/96, Grade A	NEMA TF-1	80% of Original Value
Hydrostatic Stability after 336 hrs @ 70°C over Constant Water Reflex	MIL-I-3190/9	Passes 7660V min avg with no disintegration, reversion or cracks (spec 5000V)
<b>Thermal</b>		
Thermal Endurance	MIL-I-3190/9 & UL 1441	Class 240°C (S)
Brittleness Temperature	ASTM-D350	-80°C
Flame Resistance	UL 1441	Passes (VW-1)
	ASTM-D350, Method A	Passes
	NEMA TF-1	Passes
	MIL-I-3190/9, Method A	Passes
Pushback	MIL-I-3190/9	No cracks or ruptures, 6000V min avg breakdown strength

**This product is not stock, it is made to order: Delivery is approximately 10 business days.**

**Small Diameter Firesleeve style sleeving (Continued)**  
**High Temperature, Heat & Flame Resistant Small**  
**Silicone Rubber Coated Fiberglass Sleeve**  
*Primary Insulation Silicone Rubber Coated Fiberglass Sleeve for*  
**Wire Protection, with UL/CSA approval rating and NEMA Grade TF-1 classified**

<b>High Temperature - Small Diameter – NEMA Wall Thickness Sleeve FlameShield™ Silicone Rubber Coated Fiberglass Sleeve with UL/CSA rating and NEMA Grade TF-1 Classification</b>						
Part Number	Nominal ID				Feet per Spool	Price per Spool
	AWG / Inches / mm / -dash					
S-FS-SD-AWG24-X	24	0.022	0.56		500*	\$ 488.05
S-FS-SD-AWG22-X	22	0.027	0.69		500*	\$ 490.17
S-FS-SD-AWG20-X	20	0.034	0.86		500*	\$ 505.01
S-FS-SD-AWG19-X	19	0.038	0.96		500*	\$ 510.02
S-FS-SD-AWG18-X	18	0.042	1.07		500*	\$ 525.65
S-FS-SD-AWG17-X	17	0.047	1.19		500*	\$ 535.27
S-FS-SD-AWG16-X	16	0.053	1.35		500*	\$ 545.79
S-FS-SD-AWG15-X	15	0.059	1.50		500*	\$ 550.33
S-FS-SD-AWG14-X	14	0.066	1.68	-01	500*	\$ 580.16
S-FS-SD-AWG13-X	13	0.076	1.93		250*	\$ 295.18
S-FS-SD-AWG12-X	12	0.085	2.16		250*	\$ 325.30
S-FS-SD-AWG11-X	11	0.095	2.41		250*	\$ 342.37
S-FS-SD-AWG10-X	10	0.106	2.69		250*	\$ 362.45
S-FS-SD-AWG9-X	9	0.118	3.10		250*	\$ 372.49
S-FS-SD-AWG8-X	8	0.133	3.38	-02	250*	\$ 402.61
S-FS-SD-AWG7-X	7	0.148	3.76		250*	\$ 430.72
S-FS-SD-AWG6-X	6	0.166	4.22		150*	\$ 274.83
S-FS-SD-AWG5-X	5	0.186	4.72	-03	150*	\$ 307.05
S-FS-SD-AWG4-X	4	0.208	5.28		150*	\$ 343.29
S-FS-SD-AWG3-X	3	0.234	5.94		150*	\$ 385.57
S-FS-SD-AWG2-X	2	0.263	6.68	-04	150*	\$ 454.03
S-FS-SD-AWG1-X	1	0.294	7.47		150*	\$ 520.47
S-FS-SD-05-X	5/16	0.313	7.95	-05	150*	\$ 567.78
S-FS-SD-AWG0-X	0	0.330	8.38		150	\$ 610.07
S-FS-SD-06-X	3/8	0.375	9.52	-06	150	\$ 853.69
S-FS-SD-07-X	7/16	0.438	11.12	-07	100	\$ 751.21
S-FS-SD-08-X	1/2	0.500	12.70	-08	100	\$ 877.72
S-FS-SD-10-X	5/8	0.625	15.87	-10	100	\$ 1068.93
S-FS-SD-12-X	3/4	0.750	19.05	-12	100	\$ 1258.32
S-FS-SD-14-X	7/8	0.875	22.22	-14	100	\$ 1534.66
S-FS-SD-16-X	1	1.000	25.40	-16	100	\$ 1874.27
S-FS-SD-18-X	1 1/8	1.125	28.57	-18	100	\$ 2603.51
S-FS-SD-20-X	1 1/4	1.250	31.75	-20	100	\$ 2974.78
S-FS-SD-22-X	1 3/8	1.375	34.92	-22	100	\$ 3241.36
S-FS-SD-23-X	1 7/16	1.437	36.49	-23	100	\$ 3583.26
S-FS-SD-24-X	1 1/2	1.500	38.10	-24	3***	\$ 39.83/foot (3' section)
S-FS-SD-26-X	1 5/8	1.625	41.27	-26	3***	\$ 42.99/foot (3' section)
S-FS-SD-28-X	1 3/4	1.750	44.45	-28	3***	\$ 46.46/foot (3' section)
S-FS-SD-30-X	1 7/8	1.875	47.62	-30	3***	\$ 50.17/foot (3' section)
S-FS-SD-32-X	2	2.000	50.80	-32	3***	\$ 57.31/foot (3' section)

See Page 1-43 for a table of pre-coated dimensional specifications for this product  
 For the "X" value in the part number, specify "B" for Black or "OR" for Oxide-Red Color.

**This product is available in full coils only.**  
**This product is not stock, it is made to order: Delivery is approximately 10 business days.**

\* Longer Spool Lengths Available. \*\* Minimum order 99 feet. \*\*\* Minimum order 60 feet.

Items highlighted in yellow are available by-the-foot. price is 2x spool foot price

## Small Diameter HD Wall Thickness Firesleeve style sleeve for Wiring, Cable and Tubing Protection

-112 to +392°F / -80 to +200°C Operating Temperature –  
Higher Temperature for Shorter Periods

High Temperature, Heat & Flame Resistant

*Heavy Wall Silicone Rubber Coated Fiberglass Sleeve with  
UL/CSA approved & NEMA TF-1 grade A*



FlameShield™ small diameter firesleeve with Heavy Wall Silicone Rubber coating is designed as a primary insulation sleeve for protecting small diameter wire, cable, lines, hose, and pipe from high temperature, flame and environmental contamination. Recognized by UL / CSA for 240°C, 600V service, and meets VW-1 flammability requirements.

Extremely flexible and easily installed. Used in electrical apparatus as a primary or secondary wiring insulation.

The inner braid is very fine and dense, and along with the precision silicone rubber coating, this is the most flexible sleeve we have available for wire, cable and hose protection.

Due to the tight weave of this sleeve and thick silicone coating, it has negligible radial elasticity.

The coating of this sleeve provides excellent contamination resistance against oil, liquid splash, etc.

**392°F / 200°C continuous rating with weld splatter / molten metal splash protection**

**Small Diameter HD Firesleeve style sleeve**  
**High Temperature, Heat & Flame Resistant Small**  
**Silicone Rubber Coated Fiberglass Sleeve**  
*Primary Insulation Silicone Rubber Coated Fiberglass Sleeve for*  
*Wire Protection, with UL/CSA approval rating and NEMA Grade TF-1 classified*

<b>High Temperature - Small Diameter – Heavy Wall Thickness Sleeve</b>						
<b>FlameShield™ Silicone Rubber Coated Fiberglass Sleeve with</b>						
<b>UL/CSA rating and NEMA Grade TF-1 Classification</b>						
Part Number	Nominal ID					Price per Spool
	NEMA AWG Size / Inches / mm / -dash					
S-FS-SD-HDW-AWG24-X	24	0.022	0.56			By Quote
S-FS-SD-HDW-AWG22-X	22	0.027	0.69			By Quote
S-FS-SD-HDW-AWG20-X	20	0.034	0.86			By Quote
S-FS-SD-HDW-AWG19-X	19	0.038	0.96			By Quote
S-FS-SD-HDW-AWG18-X	18	0.042	1.07			By Quote
S-FS-SD-HDW-AWG17-X	17	0.047	1.19			By Quote
S-FS-SD-HDW-AWG16-X	16	0.053	1.35			By Quote
S-FS-SD-HDW-AWG15-X	15	0.059	1.50			By Quote
S-FS-SD-HDW-AWG14-X	14	0.066	1.68	-01		By Quote
S-FS-SD-HDW-AWG13-X	13	0.076	1.93			By Quote
S-FS-SD-HDW-AWG12-X	12	0.085	2.16			By Quote
S-FS-SD-HDW-AWG11-X	11	0.095	2.41			By Quote
S-FS-SD-HDW-AWG10-X	10	0.106	2.69			By Quote
S-FS-SD-HDW-AWG9-X	9	0.118	3.10			By Quote
S-FS-SD-HDW-AWG8-X	8	0.133	3.38	-02		By Quote
S-FS-SD-HDW-AWG7-X	7	0.148	3.76			By Quote
S-FS-SD-HDW-AWG6-X	6	0.166	4.22			By Quote
S-FS-SD-HDW-AWG5-X	5	0.186	4.72	-03		By Quote
S-FS-SD-HDW-AWG4-X	4	0.208	5.28			By Quote
S-FS-SD-HDW-AWG3-X	3	0.234	5.94			By Quote
S-FS-SD-HDW-AWG2-X	2	0.263	6.68	-04		By Quote
S-FS-SD-HDW-AWG1-X	1	0.294	7.47			By Quote
S-FS-SD-HDW-05-X	5/16	0.313	7.95	-05		By Quote
S-FS-SD-HDW-AWG0-X	0	0.330	8.38			By Quote
S-FS-SD-HDW-06-X	3/8	0.375	9.52	-06		By Quote
S-FS-SD-HDW-07-X	7/16	0.438	11.12	-07		By Quote
S-FS-SD-HDW-08-X	1/2	0.500	12.70	-08		By Quote
S-FS-SD-HDW-10-X	5/8	0.625	15.87	-10		By Quote
S-FS-SD-HDW-12-X	3/4	0.750	19.05	-12		By Quote
S-FS-SD-HDW-14-X	7/8	0.875	22.22	-14		By Quote
S-FS-SD-HDW-16-X	1	1.000	25.40	-16		By Quote
S-FS-SD-HDW-18-X	1 1/8	1.125	28.57	-18		By Quote
S-FS-SD-HDW-20-X	1 1/4	1.250	31.75	-20		By Quote
S-FS-SD-HDW-24-X	1 1/2	1.500	38.10	-24		By Quote

See Page 1-43 for a table of pre-coated dimensional specifications for this product

For the "X" value in the part number, specify "B" for Black or "OR" for Oxide-Red Color.

**This product is available in full coils only.**

**This product is not stock, it is made to order: Delivery is approximately 10 business days.**



**Fiberglass Braided Hermetic Sleeve - AWG Wire Gauge Sized –  
Small Diameter - E Glass with high crosslinked acrylic copolymer  
266°F / 130°C: Continuous Rating – Higher Temperature for Shorter Periods  
DeltaGlass™ Class B Thermal Rating – Grade B-1 and C-1 Dielectric rating**



This high temperature and heat resistant braided hermetic fiberglass (fibreglass / glassfibre) sleeve, fabricated from high quality E-Type fiberglass filaments that will not burn and has been saturated with a high-crosslinked modified acrylic copolymer.

It will withstand continuous exposure to temperatures of 266°F / 130°C. It provides excellent protection for wires and wiring in hermetically sealed refrigeration compressor units.

Resistant to hydrochlorofluorocarbon (HCFC) refrigerants (R-22 and R-123) along with new hydrofluorocarbon (HFC) refrigerants such as R-134a. Compatible with mineral-oil lubricants such as Suniso® 3-G, along with synthetic polyol-ester lubricants such as Icematic® SW100 and alkylbenzene oils such as ZEROL® 150. This sleeve performs well with solvents such as methylene chloride, toluene, xylene and 1,1,1 trichlorethane.

This sleeve has been designed specifically for hermetic electric motors as its extremely low extraction levels of soluble materials protects against contamination and clogging within the compressor.

Conforms to NEMA TF-1, Type 2 and ASTM-D372.

**E-Glass Properties:**

Specific Gravity g/cm <sup>3</sup> :	2.55 - 2.58
Elongation at break, %:	4.5 - 4.9
Tensile strength, psi @22°C:	500,000 - 550,000
Water absorbency @22°C, 65% R.H.:	None
Space Factor Insulation, volts:	1100 (Std Wall) 1500 (HD wall)
Volume Resistivity at 22°C and 500 volts DC, ohm-cm:	10 <sup>15</sup> – 10 <sup>16</sup>
Dielectric Constant at 22°C, 60 Hz:	6.5 – 6.8
Dissipation Factor at 22°C, 1 MHz:	0.001 – 0.005

**Common Properties:**

- Good resistance to most acids and alkalis
- Unaffected by bleaches and solvents
- Excellent resistance to sunlight and aging. Not attacked by Mildew.
- Conforms to NEMA TF-1. Fibers conform to MIL-R-60346. Type IV, Class 1.

**This product is made to order: Delivery is approximately 5 to 15 business days.**

Suniso® is a registered trademark of Compton Corporation  
Icematic® is a registered trademark of Castrol, Inc.  
ZEROL® is a registered trademark of Shrieve Chemical Products Company

**Braided Fiberglass Hermetic Sleeve**  
*E-Glass Precision Small Diameter / Standard Wall Thickness*  
*with high-crosslinked acrylic copolymer*

Part Number	Nominal Size AWG / inch / mm / -dash				Price per Spool		Feet per Coil
					Grade B-1	Grade C-1	
S-FG-AHE-AWG24-X	24	0.022	0.56	NA	\$ 310.60	\$ 353.60	500'
S-FG-AHE-AWG22-X	22	0.027	0.69	NA	\$ 317.40	\$ 360.40	500'
S-FG-AHE-AWG20-X	20	0.034	0.86	NA	\$ 320.80	\$ 366.40	500'
S-FG-AHE-AWG19-X	19	0.038	0.96	NA	\$ 328.10	\$ 372.10	500'
S-FG-AHE-AWG18-X	18	0.042	1.07	NA	\$ 331.50	\$ 381.30	500'
S-FG-AHE-AWG17-X	17	0.047	1.19	NA	\$ 342.20	\$ 390.70	500'
S-FG-AHE-AWG16-X	16	0.053	1.35	NA	\$ 351.20	\$ 397.80	500'
S-FG-AHE-AWG15-X	15	0.059	1.50	NA	\$ 359.40	\$ 404.60	500'
S-FG-AHE-AWG14-X	14	0.066	1.68	-01	\$ 374.40	\$ 424.70	500'
S-FG-AHE-AWG13-X	13	0.076	1.93	NA	\$ 192.27	\$ 219.15	250'
S-FG-AHE-AWG12-X	12	0.085	2.16	NA	\$ 197.20	\$ 225.10	250'
S-FG-AHE-AWG11-X	11	0.095	2.41	NA	\$ 208.60	\$ 239.10	250'
S-FG-AHE-AWG10-X	10	0.106	2.69	NA	\$ 220.50	\$ 248.90	250'
S-FG-AHE-AWG9-X	9	0.118	3.10	NA	\$ 231.55	\$ 263.40	250'
S-FG-AHE-AWG8-X	8	0.133	3.38	-02	\$ 246.40	\$ 279.05	250'
S-FG-AHE-AWG7-X	7	0.148	3.76	NA	\$ 260.95	\$ 298.25	250'
S-FG-AHE-AWG6-X	6	0.166	4.22	NA	\$ 170.61	\$ 195.39	150'
S-FG-AHE-AWG5-X	5	0.186	4.72	-03	\$ 187.32	\$ 213.48	150'
S-FG-AHE-AWG4-X	4	0.208	5.28	NA	\$ 209.37	\$ 240.81	150'
S-FG-AHE-AWG3-X	3	0.234	5.94	NA	\$ 232.05	\$ 266.16	150'
S-FG-AHE-AWG2-X	2	0.263	6.68	-04	\$ 272.76	\$ 310.08	150'
S-FG-AHE-AWG1-X	1	0.294	7.47	NA	\$ 321.21	\$ 355.11	150'
S-FG-AHE-05-X	5/16	0.313	7.95	-05	\$ 346.38	\$ 394.53	150'
S-FG-AHE-AWG0-X	0	0.330	8.38	NA	\$ 365.61	\$ 416.88	150'
S-FG-AHE-06-X	3/8	0.375	9.52	-06	\$ 500.61	\$ 567.33	150'
S-FG-AHE-07-X	7/16	0.438	11.12	-07	\$ 440.98	\$ 499.80	100'
S-FG-AHE-08-X	1/2	0.500	12.70	-08	\$ 532.16	\$ 591.50	100'
S-FG-AHE-10-X	5/8	0.625	15.87	-10	\$ 632.60	\$ 712.58	100'
S-FG-AHE-12-X	3/4	0.750	19.05	-12	\$ 753.06	\$ 847.76	100'
S-FG-AHE-14-X	7/8	0.875	22.22	-14	\$ 921.94	\$ 1034.48	100'
S-FG-AHE-16-X	1	1.000	25.40	-16	\$ 1128.40	\$ 1265.42	100'

For the "X" value, specify "B1" or "C1"

See Size Table at the end of this catalog section for dimensional specifications

**This product is not stock, it is made to order: Delivery is approximately 5 to 15 business days.**

## Fiberglass Braided Sleeve - AWG Wire Gauge Sized – Small Diameter With Silicone Resin Binder

392°F / 200°C: Continuous Rating – Higher Temperature for Shorter Periods  
*DeltaGlass™ Very High Temperature & Heat Resistant Insulation with 650 volts  
space factor rating and NEMA TF-2 Section 6.3 flame resistance*



This is a high-strength, high-temperature fibreglass sleeve produced from E-Glass.

The braiding is tight and dense, providing excellent coverage over small wires, cables, hoses, tubes and pipes.

This product conforms to NEMA TF-2 and is made from fibers conforming to MIL-Y-1140 (latest version), Class C, Form 1 (continuous filament yarns). Meets VW-1 flammability requirements.

### E-Glass Properties:

Specific Gravity g/cm <sup>3</sup> :	2.55 - 2.58
Elongation at break, %:	4.5 - 4.9
Tensile strength, psi @22°C:	500,000 - 550,000
Water absorbency @22°C, 65% R.H.:	None
Space Factor Insulation, volts:	1100 (Std Wall) 1500 (HD wall)
Volume Resistivity at 22°C and 500 volts DC, ohm-cm:	10 <sup>15</sup> – 10 <sup>16</sup>
Dielectric Constant at 22°C, 60 Hz:	6.5 – 6.8
Dissipation Factor at 22°C, 1 MHz:	0.001 – 0.005

### Common Properties:

Good resistance to most acids and alkalies  
Unaffected by bleaches and solvents  
Excellent resistance to sunlight and aging. Not attacked by Mildew.  
Conforms to NEMA TF-2. Fibers conform to MIL-R-60346. Type IV, Class 1.

**This product is made to order: Delivery is approximately 5 to 15 business days.**

**Very High Temperature & Heat Resistant Fiberglass Braided Sleeve  
 with Silicone Resin Binder  
 with NEMA classification & Meets MIL-Y-1140 Class C Form 1  
 Meets UL 1441 VW-1 Flame Resistance**

Part Number	Nominal Size				Price per Spool	Feet per Spool
	AWG	inch	mm	-dash		
S-FG-SB-AWG24	24	0.022	0.56	NA	\$ 235.10	500'
S-FG-SB-AWG22	22	0.027	0.69	NA	\$ 241.20	500'
S-FG-SB-AWG20	20	0.034	0.86	NA	\$ 243.00	500'
S-FG-SB-AWG19	19	0.038	0.96	NA	\$ 244.10	500'
S-FG-SB-AWG18	18	0.042	1.07	NA	\$ 257.10	500'
S-FG-SB-AWG17	17	0.047	1.19	NA	\$ 259.00	500'
S-FG-SB-AWG16	16	0.053	1.35	NA	\$ 263.10	500'
S-FG-SB-AWG15	15	0.059	1.50	NA	\$ 272.00	500'
S-FG-SB-AWG14	14	0.066	1.68	-01	\$ 284.90	500'
S-FG-SB-AWG13	13	0.076	1.93	NA	\$ 144.00	250'
S-FG-SB-AWG12	12	0.085	2.16	NA	\$ 155.50	250'
S-FG-SB-AWG11	11	0.095	2.41	NA	\$ 167.35	250'
S-FG-SB-AWG10	10	0.106	2.69	NA	\$ 174.00	250'
S-FG-SB-AWG9	9	0.118	3.10	NA	\$ 184.85	250'
S-FG-SB-AWG8	8	0.133	3.38	-02	\$ 192.40	250'
S-FG-SB-AWG7	7	0.148	3.76	NA	\$ 206.25	250'
S-FG-SB-AWG6	6	0.166	4.22	NA	\$ 133.92	150'
S-FG-SB-AWG5	5	0.186	4.72	-03	\$ 148.23	150'
S-FG-SB-AWG4	4	0.208	5.28	NA	\$ 165.03	150'
S-FG-SB-AWG3	3	0.234	5.94	NA	\$ 177.21	150'
S-FG-SB-AWG2	2	0.263	6.68	-04	\$ 197.25	150'
S-FG-SB-AWG1	1	0.294	7.47	NA	\$ 219.69	150'
S-FG-SB-05	5/16	0.313	7.95	-05	\$ 236.49	150'
S-FG-SB-AWG0	0	0.330	8.38	NA	\$ 247.46	150'
S-FG-SB-06	3/8	0.375	9.52	-06	\$ 324.02	150'
S-FG-SB-07	7/16	0.438	11.12	-07	\$ 311.82	100'
S-FG-SB-08	1/2	0.500	12.70	-08	\$ 348.70	100'
S-FG-SB-10	5/8	0.625	15.87	-10	\$ 402.10	100'
S-FG-SB-12	3/4	0.750	19.05	-12	\$ 466.62	100'
S-FG-SB-14	7/8	0.875	22.22	-14	\$ 548.72	100'
S-FG-SB-16	1	1.000	25.40	-16	\$ 643.76	100'

Larger Sizes up to 2" ID Available

See Size Table at the end of this catalog section for dimensional specifications

**This product is not a stock item, it is made to order: Delivery is approximately 5 to 15 business days.**

## Viton® 231 Coated Fiberglass Sleeve: AWG Wire Sized High Temperature, Heat & Flame Resistant

428°F / 220°C: Continuous Rating – Higher Temperature for Shorter Periods  
Cut, Puncture & Abrasion / Wear Resistance

Available meeting NEMA Grade A-1, B-1 & C-1



FlameShield™ Tuff-Flex™ Viton® coated sleeve is designed as a primary insulation sleeve for protecting small diameter wire, cable, lines, hose, and pipe from high temperature, flame and environmental contamination. Recognized by UL / CSA for 220°C, 7000V service, and complies with VW-1 flammability requirements. Conforms to, and is listed on the QPL for MIL-I-3190/9. Available in 3 grades: NEMA Grade A-1, B-1 and C-1.

Extremely flexible and easily installed. Used in electrical apparatus as a primary or secondary wiring insulation. Suitable for use in silicone free requirement environments. Resistance to solvents, both aromatic and aliphatic; fuels, including JP-5; and oils, including Skydrol.

The inner fiberglass braid is very fine and dense, and along with the precision Viton® 231 coating, this is the toughest cut and abrasion resistant flexible sleeve we have available for wire, cable and hose protection.

428°F / 220°C: Continuous Rating – Higher Temperature for Shorter Periods  
Cut, Puncture & Abrasion / Wear Resistance





Viton® 231 Coated Fiberglass Sleeve: AWG Wire Sized
High Temperature, Heat & Flame Resistant (Continued)
428°F / 220°C: Continuous Rating – Higher Temperature for Shorter Periods
Cut, Puncture & Abrasion / Wear Resistance

Available in all standard AWG wire sizes (see end of this section): Available Colors are White, Black and Dark Tan (Natural).

Table with 3 columns: Property, Procedure, Performance. Rows include Physical, Chemical, and Electrical properties.

This product is not stock, it is made to order: Delivery is approximately 10 business days.

\* Do not use Ketone type solvents as a cleaning agent; use V.M. & P. Naphtha.



**Viton® 231 Coated Fiberglass Sleeve: AWG Wire Sized (Continued)**

**428°F / 220°C: High Temperature, Heat & Flame Resistant**

**Primary Insulation Viton® 231 Coated Fiberglass Sleeve for**

**Wire Protection, with UL/CSA approval rating and NEMA Grade A-1/B-1/C-1 classified**

<b>FlameShield™ High Temperature - Small Diameter – Viton® 231 Coated Fiberglass Sleeve with UL/CSA rating and NEMA Grade A-1 / B-1 / C-1 Classification. High Cut &amp; Abrasion Resistance</b>						
Part Number	Nominal ID				Feet per Spool	Price per 100 feet A-1 / B-1 / C-1
	AWG	Inches	mm	-dash		
S-FG-VI-AWG24-X-Y	24	0.022	0.56		500*	\$ 465.94 / 372.76 / 233.04
S-FG-VI-AWG22-X-Y	22	0.027	0.69		500*	\$ 470.26 / 376.24 / 235.02*
S-FG-VI-AWG20-X-Y	20	0.034	0.86		500*	\$ 603.00 / 482.40 / 301.50
S-FG-VI-AWG19-X-Y	19	0.038	0.96		500*	\$ 607.63 / 486.30 / 303.95
S-FG-VI-AWG18-X-Y	18	0.042	1.07		500*	\$ 618.80 / 495.22 / 309.27
S-FG-VI-AWG17-X-Y	17	0.047	1.19		500*	\$ 649.95 / 520.13 / 324.97
S-FG-VI-AWG16-X-Y	16	0.053	1.35		500*	\$ 670.95 / 537.11 / 335.33
S-FG-VI-AWG15-X-Y	15	0.059	1.50		500*	\$ 680.40 / 544.47 / 340.17
S-FG-VI-AWG14-X-Y	14	0.066	1.68	-01	500*	\$ 702.90 / 562.42 / 351.27
S-FG-VI-AWG13-X-Y	13	0.076	1.93		250*	\$ 716.90 / 573.75 / 358.55
S-FG-VI-AWG12-X-Y	12	0.085	2.16		250*	\$ 747.87 / 598.17 / 374.07
S-FG-VI-AWG11-X-Y	11	0.095	2.41		250*	\$ 784.57 / 627.67 / 392.25
S-FG-VI-AWG10-X-Y	10	0.106	2.69		250*	\$ 827.45 / 662.02 / 413.70
S-FG-VI-AWG9-X-Y	9	0.118	3.10		250*	\$ 874.32 / 699.42 / 437.40
S-FG-VI-AWG8-X-Y	8	0.133	3.38	-02	250*	\$ 930.37 / 744.27 / 465.20
S-FG-VI-AWG7-X-Y	7	0.148	3.76		250*	\$ 948.21 / 758.45 / 474.15
S-FG-VI-AWG6-X-Y	6	0.166	4.22		150*	\$ 981.20 / 785.10 / 490.62
S-FG-VI-AWG5-X-Y	5	0.186	4.72	-03	150*	\$ 1010.90 / 808.77 / 505.62
S-FG-VI-AWG4-X-Y	4	0.208	5.28		150*	\$ 1017.95 / 814.32 / 508.70
S-FG-VI-AWG3-X-Y	3	0.234	5.94		150*	\$ 1065.80 / 852.75 / 532.95
S-FG-VI-AWG2-X-Y	2	0.263	6.68	-04	150*	\$ 1097.75 / 878.17 / 548.85
S-FG-VI-AWG1-X-Y	1	0.294	7.47		150*	\$ 1266.72 / 1013.32 / 633.30
S-FG-VI-05-X-Y	5/16	0.313	7.95	-05	150*	\$ 1436.75 / 1149.22 / 718.35
S-FG-VI-AWG0-X-Y	0	0.330	8.38		150	\$ 1605.07 / 1284.12 / 802.47
S-FG-VI-06-X-Y	3/8	0.375	9.52	-06	150	\$ 1841.02 / 1472.75 / 920.52
S-FG-VI-07-X-Y	7/16	0.438	11.12	-07	100	\$ 2365.92 / 1892.70 / 1183.05
S-FG-VI-08-X-Y	1/2	0.500	12.70	-08	100	\$ 3242.62 / 2593.92 / 1621.20
S-FG-VI-10-X-Y	5/8	0.625	15.87	-10	100	\$ 3943.80 / 3155.10 / 1972.02
S-FG-VI-12-X-Y	3/4	0.750	19.05	-12	100	\$ 4556.25 / 3644.97 / 2278.12
S-FG-VI-14-X-Y	7/8	0.875	22.22	-14	100	\$ 5608.47 / 4486.62 / 2804.30
S-FG-VI-16-X-Y	1	1.000	25.40	-16	100	\$ 6834.82 / 5468.12 / 3417.42
S-FG-VI-18-X-Y	1 1/8	1.125	28.57	-18	100	\$ N/A / 6589.25 / 4118.15
S-FG-VI-20-X-Y	1 1/4	1.250	31.75	-20	100	\$ N/A / 7851.07 / 4906.80
S-FG-VI-22-X-Y	1 3/8	1.375	34.92	-22	3**	\$ N/A. / N/A / 6134.17
S-FG-VI-23-X-Y	1 7/16	1.437	36.49	-23	3**	\$ N/A. / N/A / 6572.31
S-FG-VI-24-X-Y	1 1/2	1.500	38.10	-24	3**	\$ N/A. / N/A / 7010.82
S-FG-VI-26-X-Y	1 5/8	1.625	41.27	-26	3**	\$ N/A. / N/A / 7404.66
S-FG-VI-28-X-Y	1 3/4	1.750	44.45	-28	3**	\$ N/A. / N/A / 7799.31
S-FG-VI-30-X-Y	1 7/8	1.875	47.62	-30	3**	\$ N/A. / N/A / 8412.27
S-FG-VI-32-X-Y	2	2.000	50.80	-32	3**	\$ N/A. / N/A / 8982.45

Quantity Pricing: For 1000 to 4999 feet -10% / For 5000 feet or more -17%  
 See end of section 1 for a table of pre-coated dimensional specifications for this product

For the "X" value, specify "A1", "B1" or "C1"  
 For the "Y" value in the part number, specify "B" for Black or "W" for White or "N" for Natural (Dark Tan)

**This product is available in full coils only.**  
**This product is not generally stock: Delivery is approximately 15 business days.**

\* Longer Spool Lengths Available. \*\* Minimum order 30 pieces

## High Elasticity Firesleeve

392°F / 200°C: Continuous Rating – Higher Temperature for Shorter Periods

**StretchSleeve™ High Temperature, Heat & Flame Resistant Super Stretch**

**Expandable Sleeve:**

**Silicone Rubber Coated Expandable Fiberglass Sleeve with UL/CSA rating & NEMA Grade A**



This specially designed sleeve is recommended for sleeving applications, which require a snug fit over irregular shapes.

This sleeve proves a “heat shrink” like fit while still providing flexibility, abrasion resistance, moisture resistance, uv, ozone and chemical resistance.

This sleeve can expand to twice its relaxed diameter.

Electrically rated to +200°C, but can provide higher temperature performance if the electrical properties are not required.

Provides dielectric grade A, NEMA TF-1, Type 5; Mil-I-3190/6 (Grade A).

VW-1 flame retardant

### StretchSleeve™ High Temperature, Heat & Flame Resistant Expandable Silicone Rubber Coated Fiberglass Sleeve

Part Number	Size		I.D. in inches		Spool Size feet	Price per Spool
	AWG	Range	Relaxed	Expanded		
S-FS-HiElas-13-X	#13	#13 - #7	0.076	0.144	250	\$ 69.53
S-FS-HiElas-9-X	#9	#9 - #3	0.118	0.229	250	call
S-FS-HiElas-6-X	#6	#6 - #1	0.166	0.289	250	call
S-FS-HiElas-3-X	#3	#3 - .437"	0.234	0.437	250	call
S-FS-HiElas-0-X	#0	#0 - .625"	0.330	0.625	100	call
S-FS-HiElas-375-X	.375"	.375" - .750"	0.375	0.750	100	\$ 286.95
S-FS-HiElas-500-X	.500"	.500" - 1.00"	0.500	1.000	100	\$ 439.71
S-FS-HiElas-625-X	.625"	.625" - 1.25"	0.625	1.250	100	\$ 536.31

For X: use "WH" for White. Use "BK" for Black

**High Elasticity Firesleeve (Continued)**

**392°F / 200°C: Continuous Rating – Higher Temperature for Shorter Periods**

**StretchSleeve™ High Temperature, Heat & Flame Resistant Super Stretch Expandable Sleeve:**

**Silicone Rubber Coated Expandable Fiberglass Sleeve with UL/CSA rating & NEMA Grade A**



Coating: 30 durometer, shore A; tensile strength >1000 psi; Elongation > 600%; Tear strength 150 ppi; Available in Black or White.

**Electrical**

Dielectric Strength:

after 48/23/50, Grade A  
after 96/23/96, Grade A

NEMA TF-1  
NEMA TF-1

8000V min avg., 6000v min individual  
80% of Original Value

Hydrostatic Stability after 336 hrs  
@ 70°C over Constant Water Reflex

MIL-I-3190/9

Passes 7660V min avg with no  
disintegration, reversion or cracks  
(spec 5000V)

Flame Resistance

NEMA TF-1  
VW-1  
MIL-I-3190/9, Method A  
MIL-I-3190/9

Passes  
Passes  
Passes  
No cracks or ruptures, 6000V min avg  
breakdown strength

Pushback

## PTFE Soft Coated Fiberglass Braided Sleeve

550°F / 287°C: Continuous Rating – Higher Temperature for Shorter Periods

DeltaGlass™ High Temperature, Heat & Chemical Resistant Sleeve



- Available in 1/16" – 1.59mm & 1/8" - 3.18mm wall thickness
- Soft PTFE coating

Excellent resistance to almost all solvents, caustics and acids.

The base yarn is rated to 1200°F / 648°C.

The PTFE coating melting point is 620°F / 327°C.

550°F / 287°C continuous rating, high insulation value & excellent personnel protection

This sleeve is an excellent choice for applications requiring a PTFE seal at high temperatures, as the sleeve's fiberglass base material supports the PTFE and reduces creep of the PTFE at high temperatures.

Although this is a sleeve, it can be used flattened as a tape



**PTFE Soft Coated Fiberglass Braided Sleeve (Continued)**  
**550°F / 287°C: Continuous Rating – Higher Temperature for Shorter Periods**  
**DeltaGlass™ High Temperature, Heat & Chemical Resistant Sleeve**



PTFE Soft Coated Fiberglass Braided Sleeve High-Temperature, Heat & Chemical Resistance						
Part Number	Size in / mm / -dash#			Feet per Spool Thin Wall / Thick Wall	Price / foot Thin wall	Price / foot Thick wall
S-FG-PTFE-M006-04-X	.250	6	-04	1400 / 700	\$ 1.68	\$ 3.28
S-FG-PTFE-M010-06-X	.375	10	-06	1400 / 600	\$ 1.88	\$ 3.64
S-FG-PTFE-M013-08-X	.500	13	-08	1000 / 330	\$ 2.44	\$ 6.16
S-FG-PTFE-M016-10-X	.625	16	-10	900 / 315	\$ 3.28	\$ 6.60
S-FG-PTFE-M019-12-X	.750	19	-12	750 / 300	\$ 3.88	\$ 6.64
S-FG-PTFE-M022-14-X	.875	22	-14	650 / 300	\$ 4.40	\$ 6.72
S-FG-PTFE-M025-16-X	1.000	25	-16	500 / 290	\$ 5.32	\$ 7.28
S-FG-PTFE-M032-20-X	1.250	32	-20	450 / 280	\$ 6.24	\$ 7.92
S-FG-PTFE-M038-24-X	1.500	38	-24	350 / 225	\$ 7.68	\$ 9.36
S-FG-PTFE-M041-26-X	1.625	41	-26	300 / 208	\$ 7.72	\$ 9.43
S-FG-PTFE-M044-28-X	1.750	44	-28	300 / 208	\$ 8.12	\$ 9.92
S-FG-PTFE-M051-32-X	2.000	51	-32	250 / 190	\$ 9.98	\$ 13.40
S-FG-PTFE-M057-36-X	2.250	57	-36	250 / 190	\$ 10.31	\$ 14.11
S-FG-PTFE-M064-40-X	2.500	64	-40	225 / 180	\$ 11.88	\$ 14.52
S-FG-PTFE-M070-44-X	2.750	70	-44	225 / 180	\$ 12.03	\$ 15.48
S-FG-PTFE-M076-48-X	3.000	76	-48	200 / 175	\$ 13.12	\$ 18.16
S-FG-PTFE-M083-52-X	3.250	83	-52	200 / 175	\$ 13.43	\$ 18.58
S-FG-PTFE-M089-56-X	3.500	89	-56	190 / 170	\$ 14.24	\$ 19.56
S-FG-PTFE-M095-60-X	3.750	95	-60	190 / 170	\$ 15.09	\$ 20.16
S-FG-PTFE-M102-64-X	4.000	102	-64	175 / 140	\$ 17.28	\$ 22.12
S-FG-PTFE-M114-72-X	4.500	114	-72	175 / 140	\$ 20.66	\$ 29.23
S-FG-PTFE-M127-80-X	5.000	127	-80	120 / 100	\$ 24.76	\$ 37.68

**For the “X” value, use “1” to specify Thin Wall; use “2” to specify Thick Wall**

**Thin Wall = 1/16” / 1.59mm • Thick Wall = 1/8” / 3.18mm / This Product is Available By-The-Foot**

The PTFE is applied to the sleeve through a proprietary sinterization process. The result is a PTFE coating on the sleeve which is soft, robust and flexible; however, it can be abrasively removed from the sleeve with aggressive fingernail scraping, resulting in a thinner and thinner layer of PTFE remaining with each pass. The PTFE also causes the yarns to be sealed and the small gaps between the yarns filled, resulting in an almost air-tight / liquid-tight sleeve wall.

## Fiberglass Fabric with PTFE Resin Coating Sleeve with VELCRO® Brand Hook & Loop Closure

550°F / 287°C: Continuous Rating – Higher Temperature for Shorter Periods

Scuff-Sleeve™ VC



- Specialty protection for hoses, wire and cables.
- Sleeve with Velcro for easy retrofit.
- Sleeve is made from fiberglass base fabric impregnated with a PTFE resin coating. Excellent chemical resistance. Temperature range - 60°F to +550°F. Excellent UV protection. Not for use near open flame or welding.
- Used for food processing robot cables, lines and hoses.
- Washdown resistant
- Removeable for machine cleaning

**Fiberglass Fabric with PTFE Resin Coating Sleeve with VELCRO® Brand Closure (Continued)**  
**550°F / 287°C: Continuous Rating – Higher Temperature for Shorter Periods**  
**Scuff-Sleeve™ VC**



Sold in 50 foot increments up to 150 feet continuous rolls. Available in standard sizes; larger or custom sizes can be easily fabricated if required. Helps to organize and bundle hoses and cables.

<b>Scuff-Sleeve™ VC: PTFE Impregnated Fiberglass Fabric Specialty Protection Sleeve with VELCRO® Brand Hook &amp; Loop Closure</b>				
<b>Part Number</b>	<b>Size</b>			<b>Price per Foot</b>
	<b>inch</b>	<b>mm</b>	<b>-dash</b>	<b>FG/PTFE resin</b>
S-FG-PTFE-VCL-M025-16 *	1.00	25	-16	\$ 12.03
S-FG-PTFE-VCL-M051-32	2.00	51	-32	\$ 15.60
S-FG-PTFE-VCL-M064-40	2.50	64	-40	\$ 16.76
S-FG-PTFE-VCL-M070-44	2.75	70	-44	\$ 18.28
S-FG-PTFE-VCL-M076-48	3.00	76	-48	\$ 19.55
S-FG-PTFE-VCL-M083-52	3.25	83	-52	\$ 20.36
S-FG-PTFE-VCL-M089-56	3.50	89	-56	\$ 21.47
S-FG-PTFE-VCL-M102-64	4.00	102	-64	\$ 22.36
S-FG-PTFE-VCL-M127-80	5.00	127	-80	\$ 23.84
S-FG-PTFE-VCL-M152-96	6.00	152	-96	\$ 24.91
S-FG-PTFE-VCL-M178-112	7.00	165	-104	\$ 31.40
S-FG-PTFE-VCL-M203-128	8.00	203	-128	\$ 32.37

**Custom sizes available**

Width of the Velcro is 1.5" except part numbers indicated with (\*) which is .75".

## Kevlar® Braided Aramid Sleeve

**320°F / 160°C: Continuous Rating – Higher Temperature for Shorter Periods**

**FlameShield™ High Temperature, Heat Resistant High Strength & Cut Resistant Expandable Sleeve - Premium Grade**



- Kevlar sleeve is soft, pliable, and highly flexible.
- Halogen & asbestos free.
- Fibers are 20 times stronger than steel for the same diameter..
- Highly cut resistant.
- Braid angle allows this sleeve to expand slightly to accommodate irregular surfaces and turns, splices and in-line connectors. Expansion does cause surface coverage to reduce.
- Available in natural (yellow) color.

**320°F / 160°C maximum continuous rating with high insulation value & excellent personnel protection. Short term exposure to 572°F / 300°C**

**Kevlar® Braided Aramid Sleeve - (Continued)**  
**320°F / 160°C: Continuous Rating – Higher Temperature for Shorter Periods**  
**FlameShield™ High Temperature, Heat Resistant High Strength &**  
**Cut Resistant Expandable Sleeve - Premium Grade**



FlameShield™ High Temperature & Heat Resistant Braided Kevlar® Aramid Sleeve - Premium					
Part Number	Nominal ID	Size Range	Spool Length in feet Bulk / Small	Price per Spool Bulk Spool / Small Spool	Price per Foot
S-K-M006-04-X	1/4" / 6 mm	1/8" to 5/16"	500 / 50	\$ 291.25 / \$ 42.37	\$ 1.68
S-K-M013-08-X	1/2" / 13 mm	5/16" to 5/8"	250 / 50	\$ 373.76 / \$ 87.25	\$ 3.48
S-K-M019-12-X	3/4" / 19 mm	9/16" to 1"	250 / 50	\$ 561.24 / \$ 124.75	\$ 4.98
S-K-M025-16-X	1" / 25 mm	3/4" to 1 1/8"	200 / 25	\$ 599.21 / \$ 87.37	\$ 6.98
S-K-M032-20-X	1 1/4" / 32 mm	1" to 1 1/2"	125 / 25	\$ 467.54 / \$ 106.43	\$ 8.51
S-K-M038-24-X	1 1/2" / 38 mm	1 1/4" to 1 3/4"	100 / 25	\$ 516.75 / \$ 141.70	\$ 11.23
S-K-M051-32-X	2" / 51 mm	1 1/2" to 2 1/8"	100 / 25	\$ 801.37 / \$ 212.75	\$ 17.02
S-K-M064-40	2 1/2" / 64mm	NA	100	\$ 1144.80 / NA	NA
S-K-M076-48	3" / 76mm	NA	100	\$ 1136.70 / NA	NA
S-K-M089-56	3 1/2" / 89mm	NA	100	\$ 1595.70 / NA	NA
S-K-M102-64	4" / 102mm	NA	100	\$ 1849.50 / NA	NA

For the "X" value: "F" for By-The-Foot followed by length in feet (example: F66 = 66 feet)  
 use "B" for Bulk Spool size, use "S" for Small Spool size

This Product is available in spools and for some sizes also By-The-Foot



Kevlar products are difficult to cut due to their strength. Regular or heavy duty scissors can sometimes cut these materials, but often fail quickly as the Kevlar quickly dulls the cutting edge.

Kevlar Shears are specifically designed to cut Kevlar, and feature a serrated blade (or dual serrated blades) so that the fibers don't slip while cutting, holding the fiber in position and allowing for a greater shear force to be applied by the opposing blade.

These shears are Extra Heavy Duty, and can be used for other materials such as cutting steel wires and steel tie wraps. Part number TL-S-KEV-HD. Priced from \$52.00 to \$79.00 depending on blade length.

Kevlar® is a registered trademark of E. I. Du Pont de Nemours and Company



**Kevlar® Braided Aramid Sleeve - Heavy Wall**  
**320°F / 160°C: Continuous Rating – Higher Temperature for Shorter Periods**  
**FlameShield™ High Temperature, Heat Resistant, High Strength & Cut Resistant**  
**Expandable Sleeve - Premium Grade – Heavy Wall Thickness**

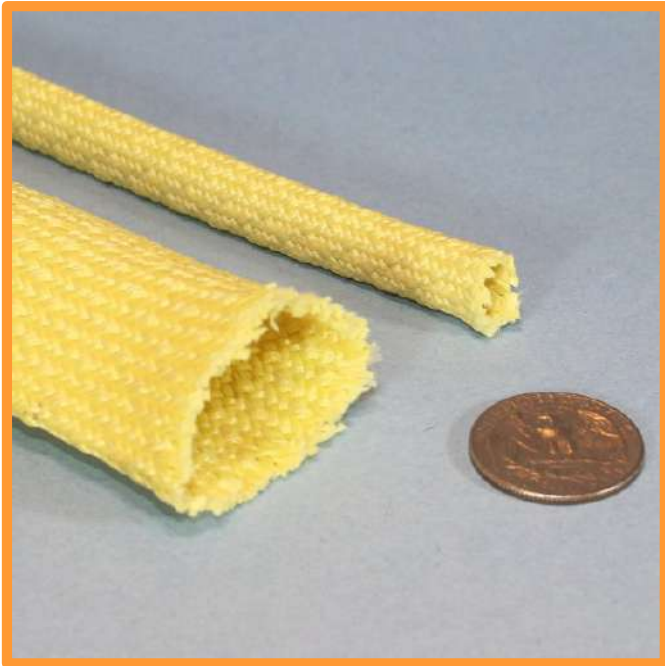

- Soft and pliable, highly flexible.
- Halogen & asbestos free.
- 20 times stronger than steel.
- Highly cut resistant.
- Braid angle allows this sleeve to expand to accommodate irregular surfaces and turns, splices and in-line connectors.
- Available in natural (yellow) color.
- .056" / 1.42 mm wall thickness.

**320°F / 160°C maximum continuous rating with high insulation value & excellent personnel protection. Short term exposure to 572°F / 300°C**

FlameShield™ High Temperature & Heat Resistant Braided Kevlar® Aramid Sleeve – Premium Heavy Wall					
Part Number	Nominal ID	Size Range	Spool Length		Price per Spool Bulk Spool / Small Spool
			In feet Bulk / Small		
S-K-HD-M006-04-X	1/4" / 6 mm	1/4" to 3/8"	500 / 50		\$ 1397.82 / \$ 152.50
S-K-HD-M013-08-X	1/2" / 13 mm	1/2" to 1"	250 / 50		\$ 1250.05 / \$ 262.50
S-K-HD-M025-16-X	1" / 25 mm	1" to 1 3/4"	200 / 25		\$ 1424.67 / \$ 190.63
S-K-HD-M032-20-X	1 1/4" / 32 mm	1 1/4" to 2"	125 / 25		\$ 1103.72 / \$ 232.50

For the "X" value: use "F" for By-The-Foot followed by length in feet (example: F66 = 66 feet)  
 use "B" for Bulk Spool size, use "S" for Small Spool size

**This Product is available in By-The-Foot lengths and spools**



Kevlar products are difficult to cut due to their strength. Regular or heavy duty scissors can sometimes cut these materials, but often fail quickly as the Kevlar quickly dulls the cutting edge.

Kevlar Shears are specifically designed to cut Kevlar, and feature a serrated blade (or dual serrated blades) so that the fibers don't slip while cutting, holding the fiber in position and allowing for a greater shear force to be applied by the opposing blade.

These shears are Extra Heavy Duty, and can be used for other materials such as cutting steel wires and steel tie wraps. Part number TL-S-KEV-HD. Priced from \$52.00 to \$79.00 depending on blade length.

Kevlar® is a registered trademark of E. I. Du Pont de Nemours and Company

**Kevlar® Braided Aramid Sleeve – Colored - Medium Wall Thickness**  
**320°F / 160°C: Continuous Rating – Higher Temperature for Shorter Periods**  
**FlameShield™ High Temperature, Heat Resistant High Strength &**  
**Cut Resistant Expandable Sleeve - Premium Grade**



- Kevlar® sleeve is soft and pliable, highly flexible.
- Halogen & asbestos free.
- Fibers are 20 times stronger than steel for the same diameter. Highly cut resistant.
- Braid angle allows this sleeve to expand/contract slightly to accommodate irregular surfaces and turns, splices and in-line connectors. Expansion does cause surface coverage to reduce slightly.
- Available in 5 colors (plus natural yellow). The colored sleeve is made by adding a saturant which make the sleeve stiffer than non colored sleeve.
- .045" / 1.14 mm wall thickness.
- This product is made from genuine Kevlar® aramid yarns. Kevlar® is a registered trademark of DuPont.

**320°F / 160°C maximum continuous rating with high insulation value  
& excellent personnel protection. Short term exposure to 572°F / 300°C**

**Kevlar® Braided Aramid Sleeve – Colored - Medium Wall Thickness (Continued)**  
**320°F / 160°C: Continuous Rating – Higher Temperature for Shorter Periods**  
**FlameShield™ High Temperature, Heat Resistant High Strength &**  
**Cut Resistant Expandable Sleeve - Premium Grade**



<b>FlameShield™ High Temperature &amp; Heat Resistant Braided Kevlar® Aramid Colored Sleeve – Premium Grade</b>		
<b>Part Number</b>	<b>Nominal ID</b>	<b>Price 50' spool / 100' spool</b>
S-K-C-0.25-M006-04-X-Y	1/4" / 6 mm	\$ 102.45 / \$ 186.30
S-K-C-0.50-M013-08-X-Y	1/2" / 13 mm	\$ 194.54 / \$ 353.70
S-K-C-0.75-M019-12-X-Y	3/4" / 19 mm	\$ 213.40 / \$ 388.00
S-K-C-1.00-M025-16-X-Y	1" / 25 mm	\$ 297.00 / \$ 540.00
S-K-C-1.25-M032-20-X-Y	1 1/4" / 32 mm	\$ 346.01 / \$ 629.10
S-K-C-1.50-M038-24-X-Y	1 1/2" / 38 mm	\$ 397.98 / \$ 723.60
S-K-C-1.75-M044-28-X-Y	1 3/4" / 44 mm	\$ 482.63 / \$ 877.50
S-K-C-2.00-M051-32-X-Y	2" / 51 mm	\$ 556.88 / \$ 1012.50
S-K-C-2.50-M064-40-X-Y	2 1/2" / 64 mm	\$ 629.64 / \$ 1144.80
S-K-C-3.00-M076-48-X-Y	3" / 76 mm	\$ 781.11 / \$ 1420.20
S-K-C-3.50-M089-56-X-Y	3 1/2" / 89 mm	\$ 1097.42 / \$ 1995.30
S-K-C-4.00-M102-64-X-Y	4" / 102 mm	\$ 1271.16 / \$ 2311.20

For the "X" value use OG - Orange, BK - Black, BL - Blue, RD - Red and GN - Green

For the "X" value use "50" for 50 feet and use "100" for 100 feet

**This Product is available only in 50' and 100' Lengths  
(shorter lengths of some sizes may be available - please inquire)**

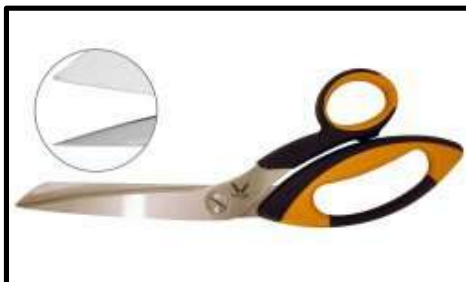

Kevlar products are difficult to cut due to their strength. Regular or heavy duty scissors can sometimes cut these materials, but often fail quickly as the Kevlar quickly dulls the cutting edge.

Kevlar Shears are specifically designed to cut Kevlar, and feature a serrated blade (or dual serrated blades) so that the fibers don't slip while cutting, holding the fiber in position and allowing for a greater shear force to be applied by the opposing blade.

These shears are Extra Heavy Duty, and can be used for other materials such as cutting steel wires and steel tie wraps. Part number TL-S-KEV-HD. Priced from \$52.00 to \$79.00 depending on blade length.

Kevlar® is a registered trademark of E. I. Du Pont de Nemours and Company

**Silicone Foam Sleeve High Temperature, Heat Resistant**  
460°F / 237°C: Continuous Rating – Higher Temperature for Shorter Periods  
High Insulation Value for Hoses Tubing & Pipes



Silicone Closed Cell Foam sleeve is designed as a high thermal insulation sleeve for hoses and pipes to preserve the temperature of flowing liquids and gases.

May be covered with other sleeving such as nylon for abrasion protection.

Available in Oxide-red and Grey

<b>FlameShield™ Silicone Closed Cell Sponge Sleeve High Temperature &amp; Heat Resistant – High Thermal Insulation Value</b>			
<b>Part Number</b>	<b>Nominal ID</b>	<b>Wall Thickness</b>	<b>Price per Spool 100ft / 25ft</b>
S-SR-SF-M013-08-X-Y	1/2"	1/2	\$ call
S-SR-SF-M019-12-X-Y	3/4"	1/2	\$ call
S-SR-SF-M025-16-X-Y	1"	1/2	\$ call
S-SR-SF-M032-20-X-Y	1 1/4"	3/4	\$ call
S-SR-SF-M038-24-X-Y	1 1/2"	3/4	\$ call
S-SR-SF-M044-28-X-Y	1 3/4"	3/4	\$ call

For the "X" value, use "100" for 100 foot spool, use "50" for 50 foot spool, use "25" for 25 foot spool

For the "Y" value, use "OR" oxide-red, use "GR" for grey

This Product is NOT Available By-The-Foot – Spools Only

## Closed Cell Foam Insulation Sleeve

220°F / 104°C: Continuous Rating – Higher Temperature for Shorter Periods  
High Insulation Value for Hoses Tubing & Pipes

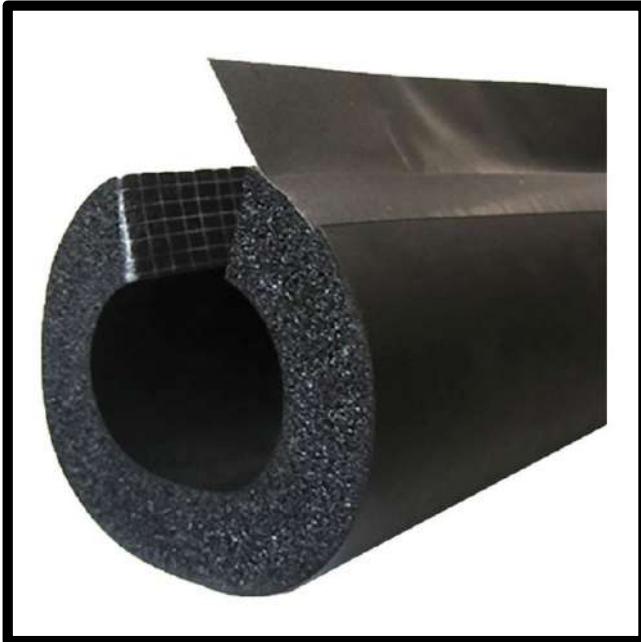

- R-3 insulation value.
- Condensation prevention solution for water and refrigeration lines.
- Split sleeve with seam adhesive plus adhesive flap.
- 6 foot / 1.82 metre lengths.
- Mold and Mildew resistant.
- Compatible with heating cables and tapes for freeze protection.
- 0.5" / 13mm wall thickness.
- Highly flexible and conformable.
- ID of sleeve is designed to accommodate pipe plus heating cable/tape when used in size combination recommended in table below.

FlameShield™ Closed Cell Foam Sleeve High Thermal Insulation Value - Pipe Heat Retention & Freeze Protection			
Part Number	Nominal Pipe OD	Actual Sleeve ID	Price per 6' / 1.82 m stick
S-INSULPIPE-0875	½" to 5/8"	7/8"	\$ 34.00
S-INSULPIPE-1125	¾" to 7/8"	1 1/8"	\$ 38.00
S-INSULPIPE-1375	1"	1 3/8"	\$ 44.00
S-INSULPIPE-1625	1 1/8"	1 5/8"	\$ 48.00
S-INSULPIPE-2000	1 3/8"	2"	\$ 54.00
S-INSULPIPE-2125	1 5/8"	2 1/8"	\$ 58.00
S-INSULPIPE-2375	2"	2 3/8"	\$ 78.00
S-INSULPIPE-2625	2 1/8"	2 5/8"	\$ 88.00
S-INSULPIPE-2875	2 3/8"	2 7/8"	\$ 96.00
S-INSULPIPE-3125	2 5/8"	3 1/8"	\$ 102.00
S-INSULPIPE-3500	2 7/8"	3 1/2"	\$ 108.00
S-INSULPIPE-3625	3 1/8"	3 5/8"	\$ 110.00
S-INSULPIPE-4125	3 1/2"	4 1/8"	\$ 134.00
S-INSULPIPE-4500	4"	4 1/2"	\$ 138.00



## Nomex® Braided Sleeve

450°F / 232°C: Continuous Rating – Higher Temperature for Shorter Periods

FlameShield™ High Temperature, Heat & Flame Resistant Expandable Sleeve – Premium Grade



- Genuine Dupont Nomex®
- Soft and pliable.
- Halogen & asbestos free.
- 90,000 psi tensile strength.
- Cuts easily to length with scissors. Braid angle allows this sleeve to expand slightly to accommodate irregular surfaces and turns, splices and in-line connectors.
- Available in natural and green color.
- .016" wall thickness.
- 662°F / 350°C melting/deterioration temperature.

450°F / 232°C continuous rating, high insulation value & excellent personnel protection

FlameShield™ Braided Nomex® Sleeve High Temperature & Heat Resistant – Premium Grade			
Part Number	Nominal ID	Size Range	Price per Spool 100ft / 25ft
S-NMX-0.125-M003-02-X-Y	1/8"	1/16" to 1/4"	\$ 44.66 / \$ 23.53
S-NMX-0.250-M006-04-X-Y	1/4"	1/8" to 5/16"	\$ 180.25 / \$ 57.76
S-NMX-0.312-M008-05-X-Y	5/16"	7/32" to 7/16"	\$ 209.75 / \$ 64.90
S-NMX-0.375-M010-06-X-Y	3/8"	1/4" to 1/2"	\$ 240.00 / \$ 72.51
S-NMX-0.500-M013-08-X-Y	1/2"	5/16" to 5/8"	\$ 326.06 / \$ 94.05
S-NMX-0.625-M016-10-X-Y	5/8"	7/16" to 7/8"	\$ 415.33 / \$ 116.24
S-NMX-0.750-M019-12-X-Y	3/4"	9/16" to 1"	\$ 512.06 / \$ 140.52
S-NMX-1.000-M025-16-X-Y	1"	3/4" to 1 1/8"	\$ 865.75 / \$ 228.97
S-NMX-1.250-M032-20-X-Y	1 1/4"	1" to 1 1/2"	\$ 1250.25 / \$ 325.43
S-NMX-1.500-M038-24-X-Y	1 1/2"	1 1/4" to 1 3/4"	\$ 1442.75 / \$ 373.60
S-NMX-1.750-M044-28-X-Y	1 3/4"	1 1/2" to 2"	\$ 1707.22 / \$ 439.67

For the "X" value, use "100" for 100 foot spool, use "25" for 25 foot spool

For the "Y" value, use "NT" natural color, use "GN" for green color

Please call for additional discount pricing when ordering multiple spools.

**This Product is NOT Available By-The-Foot – Spools Only**

## Nomex® Split Sleeve Wrap

450°F / 232°C: Continuous Rating – Higher Temperature for Shorter Periods

FlameShield™ High Temperature, Heat & Flame Resistant Expandable Sleeve – Premium Grade



- Genuine Dupont Nomex® with a pre-stressed PET filament which provides the natural closed wrap form
- Soft and pliable.
- Fire retardant
- Halogen & asbestos free.
- Cuts easily to length with scissors.
- Green color only.
- .027" wall thickness.
- 392°F / 200°C operating temperature.
- 662°F / 350°C melting/deterioration temperature.
- Includes a tracer line that shows the maximum operating diameter so the sleeve is not overfilled

450°F / 232°C continuous rating, high insulation value & excellent personnel protection

FlameShield™ Nomex® Split Sleeve Wrap High Temperature & Heat Resistant – Premium Grade			
Part Number	Nominal ID	Quantity per Box Bulk / Shop / Mini in feet	Price Bulk / Shop / Mini
S-NMX-SP-0.1875-M0047-03-X	3/16"	1200 / 600 / 200	\$ 2380.00 / \$ 1190.40 / \$ 430.10
S-NMX-SP-0.312-M0079-05-X	5/16"	650 / 325 / 125	\$ 1799.22 / \$ 899.60 / \$ 354.00
S-NMX-SP-0.500-M013-08-X	1/2"	300 / 150 / 75	\$ 1171.20 / \$ 585.60 / \$ 300.80
S-NMX-SP-0.625-M016-10-X	5/8"	250 / 125 / 75	\$ 1264.31 / \$ 632.81 / \$ 387.21
S-NMX-SP-0.750-M019-12-X	3/4"	150 / 100 / 50	\$ 903.71 / \$ 601.31 / \$ 308.21
S-NMX-SP-1.000-M025-16-X	1"	100 / 75 / 50	\$ 766.40 / \$ 574.80 / \$ 391.20
S-NMX-SP-1.250-M032-20-X	1 1/4"	100 / 50 / 25	\$ 1384.00 / \$ 692.00 / \$ 354.00
S-NMX-SP-1.500-M038-24-X	1 1/2"	50 / 25 / NA	\$ 838.40 / \$ 419.20 / NA

For the "X" value, use "B" for Bulk Box or "S" for Shop Box or "M" for Mini Box

Please call for additional discount pricing when ordering multiple spools.

**This Product is NOT Available By-The-Foot**

## Fiberglass Knitted Sleeve: Premium Grade

### 1200°F / 648°C: Continuous Rating – Higher Temperature for Shorter Periods

#### DeltaGlass™ Very High Temperature & Heat Resistant Knitted Sleeve for Wire, Cable, Hose & Pipe / Tube protection and Personnel Burn Protection



This Knitted fiberglass sleeve is fabricated from high quality type E fiberglass that will not burn and will withstand continuous exposure to temperatures of 1200°F / 648°C.

This material resists most acids and alkalis and is unaffected by most bleaches and solvents. It is highly flexible and conformable.

The base fiber is manufactured to the specifications of ASTM D-578, ASTM committee D13, and subcommittee D13.18.

Knitted or Braided Fiberglass Sleeve is typically used to protect pipes, hoses, cables and wires from high temperatures up to 1200°F / 648°C continuous use.

1200°F / 648°C continuous rating, high insulation value & excellent personnel burn protection.

Knitted sleeve has an advantage over braided sleeve, as it is dimensionally stable and only minimally expandable compared to braided sleeve – it conforms well to the object over which it is placed without clamping to hold it onto the object.

This sleeve is commonly used to protect wire, cables and hoses from heat exposure. The construction of the sleeve provides a high bulk, ensuring a high insulation value. It can also be used in multiple layers to increase the total insulation value. Conversely, this sleeve can protect personnel from contact burns due to hot process hoses, tubing or lines.

The total sleeve thickness necessary to drop the surface temperature to the 140°F hot surface incidental contact temperature (OSHA generally accepted value) varies with the temperature of the hose or tube, the fluid flow rate, and ambient temperature; but as a general rule, a pipe or tube at 1000°F will require a 1" thickness of fiberglass insulation.

### DeltaGlass™ Very High Temperature & Heat Resistant Knitted Fiberglass Sleeve – Premium Grade

ID Size inch / mm / dash#			Part Number	Price per Foot / 100 ft length	ID Size inch / mm / dash#			Part Number	Price per Foot / 100 ft length
1/2"	13	-08	S-FG-KNIT-M013-08	\$ 2.66 / \$ 133.00	2 1/4"	57	-36	S-FG-KNIT-M057-36	\$ 10.20 / \$ 510.00
5/8"	16	-10	S-FG-KNIT-M016-10	\$ 2.94 / \$ 147.00	2 1/2"	64	-40	S-FG-KNIT-M064-40	\$ 13.20 / \$ 660.00
3/4"	19	-12	S-FG-KNIT-M019-12	\$ 3.34 / \$ 167.00	2 3/4"	70	-44	S-FG-KNIT-M070-44	\$ 16.86 / \$ 843.00
7/8"	22	-14	S-FG-KNIT-M022-14	\$ 3.94 / \$ 197.00	3"	76	-48	S-FG-KNIT-M076-48	\$ 19.00 / \$ 950.00
1"	25	-16	S-FG-KNIT-M025-16	\$ 4.54 / \$ 227.00	3 1/4"	83	-52	S-FG-KNIT-M083-52	\$ 20.34 / \$ 1017.00
1 1/4"	32	-20	S-FG-KNIT-M032-20	\$ 5.40 / \$ 270.00	3 1/2"	89	-56	S-FG-KNIT-M089-56	\$ 21.86 / \$ 1093.00
1 3/8"	35	-22	S-FG-KNIT-M035-22	\$ 5.54 / \$ 277.00	3 3/4"	95	-60	S-FG-KNIT-M095-60	\$ 22.66 / \$ 1133.00
1 1/2"	38	-24	S-FG-KNIT-M038-24	\$ 5.66 / \$ 283.00	4"	102	-64	S-FG-KNIT-M102-64	\$ 22.86 / \$ 1143.00
1 3/4"	44	-28	S-FG-KNIT-M044-28	\$ 7.34 / \$ 367.00	4 1/2"	114	-72	S-FG-KNIT-M114-72	\$ 26.26 / \$ 1313.00
1 7/8"	48	-30	S-FG-KNIT-M048-30	\$ 7.94 / \$ 397.00	5"	127	-80	S-FG-KNIT-M127-80	\$ 30.20 / \$ 1510.00
2"	51	-32	S-FG-KNIT-M051-32	\$ 8.54 / \$ 427.00	6"	152	-96	S-FG-KNIT-M152-96	\$ 36.20 / \$ 1810.00

Minimum order is 25 feet

DeltaGlass™ Knitted or Braided Fiberglass Sleeving is typically used to protect hoses, cables and wires from high temperatures up to 1200°F / 648°C continuous use.

Fiber Type:	E Glass	Specific Gravity:	2.54-2.69
Breaking Tenacity:	1.71 gf/TEX. Std. 1.71 gf/TEX Wet	Tensile Strength:	450,000-500,000 psi.
Breaking Elongation:	4.81% Std. 4.81% Wet	Elastic Recovery:	100%
Average Stiffness:	2824.3 cn/TEX		

Effect of Heat: Will not burn; Retains 75% tensile at 343°C; Softens at 732-877°C; Melts at 1121-1182°C  
 Effect of Acids and Alkalis; Resistance to acids is fair. Good resistance to most alkalis.  
 Effect of Bleaches and Solvents: Unaffected

**Fiberglass Braided Sleeve: Premium Grade**  
**1200°F / 648°C: Continuous Rating – Higher Temperature for Shorter Periods**  
**DeltaGlass™ Very High Temperature Heat Resistant Braided Sleeve for Wire, Cable, Hose & Pipe / Tube protection and Personnel Burn Protection**



This Braided fiberglass sleeve is fabricated from high quality type E fiberglass that will not burn and will withstand continuous exposure to temperatures of 1200°F / 648°C.

This material resists most acids and alkalis and is unaffected by most bleaches and solvents. It is highly flexible and conformable.

The base fiber is manufactured to the specifications of ASTM D-578, ASTM committee D13, and subcommittee D13.18.

1200°F / 648°C continuous rating, high insulation value & excellent personnel protection

Both a Heat Treated and Heat Treated with Acrylic Saturant version of this product is available – please enquire

Braided sleeve has the ability to expand and contract a nominal amount, if expanded then the coverage of the braid is lower than if the sleeve is contracted.

This sleeve is commonly used to protect wire, cables and hoses from heat exposure. The construction of the sleeve provides a high bulk, ensuring a high insulation value. It can also be used in multiple layers to increase the total insulation value. Conversely, this sleeve can protect personnel from contact burns due to hot process hoses, tubing or lines.

The total sleeve thickness necessary to drop the surface temperature to the 140°F hot surface incidental contact temperature (OSHA generally accepted value) varies with the temperature of the hose or tube, the fluid flow rate, and ambient temperature; but as a general guide, a pipe or tube at 1000°F will require a 1" thickness of fiberglass insulation.

**DeltaGlass™ Very High Temperature & Heat Resistant Braided Fiberglass Sleeve - Premium Grade**

ID Size inch / mm / dash#			Part Number	Price per Foot / 100 ft spool	ID Size inch / mm / dash#			Part Number	Price per Foot / 100 ft spool
3/8	10	-06	S-FG-BRAID-M010-06	\$ 4.34 / \$ 217.00	1 7/8"	48	-30	S-FG-BRAID-M048-30	\$ 14.88 / \$ 744.00
1/2"	13	-08	S-FG-BRAID-M013-08	\$ 4.64 / \$ 232.00	2"	51	-32	S-FG-BRAID-M051-32	\$ 16.66 / \$ 833.00
5/8"	16	-10	S-FG-BRAID-M016-10	\$ 4.94 / \$ 247.00	2 1/4"	57	-36	S-FG-BRAID-M057-36	\$ 17.34 / \$ 867.00
3/4"	19	-12	S-FG-BRAID-M019-12	\$ 6.00 / \$ 300.00	2 1/2"	64	-40	S-FG-BRAID-M064-40	\$ 18.08 / \$ 904.00
7/8"	22	-14	S-FG-BRAID-M022-14	\$ 6.62 / \$ 331.00	2 3/4"	70	-44	S-FG-BRAID-M070-44	\$ 19.34 / \$ 967.00
1"	25	-16	S-FG-BRAID-M025-16	\$ 7.34 / \$ 367.00	3"	76	-48	S-FG-BRAID-M076-48	\$ 21.00 / \$ 1050.00
1 1/4"	32	-20	S-FG-BRAID-M032-20	\$ 8.66 / \$ 433.00	3 1/4"	83	-52	S-FG-BRAID-M083-52	\$ 23.00 / \$ 1150.00
1 3/8"	35	-22	S-FG-BRAID-M035-22	\$ 9.66 / \$ 483.00	3 1/2"	89	-56	S-FG-BRAID-M089-56	\$ 24.10 / \$ 1205.00
1 1/2"	38	-24	S-FG-BRAID-M038-24	\$ 10.66 / \$ 533.00	3 3/4"	95	-60	S-FG-BRAID-M095-60	\$ 24.86 / \$ 1243.00
1 3/4"	44	-28	S-FG-BRAID-M044-28	\$ 12.66 / \$ 633.00	4"	102	-64	S-FG-BRAID-M102-64	\$ 25.66 / \$ 1283.00

Minimum order is \$200.00. By-The-Foot sleeve may be mixed sizes to achieve minimum order.

DeltaGlass™ Knitted or Braided Fiberglass sleeve is typically used to protect hoses, cables and wires from high temperatures up to 1200°F / 648°C continuous use.

Fiber Type:	E Glass	Specific Gravity:	2.54-2.69
Breaking Tenacity:	1.71 gf/TEX. Std. 1.71 gf/TEX Wet	Tensile Strength:	450,000-500,000 psi.
Breaking Elongation:	4.81% Std. 4.81% Wet	Elastic Recovery:	100%
Average Stiffness:	2824.3 cn/TEX		

Effect of Heat: Will not burn; Retains 75% tensile at 343°C; Softens at 732-877°C; Melts at 1121-1182°C  
Effect of Acids and Alkalis: Resistance to acids is fair. Good resistance to most alkalis.  
Effect of Bleaches and Solvents: Unaffected



**Fiberglass Braided Sleeve: Industrial Grade**  
**1200°F / 648°C: Continuous Rating – Higher Temperature for Shorter Periods**  
**DeltaGlass™ Very High Temperature & Heat Resistant**



- DeltaGlass™ Braided Industrial sleeve
- Available in Thin Wall (1/16") and Thick Wall (1/8").

This braided sleeve is fabricated from high quality type E fiberglass that will not burn and will withstand continuous exposure to temperatures of 1200°F / 648°C.

This material resists most acids and alkalis and is unaffected by most bleaches and solvents. It is highly flexible and conformable. The base fiber is manufactured to the specifications of ASTM D-578, ASTM committee D13, and subcommittee D13.18.

A Heat Treated version of this product is available – please enquire

1200°F / 648°C continuous rating, high insulation value & excellent personnel protection

DeltaGlass™ Very High Temperature & Heat Resistant Fiberglass Braided Sleeve - Industrial Grade							
Part Number	Size inch / mm / -dash			Thin Wall		Thick Wall	
				Feet / Metres per spool	Price per Foot / Metre	Feet / Metres per spool	Price per Foot / Metre
S-FG-BI-M006-04-X	.250	6	-4	1400 / 426	\$ 0.56 / \$ 1.84	700 / 213	\$ 1.08 / \$ 3.54
S-FG-BI-M010-06-X	.375	10	-6	1400 / 426	\$ 0.76 / \$ 2.49	600 / 182	\$ 1.20 / \$ 3.94
S-FG-BI-M013-08-X	.500	13	-8	1000 / 304	\$ 0.92 / \$ 3.02	330 / 100	\$ 2.00 / \$ 6.56
S-FG-BI-M016-10-X	.625	16	-10	900 / 274	\$ 0.96 / \$ 3.15	315 / 96	\$ 2.16 / \$ 7.09
S-FG-BI-M019-12-X	.750	19	-12	750 / 228	\$ 1.01 / \$ 3.31	300 / 91	\$ 2.18 / \$ 7.15
S-FG-BI-M022-14-X	.875	22	-14	650 / 198	\$ 1.12 / \$ 3.67	300 / 91	\$ 2.20 / \$ 7.22
S-FG-BI-M025-16-X	1.000	25	-16	500 / 152	\$ 1.52 / \$ 4.99	290 / 88	\$ 2.40 / \$ 7.87
S-FG-BI-M032-20-X	1.250	32	-20	450 / 137	\$ 1.80 / \$ 5.90	280 / 85	\$ 2.60 / \$ 8.53
S-FG-BI-M038-24-X	1.500	38	-24	350 / 106	\$ 2.36 / \$ 7.74	225 / 68	\$ 3.04 / \$ 9.97
S-FG-BI-M044-28-X	1.750	44	-28	300 / 91	\$ 2.52 / \$ 8.27	208 / 63	\$ 3.24 / \$ 10.63
S-FG-BI-M051-32-X	2.000	51	-32	250 / 76	\$ 2.64 / \$ 8.66	190 / 57	\$ 4.36 / \$ 14.30
S-FG-BI-M064-40-X	2.500	64	-40	225 / 68	\$ 2.96 / \$ 9.71	180 / 54	\$ 4.76 / \$ 15.61
S-FG-BI-M076-48-X	3.000	76	-48	200 / 60	\$ 3.20 / \$ 10.50	175 / 53	\$ 5.92 / \$ 19.42
S-FG-BI-M089-56-X	3.500	89	-56	190 / 57	\$ 3.56 / \$ 11.68	170 / 51	\$ 6.40 / \$ 20.99
S-FG-BI-M102-64-X	4.000	102	-64	175 / 53	\$ 5.88 / \$ 19.29	140 / 42	\$ 7.20 / \$ 23.62
S-FG-BI-M127-80-X	5.000	127	-80	120 / 36	\$ 6.16 / \$ 20.21	100 / 30	\$ 12.28 / \$ 40.28

**For the "X" value in the part number:  
use "1" to specify Thin Wall; use "2" to specify Thick Wall**

**Thin Wall = 1/16" / 1.59mm • Thick Wall = 1/8" / 3.18mm**

**This Product is Available By-The-Foot**



**Fiberglass Braided Heat Treated Sleeve: Premium Grade**  
**1200°F / 648°C: Continuous Rating – Higher Temperature for Shorter Periods**  
**DeltaGlass™ Very High Temperature & Heat Resistant – Passes UL VW-1 Flame Test**



This Braided fiberglass sleeve is fabricated from high quality type E fiberglass that will not burn and will withstand continuous exposure to temperatures of 1200°F / 648°C.

Heat Treating removes organics and impurities from the sleeve, and makes the product dimensionally stable to the high-end of its continuous exposure temperature (providing minimal shrinkage). The sleeve is exceptionally smooth and has extremely few loose filament ends protruding from the braid – making it extremely clean to use in a variety of applications including aerospace wiring protection and bundling and clean room applications.

This material resists most acids and alkalis and is unaffected by most bleaches and solvents. It is highly flexible and conformable.

The braiding is fine and dense, providing excellent protective coverage. Common applications for heat treated sleeve is for the protection of wiring, cables and hoses in consumer, industrial and commercial appliances and equipment such as ovens, kilns, toasters and heaters. The base fiber is manufactured to the specifications of ASTM D-578, ASTM committee D13, and subcommittee D13.18.

**1200°F / 648°C continuous rating, high insulation value & excellent personnel protection**

<b>Very High Temperature &amp; Heat Resistant                      Fiberglass Braided Heat Treated Sleeve – Premium Grade                      UL 1441 (VW-1) / Dielectric C-3 / UL Thermal Class S &amp; C</b>			
Part Number	ID Size in / mm / dash #	Feet / Metres per Spool	Price Spool / Foot
S-FG-BHT-M006-04	0.250 / 6 / -4	500 / 152	\$ 815.00 / \$4.08
S-FG-BHT-M010-06	0.375 / 10 / -6	500 / 152	\$ 915.00 / \$4.58
S-FG-BHT-M013-08	0.500 / 13 / -8	400 / 121	\$ 997.00 / \$6.25
S-FG-BHT-M016-10	0.625 / 16 / -10	500 / 152	\$ 1,565.00 / \$7.83
S-FG-BHT-M019-12	0.750 / 19 / -12	400 / 121	\$ 1,332.00 / \$8.33
S-FG-BHT-M025-16	1.000 / 25 / -16	250 / 76	\$ 1,092.50 / \$10.93
S-FG-BHT-M038-24	1.500 / 38 / -24	200 / 60	\$ 1,500.00 / \$18.75

Please call for additional discount pricing when ordering more than 5 spools.

**This Product is available By-The-Foot and by Spool Length**

**Braided Fiberglass Sleeve – Texturized - High Bulk**  
**1200°F / 648°C: Continuous Rating – Higher Temperature for Shorter Periods**  
**MaxSleeve™ Temperature & Heat Resistant Fiberglass Braided High Bulk Texturized Sleeve:**  
**Premium Grade**



- DeltaGlass™ Braided High Bulk Texturized Premium Sleeve.
- Highest Insulation Value Sleeve Available.
- Available in Thin Wall (1/16”) and Thick Wall (1/8”).
- Texturization provides high bulk & high thermal insulation value

This braided sleeve is fabricated from high quality type E fiberglass that will not burn and will withstand continuous exposure to temperatures of 1200°F / 648°C.

This material resists most acids and alkalis and is unaffected by most bleaches and solvents. It is highly flexible and conformable. The base fiber is manufactured to the specifications of ASTM D-578, ASTM committee D13, and subcommittee D13.18.

Available Plain and Vermiculite Coated.

1200°F / 648°C continuous rating, high insulation value & excellent personnel protection

<b>DeltaGlass™ High Bulk Texturized Braided Fiberglass Sleeve</b>							
<b>Premium Grade</b>							
Part Number	Size inch / mm / -dash			Thin Wall		Thick Wall	
				Feet / Metres per spool	Price per Spool	Feet / Metres per spool	Price per Spool
S-FG-TEX-M010-06-X	.375	10	-6	N/A	N/A	250 / 76	\$ 717.50
S-FG-TEX-M013-08-X	.500	13	-8	500 / 152	\$ 740.00	250 / 76	\$ 787.50
S-FG-TEX-M016-10-X	.625	16	-10	N/A	N/A	100 / 30	\$ 495.00
S-FG-TEX-M019-12-X	.750	19	-12	250 / 76	\$ 587.50	100 / 30	\$ 540.00
S-FG-TEX-M025-16-X	1.000	25	-16	250 / 76	\$ 675.00	100 / 30	\$ 585.00
S-FG-TEX-M032-20-X	1.250	32	-20	N/A	N/A	100 / 30	\$ 630.00
S-FG-TEX-M038-24-X	1.500	38	-24	250 / 76	\$ 787.50	100 / 30	\$ 675.00
S-FG-TEX-M051-32-X	2.000	51	-32	N/A	N/A	100 / 30	\$ 743.00

**For the “X” value in the part number:  
use “1” to specify Thin Wall; use “2” to specify Thick Wall**

**Thin Wall = 1/16” / 1.59mm • Thick Wall = 1/8” / 3.18mm**

## Fiberglass Braided Anti-Fray Expandable Heat Treated & Saturated Sleeve - Premium Grade

1200°F / 648°C: Continuous Rating – Higher Temperature for Shorter Periods

DeltaGlass™ Very High Temperature & Heat Resistant Expandable Sleeve



- This Braided fiberglass sleeve is fabricated from high quality type E fiberglass that will not burn and will withstand continuous exposure to temperatures of 1200°F / 648°C. The sleeve is heat treated before being saturated.
- This material resists most acids and alkalis and is unaffected by most bleaches and solvents. It is highly flexible and conformable.
- The base fiber is manufactured to the specifications of ASTM D-578, ASTM committee D13, and subcommittee D13.18.
- The braid angle of this sleeve allows for the sleeve to easily adjust to a range of sizes around its nominal ID – so it can accommodate passing over splices and in-line connectors.
- The saturant provides reduced fray when cutting this sleeve, as can be seen by the clean ends of the sleeve in this photo. As well, the sleeve becomes stiffer (notice the sleeve remains tubular and does not collapse under its own weight as it would unsaturated). The sleeve remains highly conformable and flexible even with the saturant; it flexes, bends with the same radius as unsaturated sleeve and curves easily and will not prevent or restrict wiring and cable routing.
- Available with colored saturant. The saturant will smoke off at temperatures above 425F.

**Fiberglass Braided Anti-Fray Expandable Heat Treated & Saturated Sleeve - Premium Grade (Continued)**

**1200°F / 648°C continuous rating, high insulation value & excellent personnel protection**

<b>Very High Temperature &amp; Heat Resistant Braided Heat Treated Fiberglass with Acrylic Saturated Sleeve Premium Grade</b>				
<b>Part Number</b>		<b>Size Range</b>	<b>Feet / Metres per Spool</b>	<b>Price per Spool</b>
S-FG-B-HT-SAT-M006/010-04/06	¼" / 6mm	1/4" to 3/8"	600 / 182	\$ 690.00
S-FG-B-HT-SAT-M010/013-06/08	3/8" / 10mm	3/8" to 1/2"	400 / 121	\$ 748.00
S-FG-B-HT-SAT-M013/019-08/12	½" / 13mm	1/2" to 3/4"	300 / 91	\$ 891.00
S-FG-B-HT-SAT-M016/025-10/16	5/8" / 16mm	5/8" to 1"	250 / 76	\$ 995.00
S-FG-B-HT-SAT-M019/032-12/20	¾" / 19mm	3/4" to 1 1/4"	250 / 76	\$ 1,332.50
S-FG-B-HT-SAT-M025/044-16/28	1" / 25mm	1" to 1 3/4"	200 / 60	\$ 1,584.00
S-FG-B-HT-SAT-M038/057-24/36	1 ½" / 38mm	1 1/2" to 2 1/4"	150 / 45	\$ 1,828.50
S-FG-B-HT-SAT-M064/102-40/64	2 ½" / 64mm	2 1/2" to 4"	75 / 22	\$ 1,464.75

The addition of an acrylic saturant adds rigidity and abrasive resistance to the sleeve, reducing the likelihood of end fray and results in a sleeve that is easy to apply over long lengths of hose or cable.

The base material temperature rating is 1200°F / 648°C, however the saturant will smoke off at temperatures above 425F / 218°C.

The large braid angle allows for significant expansion of the sleeve resulting in ease of installation, for example, in situations where a hose may have an in-line coupling or adapter to a larger size hose; or similarly where cables may have a splice.

Please contact us for colored versions.

**This Product is NOT Available By-The-Foot – Full Spool Only**



## Fiberglass Braided Sleeve - AWG Wire Gauge Sized – Small Diameter E Glass

**1200°F / 648°C: Continuous Rating – Higher Temperature for Shorter Periods**  
**DeltaGlass™ Very High Temperature & Heat Resistant Insulation with 1375 volts**  
**space factor rating and NEMA TF-2 Section 6.3 flame resistance**

**E-Glass Precision Small Diameter / Heavy Wall:**  
**Heat Treated or Heat Treated with Binders**



Above Left: Standard Wall Thickness  
Above Right: 1/32" Heavy Wall Thickness



Standard Wall Thickness  
Heat Treated with Binders

**Plain & Heat Treated sleeve is 1200°F / 648°C continuous, 1742°F / 950°C intermittent.**

**Sleeve with binders is rated to 600°F / 316°C continuous, 1140°F / 616°C intermittent.**

This is a high-strength, high-temperature fiberglass sleeve produced from E-Glass. Available heat treated; with Acrylic resin or Oleoresinous binder. Both heat treated and with binders reduces fray and makes cutting easier.

The braiding is tight and dense, providing excellent coverage over small wires, cables, hoses, tubes and pipes.

This product conforms to NEMA TF-2 and is made from fibers conforming to MIL-Y-1140 (latest version), Class C, Form 1 (continuous filament yarns). Meets VW-1 flammability requirements.

### E-Glass Properties:

Specific Gravity g/cm <sup>3</sup> :	2.55 - 2.58
Elongation at break, %:	4.5 - 4.9
Tensile strength, psi @22°C:	500,000 - 550,000
Water absorbency @22°C, 65% R.H.:	None
Space Factor Insulation, volts:	1100 (Std Wall) 1500 (HD wall)
Volume Resistivity at 22°C and 500 volts DC, ohm-cm:	10 <sup>15</sup> – 10 <sup>16</sup>
Dielectric Constant at 22°C, 60 Hz:	6.5 – 6.8
Dissipation Factor at 22°C, 1 MHz:	0.001 – 0.005

### Common Properties:

Good resistance to most acids and alkalies  
Unaffected by bleaches and solvents  
Excellent resistance to sunlight and aging. Not attacked by Mildew.  
Conforms to NEMA TF-2. Fibers conform to MIL-R-60346. Type IV, Class 1.

**This product is made to order: Delivery is approximately 5 to 15 business days.**



**Very High Temperature & Heat Resistant Fiberglass Braided Sleeve**  
**E-Glass Precision Small Diameter / Standard Wall Thickness**  
**Heat Treated or Heat Treated with Binders**  
**with NEMA classification & Meets MIL-Y-1140 Class C Form 1**  
**Meets UL 1441 VW-1 Flame Resistance – Will Not Burn**

Part Number	Nominal Size AWG / inch / mm / -dash				Price per Spool		Feet per Coil
					Heat Treated	Heat Treated with Binders	
S-FG-E-AWG24-X	24	0.022	0.56	NA	\$ 117.00	\$ 146.25	500'
S-FG-E-AWG22-X	22	0.027	0.69	NA	\$ 120.25	\$ 149.50	500'
S-FG-E-AWG20-X	20	0.034	0.86	NA	\$ 123.63	\$ 152.75	500'
S-FG-E-AWG19-X	19	0.038	0.96	NA	\$ 126.75	\$ 156.00	500'
S-FG-E-AWG18-X	18	0.042	1.07	NA	\$ 130.00	\$ 159.25	500'
S-FG-E-AWG17-X	17	0.047	1.19	NA	\$ 133.25	\$ 162.50	500'
S-FG-E-AWG16-X	16	0.053	1.35	NA	\$ 136.50	\$ 169.00	500'
S-FG-E-AWG15-X	15	0.059	1.50	NA	\$ 143.12	\$ 175.50	500'
S-FG-E-AWG14-X	14	0.066	1.68	-01	\$ 146.25	\$ 182.00	500'
S-FG-E-AWG13-X	13	0.076	1.93	NA	\$ 73.13	\$ 92.62	250'
S-FG-E-AWG12-X	12	0.085	2.16	NA	\$ 74.75	\$ 97.50	250'
S-FG-E-AWG11-X	11	0.095	2.41	NA	\$ 81.25	\$ 107.25	250'
S-FG-E-AWG10-X	10	0.106	2.69	NA	\$ 82.87	\$ 108.87	250'
S-FG-E-AWG9-X	9	0.118	3.10	NA	\$ 89.37	\$ 113.75	250'
S-FG-E-AWG8-X	8	0.133	3.38	-02	\$ 95.87	\$ 126.75	250'
S-FG-E-AWG7-X	7	0.148	3.76	NA	\$ 104.00	\$ 134.87	250'
S-FG-E-AWG6-X	6	0.166	4.22	NA	\$ 68.25	\$ 86.77	150'
S-FG-E-AWG5-X	5	0.186	4.72	-03	\$ 74.10	\$ 94.57	150'
S-FG-E-AWG4-X	4	0.208	5.28	NA	\$ 79.95	\$ 105.30	150'
S-FG-E-AWG3-X	3	0.234	5.94	NA	\$ 92.62	\$ 115.05	150'
S-FG-E-AWG2-X	2	0.263	6.68	-04	\$ 102.37	\$ 133.57	150'
S-FG-E-AWG1-X	1	0.294	7.47	NA	\$ 117.97	\$ 151.12	150'
S-FG-E-05-X	5/16	0.313	7.95	-05	\$ 135.52	\$ 177.45	150'
S-FG-E-AWG0-X	0	0.330	8.38	NA	\$ 163.80	\$ 190.12	150'
S-FG-E-06-X	3/8	0.375	9.52	-06	\$ 193.05	\$ 250.57	150'
S-FG-E-07-X	7/16	0.438	11.12	-07	\$ 145.60	\$ 183.95	100'
S-FG-E-08-X	1/2	0.500	12.70	-08	\$ 155.35	\$ 195.65	100'
S-FG-E-10-X	5/8	0.625	15.87	-10	\$ 167.70	\$ 211.90	100'
S-FG-E-12-X	3/4	0.750	19.05	-12	\$ 206.70	\$ 259.35	100'
S-FG-E-14-X	7/8	0.875	22.22	-14	\$ 228.15	\$ 287.95	100'
S-FG-E-16-X	1	1.000	25.40	-16	\$ 277.55	\$ 349.05	100'

For the "X" value in the part number:

use "HT" to specify Heat Treated

use "HTA" to specify Heat Treated plus Acrylic Resin Binder,

use "HTAF" to specify Heat Treated plus Acrylic Resin Flexible Binder

- Resin treated available in white, red, green, brown, yellow, black, blue.

use "HTO" to specify Heat Treated with Oleoresinous Varnish Binder

Plain & Heat Treated sleeve is 1200°F / 648°C continuous, 1742°F / 950°C intermittent

Sleeve with binders is rated to 600°F / 316°C continuous, 1140°F / 616°C intermittent

See Size Table at the end of this catalog section for dimensional specifications

This Product must be purchased in full coils except as indicated below:

S-FG-E-AWG11-X is available by the foot; \$4.29 per foot

This product is not stock, it is made to order: Delivery is approximately 15 business days.

## Fiberglass Braided Sleeve - AWG Wire Gauge Sized – Small Diameter S Glass

**1200°F / 648°C: Continuous Rating – Higher Temperature for Shorter Periods**  
*DeltaGlass™ Very High Temperature & Heat Resistant Insulation with 1375 volts space factor rating and NEMA TF-2 Section 6.3 flame resistance*

**S-Glass Precision Small Diameter / NEMA Wall Thickness:**  
**Plain or Heat Treated, Heat Treated with Binders**



S-Fiberglass Sleeve: Plain & Heat Treated



Heat Treated Sleeve with Binders

**Plain & heat treated sleeve is 1200°F / 648°C continuous, 1742°F / 950°C intermittent.**

**Sleeve with binders is rated to 600°F / 316°C continuous, 1140°F / 616°C intermittent.**

This is a high-strength, high-temperature fiberglass sleeve produced from S-Glass. S-Glass, which in addition to enhanced dielectric and mechanical properties over e-glass, provides thermal protection beyond the limits of conventional E-glass fibers. S-Glass is free of boron and will not decompose to form gaseous products with nuclear radiation exposure. Also available heat treated; with Acrylic resin or Oleoresinous binder. Both heat treated and with binders reduces fray and makes cutting easier.

The braiding is tight and dense, providing excellent coverage over small wires, cables, hoses, tubes and pipes.

### S-Glass Properties:

Specific Gravity g/cm <sup>3</sup> :	2.48 – 2.49
Elongation at break, %:	5.3 – 5.7
Tensile strength, psi @22°C:	650,000 – 700,000
Water absorbency @22°C, 65% R.H.:	None
Space Factor Insulation, volts:	1375

### Common Properties:

Good resistance to most acids and alkalis  
Unaffected by bleaches and solvents  
Excellent resistance to sunlight and aging. Not attacked by Mildew.  
Conforms to NEMA TF-2. Fibers conform to MIL-R-60346. Type IV, Class 1.

**This product is made to order: Delivery is approximately 5 to 15 business days.**

**Very High Temperature & Heat Resistant Fiberglass Braided Sleeve  
S-Glass Precision Small Diameter / NEMA Wall Thickness: Plain or Heat Treated  
with 1375 volts space factor insulation and NEMA TF-2 section 6.3 flame rating**

Part Number	Nominal Size AWG / inch / mm / -dash				Price per Spool			Feet per Spool
					Plain	Heat Treated	HT w/binder	
S-FG-S-AWG24-X	24	0.022	0.56	NA	\$ 192.38	\$ 233.46	\$ 255.51	500'
S-FG-S-AWG22-X	22	0.027	0.69	NA	\$ 207.41	\$ 243.48	\$ 270.54	500'
S-FG-S-AWG20-X	20	0.034	0.86	NA	\$ 212.42	\$ 253.50	\$ 275.55	500'
S-FG-S-AWG19-X	19	0.038	0.96	NA	\$ 222.44	\$ 258.51	\$ 290.58	500'
S-FG-S-AWG18-X	18	0.042	1.07	NA	\$ 237.47	\$ 278.55	\$ 305.61	500'
S-FG-S-AWG17-X	17	0.047	1.19	NA	\$ 252.50	\$ 298.59	\$ 335.67	500'
S-FG-S-AWG16-X	16	0.053	1.35	NA	\$ 287.57	\$ 338.67	\$ 375.75	500'
S-FG-S-AWG15-X	15	0.059	1.50	NA	\$ 322.64	\$ 383.76	\$ 415.83	500'
S-FG-S-AWG14-X	14	0.066	1.68	-01	\$ 357.71	\$ 418.83	\$ 460.92	500'
S-FG-S-AWG13-X	13	0.076	1.93	NA	\$ 199.79	\$ 233.92	\$ 257.03	250'
S-FG-S-AWG12-X	12	0.085	2.16	NA	\$ 214.85	\$ 255.01	\$ 275.10	250'
S-FG-S-AWG11-X	11	0.095	2.41	NA	\$ 232.92	\$ 275.59	\$ 300.20	250'
S-FG-S-AWG10-X	10	0.106	2.69	NA	\$ 244.97	\$ 290.55	\$ 320.28	250'
S-FG-S-AWG9-X	9	0.118	3.10	NA	\$ 269.07	\$ 318.26	\$ 350.40	250'
S-FG-S-AWG8-X	8	0.133	3.38	-02	\$ 292.16	\$ 348.38	\$ 377.51	250'
S-FG-S-AWG7-X	7	0.148	3.76	NA	\$ 312.24	\$ 374.48	\$ 410.64	250'
S-FG-S-AWG6-X	6	0.166	4.22	NA	\$ 203.34	\$ 238.57	\$ 264.76	150'
S-FG-S-AWG5-X	5	0.186	4.72	-03	\$ 221.46	\$ 264.74	\$ 289.93	150'
S-FG-S-AWG4-X	4	0.208	5.28	NA	\$ 243.61	\$ 289.91	\$ 316.11	150'
S-FG-S-AWG3-X	3	0.234	5.94	NA	\$ 276.83	\$ 327.16	\$ 358.39	150'
S-FG-S-AWG2-X	2	0.263	6.68	-04	\$ 311.06	\$ 367.43	\$ 405.70	150'
S-FG-S-AWG1-X	1	0.294	7.47	NA	\$ 350.32	\$ 414.74	\$ 459.06	150'
S-FG-S-05-X	5/16	0.313	7.95	-05	\$ 380.52	\$ 444.94	\$ 493.29	150'
S-FG-S-AWG0-X	0	0.330	8.38	NA	\$ 407.70	\$ 478.17	\$ 526.51	150'
S-FG-S-06-X	3/8	0.375	9.52	-06	\$ 767.10	\$ 897.96	\$ 993.62	150'
S-FG-S-07-X	7/16	0.438	11.12	-07	\$ 618.21	\$ 737.34	\$ 815.21	100'
S-FG-S-08-X	1/2	0.500	12.70	-08	\$ 786.35	\$ 919.33	\$ 1017.55	100'
S-FG-S-10-X	5/8	0.625	15.87	-10	\$ 942.74	\$ 1104.21	\$ 1221.71	100'
S-FG-S-12-X	3/4	0.750	19.05	-12	\$ 1192.11	\$ 1239.54	\$ 1546.92	100'
S-FG-S-14-X	7/8	0.875	22.22	-14	\$ 1298.63	\$ 1519.79	\$ 1683.68	100'
S-FG-S-16-X	1	1.000	25.40	-16	\$ 1530.84	\$ 1791.54	\$ 1984.17	100'

For the "X" value in the part number:

use "P" to specify Plain

use "HT" to specify Heat Treated

use "HTA" to specify Heat Treated plus Acrylic Resin Binder

use "HTO" to specify Heat Treated with Oleoresinous Varnish Binder

- Resin treated available in white, red, green, brown, yellow, black, blue.

- See table at end of section for dimensional specifications for this product.
- Plain & Heat Treated sleeve is 1200°F / 648°C continuous, 1742°F / 950°C intermittent.
- Sleeve with binders is rated to 600°F / 316°C continuous, 1140°F / 616°C intermittent
- This product is available in full coils except as listed below.

**By The Foot Pricing:** S-FG-S-AWG16-HT is available at \$3.55 per foot. S-FG-S-AWG10-HT is available at 5.94 per foot

- This product is not stock, it is made to order: Delivery is approximately 10 business days.

## Fiberglass Braided Sleeve - AWG Wire Gauge Sized - E Glass Precision Small Diameter - Thick Wall - Heavy Duty



**1200°F / 648°C: Continuous Rating – Higher Temperature for Shorter Periods**  
**DeltaGlass™ Very High Temperature & Heat Resistant Insulation with 1375 volts**  
**space factor rating and NEMA TF-2 Section 6.3 flame resistance**

**E-Glass Precision Small Diameter / Heavy Wall:**  
**Heat Treated or Heat Treated with Binders**



- Plain sleeve is 1200°F / 648°C continuous, 1742°F / 950°C intermittent.
- Sleeve with binders is rated to 600°F / 316°C continuous, 1140°F / 616°C intermittent.
- This product is available in full spools only.
- Resin treated available in white, red, green, brown, yellow, black, blue.
- This is not a stock item: approximately 10 business days to manufacture to order.

**Very High Temperature & Heat Resistant Fiberglass Braided Sleeve  
E-Glass Precision Small Diameter / Heavy Wall (1/32" - .031" )  
Heat Treated or Heat Treated with Binders  
with NEMA classification & Meets MIL-Y-1140 Class C Form 1  
Meets UL 1441 VW-1 Flame Resistance – Will Not Burn**

Part Number	Nominal Size AWG / inch / mm / -dash				Price per Spool		Feet per Coil
					Heat Treated	Heat Treated with Binders	
S-FG-E-HD-AWG24-X	24	0.022	0.56	NA	\$ 180.00	\$ 225.00	500'
S-FG-E-HD-AWG22-X	22	0.027	0.69	NA	\$ 185.00	\$ 230.00	500'
S-FG-E-HD-AWG20-X	20	0.034	0.86	NA	\$ 195.00	\$ 235.00	500'
S-FG-E-HD-AWG19-X	19	0.038	0.96	NA	\$ 195.00	\$ 240.00	500'
S-FG-E-HD-AWG18-X	18	0.042	1.07	NA	\$ 200.00	\$ 245.00	500'
S-FG-E-HD-AWG17-X	17	0.047	1.19	NA	\$ 205.00	\$ 250.00	500'
S-FG-E-HD-AWG16-X	16	0.053	1.35	NA	\$ 210.00	\$ 260.00	500'
S-FG-E-HD-AWG15-X	15	0.059	1.50	NA	\$ 220.00	\$ 270.00	500'
S-FG-E-HD-AWG14-X	14	0.066	1.68	-01	\$ 225.00	\$ 280.00	500'
S-FG-E-HD-AWG13-X	13	0.076	1.93	NA	\$ 112.50	\$ 142.50	250'
S-FG-E-HD-AWG12-X	12	0.085	2.16	NA	\$ 115.00	\$ 150.00	250'
S-FG-E-HD-AWG11-X	11	0.095	2.41	NA	\$ 125.00	\$ 165.00	250'
S-FG-E-HD-AWG10-X	10	0.106	2.69	NA	\$ 127.50	\$ 167.50	250'
S-FG-E-HD-AWG9-X	9	0.118	3.10	NA	\$ 137.50	\$ 175.00	250'
S-FG-E-HD-AWG8-X	8	0.133	3.38	-02	\$ 147.50	\$ 195.00	250'
S-FG-E-HD-AWG7-X	7	0.148	3.76	NA	\$ 160.00	\$ 207.50	250'
S-FG-E-HD-AWG6-X	6	0.166	4.22	NA	\$ 105.00	\$ 133.50	150'
S-FG-E-HD-AWG5-X	5	0.186	4.72	-03	\$ 114.00	\$ 145.50	150'
S-FG-E-HD-AWG4-X	4	0.208	5.28	NA	\$ 123.00	\$ 162.00	150'
S-FG-E-HD-AWG3-X	3	0.234	5.94	NA	\$ 142.50	\$ 177.00	150'
S-FG-E-HD-AWG2-X	2	0.263	6.68	-04	\$ 157.50	\$ 205.50	150'
S-FG-E-HD-AWG1-X	1	0.294	7.47	NA	\$ 181.50	\$ 232.50	150'
S-FG-E-HD-05-X	5/16	0.313	7.95	-05	\$ 208.50	\$ 273.00	150'
S-FG-E-HD-AWG0-X	0	0.330	8.38	NA	\$ 252.00	\$ 292.50	150'
S-FG-E-HD-06-X	3/8	0.375	9.52	-06	\$ 297.00	\$ 385.50	150'
S-FG-E-HD-07-X	7/16	0.438	11.12	-07	\$ 224.00	\$ 283.00	100'
S-FG-E-HD-08-X	1/2	0.500	12.70	-08	\$ 239.00	\$ 301.00	100'
S-FG-E-HD-10-X	5/8	0.625	15.87	-10	\$ 258.00	\$ 326.00	100'
S-FG-E-HD-12-X	3/4	0.750	19.05	-12	\$ 318.00	\$ 399.00	100'
S-FG-E-HD-14-X	7/8	0.875	22.22	-14	\$ 351.00	\$ 443.00	100'
S-FG-E-HD-16-X	1	1.000	25.40	-16	\$ 427.00	\$ 537.00	100'

For the "X" value in the part number:

use "HT" to specify Heat Treated

use "HTA" to specify Heat Treated plus Acrylic Resin Binder,

use "HTAF" to specify Heat Treated plus Acrylic Resin Flexible Binder

- Resin treated available in white, red, green, brown, yellow, black, blue.

use "HTO" to specify Heat Treated with Oleoresinous Varnish Binder

Plain & heat treated sleeve is 1200°F / 648°C continuous, 1742°F / 950°C intermittent.

Sleeve with binders is rated to 600°F / 316°C continuous, 1140°F / 616°C intermittent

See Size Table at the end of this catalog section for a dimensional specifications

This Product must be purchased in full coils.

This product is not stock, it is made to order: Delivery is approximately 10 business days.



**Fiberglass Braided Sleeve - Special Thin Wall .006" & .008".**  
**Plain, Heat Treated or Heat Treated and with Binders**  
**1200°F / 648°C: Continuous Rating – Higher Temperature for Shorter Periods**  
**DeltaGlass™ Very High Temperature & Heat Resistant**

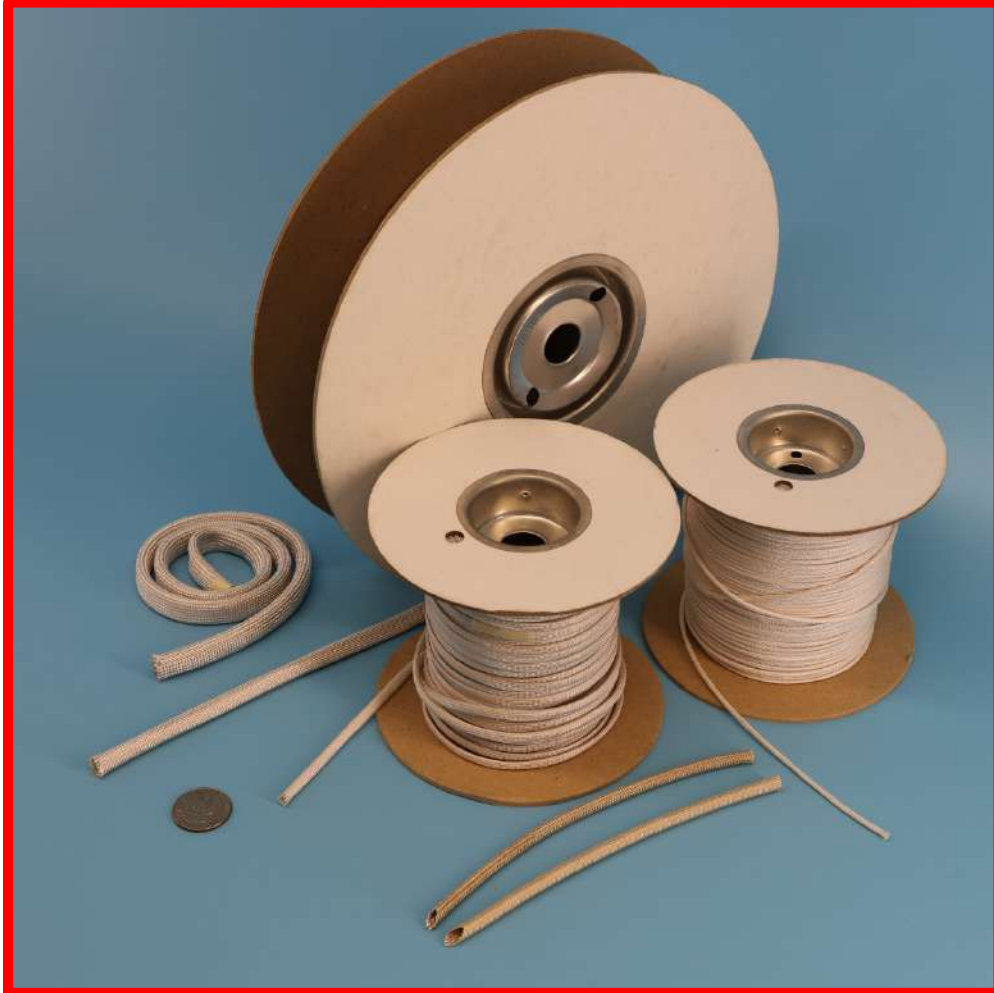

- Plain sleeve is 1200°F / 648°C continuous, 1742°F / 950°C intermittent.
- Sleeve with binders is rated to 600°F / 316°C continuous, 1140°F / 616°C intermittent.
- This product is available in full spools only.
- Resin treated available in white, red, green, brown, yellow, black, blue.
- This is not a stock item: approximately 10 business days to manufacture to order.



**Very High Temperature & Heat Resistant Fiberglass Braided Sleeve  
Special Thin Wall Thickness:**

**Plain available all sizes; or with Resin Binder up to 1/2" / 12.7mm ID**

Part Number	ID Nominal Size inch / mm / -dash			Price per Spool		Feet per Spool
				.006 wall Plain / Heat Treat / w/Resin	.008 wall Plain / Heat Treat / w/Resin	
S-FG-E-TW-M0016-01-X-Y	1/16 / 0.063	1.68	-01	\$ 102.20 / \$ 120.30 / \$ 137.90	\$ 120.30 / \$ 145.44 / \$ 161.90	1200'
S-FG-E-TW-M003-02-X-Y	1/8 / 0.125	3.17	-02	\$ 176.60 / \$ 205.92 / \$ 212.50	\$ 211.00 / \$ 257.52 / \$ 252.40	1200'
S-FG-E-TW-M005-03-X-Y	3/16 / 0.188	4.76	-03	\$ 196.60 / \$ 210.00 / \$ 228.30	\$ 264.30 / \$ 333.12 / \$ 315.50	1200'
S-FG-E-TW-M006-04-X-Y	1/4 / 0.250	6.35	-04	\$ 236.60 / \$ 260.64 / \$ 274.10	\$ 292.10 / \$ 390.72 / \$ 330.60	1200'
S-FG-E-TW-M008-05-X-Y	5/16 / 0.313	7.93	-05	\$ 144.95 / \$ 170.76 / \$ 163.15	\$ 184.75 / \$ 245.40 / \$ 219.15	600'
S-FG-E-TW-M010-06-X-Y	3/8 / 0.375	9.52	-06	\$ 177.25 / \$ 212.40 / \$ 197.55	\$ 223.30 / \$ 288.00 / \$ 277.20	600'
S-FG-E-TW-M011-07-X-Y	7/16 / 0.438	11.11	-07	\$ 191.30 / N/A	\$ 254.00 / N/A	600'
S-FG-E-TW-M013-08-X-Y	1/2 / 0.500	12.7	-08	\$ 210.45 / \$ 277.68 / \$ 234.05	\$ 278.90 / \$ 317.40 / \$ 320.75	600'
Sizes Below Not Available in .006" wall or with Resin Binder						
S-FG-E-TW-M016-10-8	5/8 / 0.625	15.87	-10	N/A	\$ 191.12 / N/A	300'
S-FG-E-TW-M019-12-8	3/4 / 0.750	19.05	-12	N/A	\$ 208.15 / N/A	300'
S-FG-E-TW-M022-14-8	7/8 / 0.875	22.22	-14	N/A	\$ 230.83 / N/A	300'
S-FG-E-TW-M025-16-8	1 / 1.000	25.4	-16	N/A	\$ 277.25 / N/A	300'
S-FG-E-TW-M032-20-8	1 1/4 / 1.250	31.75	-20	N/A	\$ 297.37 / N/A	300'
S-FG-E TW-M038-24-8	1 1/2 / 1.500	38.1	-24	N/A	\$ 326.02 / N/A	300'

**For the "X" value in the part number:** use "8" to specify .008" wall  
use "6" to specify .006" wall

**For the "Y" value in the part number:** use "P" to specify Plain  
Use "HT" ro specify Heat Treated  
use "B" to specify with Binder

**Acrylic Coated Fiberglass Sleeve - Flexible - AWG Small Diameter**  
**311°F / 155°C: High Temperature, Heat & Flame Resistant – UL & CSA Recognized**  
**Available meeting NEMA Grade F-A-1, F-B-1, F-C-1, F-C-2 & F-C-3**



Designed as a primary insulation sleeve for protecting small diameter wire. Recognized by UL and CSA for 155°C, 600 volt service, and complies with VW-1 flammability requirements. Conforms to, and is listed on the QPL for MIL-I-3190/9. Available in 3 grades: NEMA Grade A-1, B-1 and C-1.

Extremely flexible and easily installed. Used in electrical apparatus such as electric motors, transformers, generators, home appliances, lighting fixtures, instrument circuits and controls, switchgear, breaker panels, welding equipment.

The inner braid is very fine and tightly woven, and along with the acrylic coating, this is a tough and flexible sleeve for wire protection.

Available in all standard AWG wire sizes (see end of this section for dimensions and tolerances).

Available in 10 standard colors: Natural, Black, White, Green, Red, Yellow, Blue, Brown, Orange, Gray. Also available in 4 fluorescent colors: Orange, Pink, Green, Yellow.

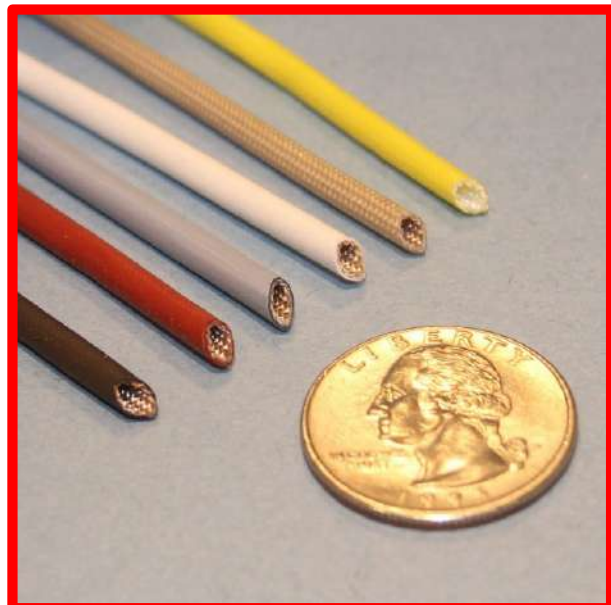



**Acrylic Coated Fiberglass Sleeve - Flexible - AWG Small Diameter**  
**311°F / 155°C: High Temperature, Heat & Flame Resistant – UL & CSA Recognized**  
**Available meeting NEMA Grade F-A-1, F-B-1, F-C-1, F-C-2 & F-C-3**  
**(Continued)**

<u>Property</u>	<u>Procedure</u>	<u>Performance</u>
<b>Physical</b>		
Tensile Strength, Coating	ASTM-D412	850 psi
Ultimate Elongation, Coating	ASTM-D412	150% @ 20°C
Tear Strength, Coating	ASTM-D624	60 psi
Flexibility & Toughness, Coating	UL 1441	Passes Penetration Test
<b>Chemical</b>		
Oil & Solvent* Resistance	MIL-I-3190/9	Passes (good)
Resistance to Acids and Alkalis		Good
Corrosion Resistance	-	Good. Contains no chlorine or other materials contributing to electrolyte formation
Compatibility	UL 1446	Good. Compatible with modified polyester, acrylic, epoxy, phenolic and formvar wire enamels.
<b>Electrical</b>		
Dielectric Strength: after 48/23/50		
Grade A	NEMA TF-1	7000V min avg., 5000v min individual
Grade B	NEMA TF-1	4000v min. Avg., 2500v min. Indiv.
Grade C-1	NEMA TF-1	2500v min. Avg., 1500v min.indiv.
Grade C-2	NEMA TF-1	1500v min. Avg., 800v min.indiv.
Grade C-3	NEMA TF-1	no voltage guarantee
after 96/23/96, Grade A	NEMA TF-1	50% of Original Value
Hydrolytic Stability after 336 hrs @ 70°C over Constant Water Reflex	MIL-I-3190/9	1500 volts min. avg
<b>Thermal</b>		
Thermal Endurance	MIL-I-3190/9 & UL 1441	Class 155°C (F)
Brittleness Temperature	ASTM-D350	-25°C
Flame Resistance	UL 1441	Passes (VW-1), Grade C3 only
	ASTM-D350, Method B	Passes
	NEMA TF-1	Passes
	MIL-I-3190/9, Method B	Passes
Pushback	MIL-I-3190/9	No cracks or ruptures, 6000V min avg breakdown strength
Resistance to potting temperature	MIL-I-3190/3	No blisters, flow or cracks visible after 15 min @ 225C

**This product is not usually stock, it is made to order: Delivery is approximately 10 business days.**



**Acrylic Coated Fiberglass Sleeve - Flexible - AWG Small Diameter**  
**311°F / 155°C: High Temperature, Heat & Flame Resistant – UL & CSA Recognized**  
**Available meeting NEMA Grade F-A-1, F-B-1, F-C-1, F-C-2 & F-C-3**  
**Primary Insulation Coated Fiberglass Sleeve for**  
**Wire Protection, NEMA Grade A-1/B-1/C-1/C-2/C-3 classified**

High Temperature - Small Diameter – Acrylic Coated Fiberglass Sleeve with UL/CSA rating and NEMA Grade F-A-1 / F-B-1 / F-C-1 – F-C-2 – F-C-3 Classification										
Part Number	Nominal ID				Feet per Spool	Price per 100 feet				
	AWG	Inches	mm	-dash		F-A-1	F-B-1	F-C-1	F-C-2	F-C-3
S-FG-ACR-AWG24-X-Y	24	0.022	0.56		500*	\$ 49.60	45.52	39.27	34.60	28.22
S-FG-ACR-AWG22-X-Y	22	0.027	0.69		500*	\$ 50.75	46.87	43.00	35.65	29.87
S-FG-ACR-AWG20-X-Y	20	0.034	0.86		500*	\$ 54.27	47.72	43.35	36.20	30.67
S-FG-ACR-AWG19-X-Y	19	0.038	0.96		500*	\$ 54.51	48.69	44.12	37.35	30.97
S-FG-ACR-AWG18-X-Y	18	0.042	1.07		500*	\$ 54.87	49.60	44.62	38.39	31.37
S-FG-ACR-AWG17-X-Y	17	0.047	1.19		500*	\$ 55.07	50.40	44.97	39.44	31.97
S-FG-ACR-AWG16-X-Y	16	0.053	1.35		500*	\$ 55.92	50.75	45.52	40.00	32.65
S-FG-ACR-AWG15-X-Y	15	0.059	1.50		500*	\$ 57.60	53.67	46.87	40.80	33.45
S-FG-ACR-AWG14-X-Y	14	0.066	1.68	-01	500*	\$ 57.85	54.27	47.10	43.00	34.12
S-FG-ACR-AWG13-X-Y	13	0.076	1.93		250*	\$ 64.12	56.47	50.40	44.12	34.60
S-FG-ACR-AWG12-X-Y	12	0.085	2.16		250*	\$ 65.52	57.85	50.75	45.17	34.80
S-FG-ACR-AWG11-X-Y	11	0.095	2.41		250*	\$ 67.45	62.72	55.07	47.10	38.90
S-FG-ACR-AWG10-X-Y	10	0.106	2.69		250*	\$ 74.50	65.80	57.60	50.40	40.00
S-FG-ACR-AWG9-X-Y	9	0.118	3.10		250*	\$ 77.85	67.70	58.10	53.67	43.00
S-FG-ACR-AWG8-X-Y	8	0.133	3.38	-02	250*	\$ 83.05	74.50	64.42	56.47	45.52
S-FG-ACR-AWG7-X-Y	7	0.148	3.76		250*	\$ 87.20	78.12	67.70	58.10	46.87
S-FG-ACR-AWG6-X-Y	6	0.166	4.22		150*	\$ 95.37	83.55	72.37	64.12	50.40
S-FG-ACR-AWG5-X-Y	5	0.186	4.72	-03	150*	\$ 105.27	92.90	78.37	74.50	58.10
S-FG-ACR-AWG4-X-Y	4	0.208	5.28		150*	\$ 126.60	111.52	93.75	82.80	65.52
S-FG-ACR-AWG3-X-Y	3	0.234	5.94		150*	\$ 141.35	121.97	103.92	91.25	73.17
S-FG-ACR-AWG2-X-Y	2	0.263	6.68	-04	150*	\$ 159.20	138.72	118.37	104.97	83.55
S-FG-ACR-AWG1-X-Y	1	0.294	7.47		150*	\$ 181.72	157.85	132.90	119.47	95.67
S-FG-ACR-05-X-Y	5/16	0.313	7.95	-05	150*	\$ 205.57	179.27	153.22	133.45	106.90
S-FG-ACR-AWG0-X-Y	0	0.330	8.38		150	\$ 213.22	185.52	158.05	139.52	111.82
S-FG-ACR-06-X-Y	3/8	0.375	9.52	-06	150	\$ 296.72	260.32	225.00	191.00	152.15
S-FG-ACR-07-X-Y	7/16	0.438	11.12	-07	100	\$ 392.45	343.90	296.72	254.87	204.17
S-FG-ACR-08-X-Y	1/2	0.500	12.70	-08	100	\$ 455.42	421.12	388.25	331.25	265.02
S-FG-ACR-10-X-Y	5/8	0.625	15.87	-10	100	\$ 560.40	526.95	491.05	417.85	334.60
S-FG-ACR-12-X-Y	3/4	0.750	19.05	-12	100	\$ 674.65	639.87	597.12	545.07	436.82
S-FG-ACR-14-X-Y	7/8	0.875	22.22	-14	100	\$ 824.30	779.02	735.25	665.90	534.05
S-FG-ACR-16-X-Y	1	1.000	25.40	-16	100	\$ 1010.15	955.52	886.20	804.87	645.57
S-FG-ACR-18-X-Y	1 1/8	1.125	28.57	-18	100	\$ 1215.87	1147.92	1066.75	964.55	892.55
S-FG-ACR-20-X-Y	1 1/4	1.250	31.75	-20	100	\$ 1416.45	1334.55	1238.92	1120.25	1036.65
S-FG-ACR-22-X-Y	1 3/8	1.375	34.92	-22	3**	\$ 1559.75	1468.45	1362.20	1232.00	1141.30
S-FG-ACR-23-X-Y	1 7/16	1.437	36.49	-23	3**	\$ 1655.37	1557.55	1443.80	1307.67	1210.05
S-FG-ACR-24-X-Y	1 1/2	1.500	38.10	-24	3**	\$ 1704.97	1602.05	1487.20	1346.32	1244.35
S-FG-ACR-26-X-Y	1 5/8	1.625	41.27	-26	3**	\$ 1756.17	1651.80	1531.52	1386.05	1281.97
S-FG-ACR-28-X-Y	1 3/4	1.750	44.45	-28	3**	\$ 1822.02	1713.22	1281.97	1587.45	1436.45
S-FG-ACR-30-X-Y	1 7/8	1.875	47.62	-30	3**	\$ 2131.42	2004.25	1857.07	1681.65	1557.27
S-FG-ACR-32-X-Y	2	2.000	50.80	-32	3**	\$ 2508.47	2345.92	2176.30	1968.35	1821.67

For 1000 to 4999 feet -10% / For 5000 feet or more -17%

See end of section 1 for a table of pre-coated dimensional specifications for this product

For the "X" value in the part number, specify "S" for standard flexibility or "F" for enhanced flexibility.

For the "Y" value in the part number, specify color

**This product is available in full coils only.**

**This product is not stock, it is made to order: Delivery is approximately 15 business days.**

\* Longer Spool Lengths Available. \*\* Minimum order 30 pieces

**Braided Fiberglass Vehicle Truck Engine Exhaust Pipe Sleeve**  
**1200°F / 648°C: Continuous Rating – Higher Temperature for Shorter Periods**  
**BlackMax™ High Temperature & Heat Resistant**

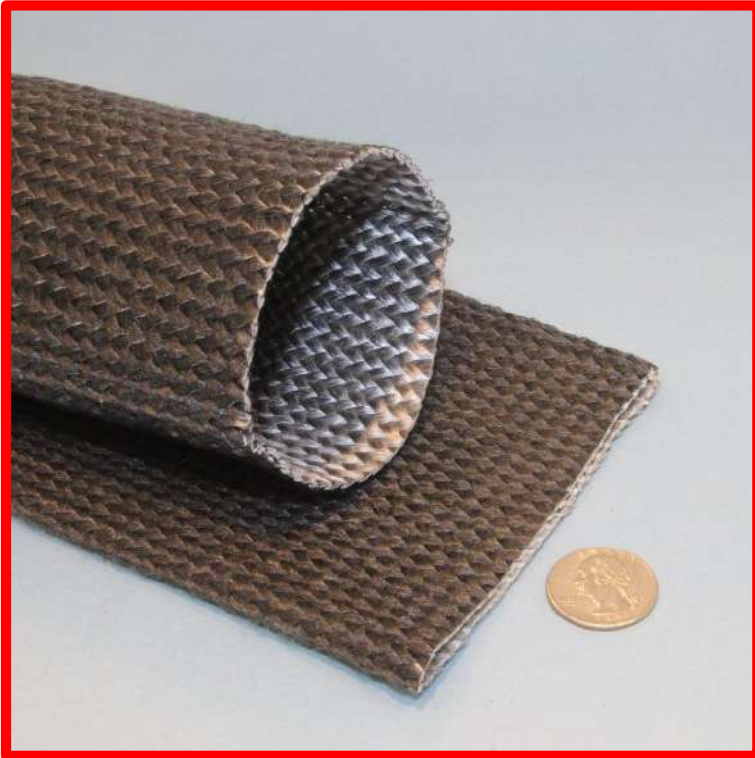

- 1/16" wall thickness
- Acrylic saturant added for enhanced ease of handling and anti-fray

Designed as a protection sleeve for truck & generator engine exhaust piping.

Easy to cut and maintains its end shape for ease of installation. Easily secured with stainless clamps.

Black color hides dirt and grime contamination.

Protects Personnel from incidental contact burns.

Helps prevent fires due to spray from ruptured hydraulic or fuel supply lines contacting hot exhaust metal directly.

**1200°F / 648°C continuous rating, high insulation value & excellent personnel protection**

Very High-Temperature Braided Saturated Sleeve with Acrylic Saturant – Exhaust Pipe Protection Sleeve				
Part Number	Size in / mm / -dash			Price per foot
S-FG-BM-EX-M102-64	4.000	102	-64	\$ 15.36
S-FG-BM-EX-M114-72	4.500	114	-72	\$ 17.65
S-FG-BM-EX-M127-80	5.000	127	-80	\$ 19.64

**This Product is Available By The Foot**



**Braided Fiberglass Sleeve with Graphite Impregnation**  
**1200°F / 648°C: Continuous Rating – Higher Temperature for Shorter Periods**  
**DeltaGlass™: High Temperature & Heat Resistant**



- 1/16" and 1/8" wall thickness
- Graphite Impregnation

Graphite adds lubrication to result in a very slippery sleeve but does not add electrical conductivity.

Resists molten splash and weld splatter as it cannot stick to the graphite.

**1200°F / 648°C continuous rating, high insulation value & excellent personnel protection**

Very High-Temperature Braided Sleeve with Graphite Coating						
Part Number	Size in / mm / -dash			Feet per Spool Thin wall / Thick wall	Price / foot Thin wall Graphite	Price / foot Thick wall Graphite
S-FG-GC-M006-04-X	.250	6	-04	1400 / 700	\$ 2.32	\$ 4.56
S-FG-GC-M010-06-X	.375	10	-06	1400 / 600	\$ 2.60	\$ 5.08
S-FG-GC-M013-08-X	.500	13	-08	1000 / 330	\$ 3.76	\$ 8.60
S-FG-GC-M016-10-X	.625	16	-10	900 / 315	\$ 4.20	\$ 9.20
S-FG-GC-M019-12-X	.750	19	-12	750 / 300	\$ 4.80	\$ 9.36
S-FG-GC-M022-14-X	.875	22	-14	650 / 300	\$ 5.44	\$ 9.44
S-FG-GC-M025-16-X	1.000	25	-16	500 / 290	\$ 6.64	\$ 9.72
S-FG-GC-M032-20-X	1.250	32	-20	450 / 280	\$ 7.76	\$ 11.08
S-FG-GC-M038-24-X	1.500	38	-24	350 / 225	\$ 9.56	\$ 13.08
S-FG-GC-M041-26-X	1.625	41	-26	300 / 208	\$ 9.61	\$ 13.36
S-FG-GC-M044-28-X	1.750	44	-28	300 / 208	\$ 10.12	\$ 13.84
S-FG-GC-M051-32-X	2.000	51	-32	250 / 190	\$ 12.48	\$ 18.68
S-FG-GC-M057-36-X	2.250	57	-36	250 / 190	\$ 12.61	\$ 19.02
S-FG-GC-M064-40-X	2.500	64	-40	225 / 180	\$ 14.84	\$ 20.28
S-FG-GC-M070-44-X	2.750	70	-44	225 / 180	\$ 15.17	\$ 21.55
S-FG-GC-M076-48-X	3.000	76	-48	200 / 175	\$ 15.96	\$ 25.40
S-FG-GC-M083-52-X	3.250	83	-52	200 / 175	\$ 16.67	\$ 26.31
S-FG-GC-M089-56-X	3.500	89	-56	190 / 170	\$ 17.80	\$ 27.44
S-FG-GC-M095-60-X	3.750	95	-60	190 / 170	\$ 18.97	\$ 28.99
S-FG-GC-M102-64-X	4.000	102	-64	175 / 140	\$ 21.36	\$ 31.16
S-FG-GC-M114-72-X	4.500	114	-72	175 / 140	\$ 27.65	\$ 40.73
S-FG-GC-M127-80-X	5.000	127	-80	120 / 100	\$ 35.64	\$ 52.44

For the "X" value, use "A" to specify Thin Wall; use "B" to specify Thick Wall

Thin Wall = 1/16" / 1.59mm • Thick Wall = 1/8" / 3.18mm

This Product is Available By The Foot

## Basalt Fiber Knitted Conformable Engine Exhaust Pipe Insulation Sleeve 1382°F / 750°C: ExhaustSock™

### High Temperature & Heat Resistant Sleeve



- Helps maintain exhaust gas temperatures in order to meet regulatory requirements.
- Knitted design allows for high conformability.
- Can be fabricated with apertures to accommodate brackets and mounting pads.
- Available in pre-cut or continuous lengths.
- Expandable and durable – provides ease of installation.
- Conforms to bends, elbows, flex sections and flanges.
- Suitable for Fixed Generators, Marine Engines and Generators, Automotive, Truck, Bus, Construction and Mining equipment.
- Thermal conductivity: 0.031-0.038 W/mK

#### Parameter

Flammability  
Flammability  
Flammability with Oil Contamination  
Fluid Resistance list below)

#### Test Method

SAE J369 /  
D45133 Type A  
BH 100-524 (ref. SAE J369)  
BH100-003F

#### Result

No ignition  
No ignition  
Self-extinguishing  
No degradation or loss of flexibility

50/50 Antifreeze/Distilled Water ; 5% NaCl; Transmission Fluid; Diesel Fluid LSRD-4; ASTM Reference Fuel C; SAE 5W30; Brake Fluid SAE RM-66; Power Steering Fluid; Windshield Washer Fluid; Salt Spray ASTM G85

#### Thermal Containment Test per BH100-509 on ExhaustSock™ Sleeve 3.5" (89mm) Exhaust Pipe Parameters

Inlet Gas	828°C	Thermal Containment	251°C
Inlet Pipe Surface	534°C	Temperature at 20mm from sleeve (ambient)	121°C
Pipe	552°C	Temperature at 30mm from sleeve (ambient)	100°C
Sleeve	301°C	Temperature at 100mm from sleeve (ambient)	81°C

### Very High-Temperature Knitted Rock Fiber Sleeve For Exhaust Pipe Protection

Part Number	ID Size in / mm / -dash			Feet per Box	Price per Box	Cut Length Price per foot
S-BRF-KNIT-1.00-M025-16	1.00	25	-16	500	\$ 3570.00	\$ 14.28
S-BRF-KNIT-1.50-M038-24	1.50	38	-24	300	\$ 2262.00	\$ 15.08
S-BRF-KNIT-2.00-M051-32	2.00	51	-32	250	\$ 2725.00	\$ 21.80
S-BRF-KNIT-2.50-M064-40	2.50	64	-40	225	\$ 2765.25	\$ 24.58
S-BRF-KNIT-3.00-M076-48	3.00	76	-48	200	\$ 2904.00	\$ 29.04
S-BRF-KNIT-3.50-M089-56	3.50	89	-56	175	\$ 2710.75	\$ 30.98
S-BRF-KNIT-4.00-M102-64	4.00	102	-64	164	\$ 2884.76	\$ 35.18
S-BRF-KNIT-5.00-M127-80	5.00	127	-80	125	\$ 2792.50	\$ 44.68

**MINIMUM ORDER IS \$100.00**

## Braided Carbon Fiber Sleeve

1000°F / 537°C: Continuous Rating – Higher Temperature for Shorter Periods  
High Temperature & Heat Resistant



Available in 0.013", 0.020" and 0.030" wall thickness.

Used to fabricate tubular structures that are lightweight and strong.

The cut ends will fray – standard anti-fray techniques can be used such as metal wire or clamps.

**Braided Carbon Fiber Sleeve (Continued)**  
**1000°F / 537°C: Continuous Rating – Higher Temperature for Shorter Periods**  
*High Temperature & Heat Resistant*

<b>FlameShield™ High Temperature &amp; Heat Resistant Carbon Fiber Sleeve</b>					
Part Number	Nominal ID	Size Range	Spool Length in feet Bulk / Small	Price per Spool Bulk Spool / Small Spool	
<b>Light Wall 0.013" replace "X" in part number with "LW"</b>					
S-CF-M006-04-X	1/4" / 6 mm	1/8" to 5/16"	500 / 100	\$ 635.00 / \$ 168.00	
S-CF-M013-08-X	1/2" / 13 mm	1/4" to 5/8"	250 / 50	\$ 631.25 / \$ 168.00	
S-CF-M019-12-X	3/4" / 19 mm	5/16" to 7/8"	250 / 50	\$ 1,016.25 / \$ 258.00	
S-CF-M025-16-X	1" / 25 mm	3/8" to 1 1/16"	200 / 50	\$ 1,016.50 / \$ 321.00	
S-CF-M032-20-X	1 1/4" / 32 mm	1/2" to 1 1/2"	125 / 25	\$ 763.13 / \$ 198.00	
S-CF-M038-24-X	1 1/2" / 38 mm	5/8" to 1 3/4"	100 / 25	\$ 762.25 / \$ 243.00	
S-CF-M051-32-X	2" / 51 mm	3/4" to 2 3/16"	100 / 25	\$ 915.50 / \$ 291.00	
<b>Medium Wall 0.020" replace "X" in part number with "MW"</b>					
S-CF-M013-08-X	1/2" / 13 mm	1/4" to 5/8"	250 / 50	\$ 739.37 / \$ 192.00	
S-CF-M019-12-X	3/4" / 19 mm	5/16" to 7/8"	250 / 50	\$ 1,110.63 / \$ 282.00	
S-CF-M025-16-X	1" / 25 mm	7/16" to 1 1/16"	200 / 50	\$ 1,184.50 / \$ 369.00	
S-CF-M032-20-X	1 1/4" / 32 mm	9/16" to 1 1/2"	125 / 25	\$ 925.94 / \$ 237.00	
S-CF-M038-24-X	1 1/2" / 38 mm	3/4" to 1 3/4"	100 / 25	\$ 888.25 / \$ 282.00	
S-CF-M051-32-X	2" / 51 mm	7/8" to 2 3/16"	100 / 25	\$ 1,109.25 / \$ 348.00	
S-CF-M064-40-X	2 1/2" / 64 mm	1 1/16" to 3"	100 / 25	\$ 1,332.50 / \$ 414.00	
<b>Heavy Wall 0.030" replace "X" in part number with "HW"</b>					
S-CF-M019-12-X	3/4" / 19 mm	3/8" to 7/8"	250 / 50	\$ 1,362.50 / \$ 342.00	
S-CF-M025-16-X	1" / 25 mm	1/2" to 1 1/16"	200 / 50	\$ 1,450.00 / \$ 450.00	
S-CF-M032-20-X	1 1/4" / 32 mm	11/16" to 1 1/2"	125 / 25	\$ 1,209.38 / \$ 306.00	
S-CF-M038-24-X	1 1/2" / 38 mm	13/16" to 1 3/4"	100 / 25	\$ 1,090.00 / \$ 342.00	
S-CF-M051-32-X	2" / 51 mm	1" to 2 3/16"	100 / 25	\$ 1,450.00 / \$ 450.00	
S-CF-M064-40-X	2 1/2" / 64 mm	1 1/4" to 3"	100 / 25	\$ 1,820.00 / \$ 561.00	
S-CF-M076-48-X	3" / 76 mm	1 1/2" to 3 1/2"	50 / 25	\$ 1,088.75 / \$ 669.00	

**For the "X" value:  
 use "B" for Bulk Spool size, use "S" for Small Spool size**



**Braided Fiberglass Sleeve with Vermiculite Coating: Premium Grade.**  
**1500°F / 815°C: Continuous Rating – Higher Temperature for Shorter Periods**  
**FlameShield™ 1500 Very High Temperature & Heat Resistant Sleeve**



Effective thermal protection for wires, cables and hoses.

FlameShield™ braided fiberglass sleeve with specialty coating of Vermiculite.

- Available in thin wall (1/16 in. / 1.6mm.) and thick wall (1/8 in. / 3.18mm.).
- 1500°F / 815°C continuous exposure with excursion to 2000°F / 1093°C.
- Vermiculite adds Fire resistance, Anti-Fray and improved abrasion resistance.
- Certified to meet the requirements of ASTM E 162, ASTM E 662 & SMP 800-C.



**Braided Fiberglass Sleeve with Vermiculite Coating: Premium Grade. (Continued)**  
**1500°F / 815°C: Continuous Rating – Higher Temperature for Shorter Periods**  
**FlameShield™ 1500 Very High Temperature & Heat Resistant Sleeve**



**1500°F / 815°C continuous rating, high insulation value & excellent personnel protection**

The Vermiculite coating adds abrasion resistance and higher temperature capabilities which makes this sleeve a good insulator for hose, cable and copper or aluminum tubing. Meets Federal Railroad Administration requirements for surface flammability and rate of smoke generation.

<b>FlameShield™ Very High Temperature &amp; Heat Resistant Braided Vermiculite Coated Fiberglass Sleeve: Premium Grade</b>						
Part Number	Size in / mm / -dash			Feet – Metres per Spool Thin wall / Thick wall	Price per foot / metre Thin wall 1/16"	Price per foot / metre Thick wall 1/8"
S-FG-VC-M006-04-X	.250	6	-04	1400 - 426 / 700 - 213	\$ 0.84 / \$ 2.76	\$ 1.68 / \$ 5.51
S-FG-VC-M010-06-X	.375	10	-06	1400 - 426 / 600 - 182	\$ 0.96 / \$ 3.15	\$ 1.88 / \$ 6.17
S-FG-VC-M013-08-X	.500	13	-08	1000 - 304 / 330 - 100	\$ 1.40 / \$ 4.59	\$ 3.16 / \$ 10.37
S-FG-VC-M016-10-X	.625	16	-10	900 - 274 / 315 - 96	\$ 1.52 / \$ 4.98	\$ 3.40 / \$11.15
S-FG-VC-M019-12-X	.750	19	-12	750 - 228 / 300 - 91	\$ 1.76 / \$ 5.77	\$ 3.44 / \$ 11.29
S-FG-VC-M022-14-X	.875	22	-14	650 - 198 / 300 - 91	\$ 2.00 / \$ 6.56	\$ 3.48 / \$ 11.42
S-FG-VC-M025-16-X	1.000	25	-16	500 - 152 / 290 - 88	\$ 2.44 / \$ 8.01	\$ 3.56 / \$ 11.68
S-FG-VC-M032-20-X	1.250	32	-20	450 - 137 / 280 - 85	\$ 2.88 / \$ 9.45	\$ 4.08 / \$ 13.39
S-FG-VC-M038-24-X	1.500	38	-24	350 - 106 / 225 - 68	\$ 3.52 / \$ 11.55	\$ 4.80 / \$ 15.75
S-FG-VC-M041-26-X	1.625	41	-26	300 - 91 / 208 - 63	\$ 3.61 / \$ 11.84	\$ 4.86 / \$ 15.94
S-FG-VC-M044-28-X	1.750	44	-28	300 - 91 / 208 - 63	\$ 3.72 / \$ 12.20	\$ 5.08 / \$ 16.67
S-FG-VC-M051-32-X	2.000	51	-32	250 - 76 / 190 - 57	\$ 4.60 / \$ 15.09	\$ 6.88 / \$ 22.57
S-FG-VC-M057-36-X	2.250	57	-36	250 - 76 / 190 - 57	\$ 4.97 / \$ 16.31	\$ 7.04 / \$ 23.10
S-FG-VC-M064-40-X	2.500	64	-40	225 - 68 / 180 - 54	\$ 5.48 / \$ 17.98	\$ 7.48 / \$ 24.54
S-FG-VC-M070-44-X	2.750	70	-44	225 - 68 / 180 - 54	\$ 5.56 / \$ 18.24	\$ 7.88 / \$ 25.85
S-FG-VC-M076-48-X	3.000	76	-48	200 - 60 / 175 - 53	\$ 5.88 / \$ 19.29	\$ 9.40 / \$ 30.84
S-FG-VC-M083-52-X	3.250	83	-52	200 - 60 / 175 - 53	\$ 6.03 / \$ 19.78	\$ 9.65 / \$ 31.66
S-FG-VC-M089-56-X	3.500	89	-56	190 - 57 / 170 - 51	\$ 6.56 / \$ 21.52	\$ 10.08 / \$ 33.07
S-FG-VC-M095-60-X	3.750	95	-60	190 - 57 / 170 - 51	\$ 7.05 / \$ 23.13	\$ 10.88 / \$ 35.69
S-FG-VC-M102-64-X	4.000	102	-64	175 - 53 / 140 - 42	\$ 7.92 / \$ 25.98	\$ 11.48 / \$ 37.66
S-FG-VC-M114-72-X	4.500	114	-72	175 - 53 / 140 - 42	N/A	\$ 14.49 / \$ 47.54
S-FG-VC-M127-80-X	5.000	127	-80	120 - 36 / 100 - 30	N/A	\$ 19.32 / \$ 63.39

**For the "X" value in the p/n: use "1" to specify Thin Wall; use "2" to specify Thick Wall**

**This Product is Available By-The-Foot.**

**Minimum Order for less than 1" ID is 20 feet. Minimum order for 1" ID and larger is 10 feet.**

## Braided Fiberglass High Bulk Texturized Sleeve with Vermiculite Coating: Premium Grade

1500°F / 815°C: Continuous Rating – Higher Temperature for Shorter Periods

FlameShield™ 1500 TEX High Temperature & Heat Resistant



- FlameShield™ Braided High Bulk Texturized Premium Sleeve.
- Highest Insulation Value Sleeve Available.
- Available in Thin Wall (1/16”) and Thick Wall (1/8”).
- Texturization provides high bulk & high thermal insulation value.
- Certified to meet the requirements of ASTM E 162, ASTM E 662 & SMP 800-C.
- Vermiculite adds fire resistance, anti-fray and improved abrasion resistance.

This braided sleeve is fabricated from high quality type E fiberglass that will not burn and will withstand continuous exposure to temperatures of 1200°F / 648°C.

This material resists most acids and alkalis and is unaffected by most bleaches and solvents. It is highly flexible and conformable. The base fiber is manufactured to the specifications of ASTM D-578, ASTM committee D13, and subcommittee D13.18.

Available Plain and Vermiculite Coated.

1500°F / 815°C continuous rating, high insulation value & excellent personnel protection

### MaxSleeve™ High Bulk Texturized Braided Fiberglass Sleeve With Vermiculite Coating - Premium Grade

Part Number	Size inch / mm / -dash			Thin Wall		Thick Wall	
				Feet / Metres per spool	Price per Spool	Feet / Metres per spool	Price per Spool
S-FG-TEXVC-M010-06-X	.375	10	-6	N/A	N/A	250 / 76	\$ 1217.50
S-FG-TEXVC-M013-08-X	.500	13	-8	500 / 152	\$ 1740.00	250 / 76	\$ 1287.50
S-FG-TEXVC-M016-10-X	.625	16	-10	N/A	N/A	100 / 30	\$ 695.00
S-FG-TEXVC-M019-12-X	.750	19	-12	250 / 76	\$ 1087.50	100 / 30	\$ 740.00
S-FG-TEXVC-M025-16-X	1.000	25	-16	250 / 76	\$ 1175.00	100 / 30	\$ 785.00
S-FG-TEXVC-M032-20-X	1.250	32	-20	N/A	N/A	100 / 30	\$ 830.00
S-FG-TEXVC-M038-24-X	1.500	38	-24	250 / 76	\$ 1287.50	100 / 30	\$ 875.00
S-FG-TEXVC-M051-32-X	2.000	51	-32	N/A	N/A	100 / 30	\$ 943.00

For the “X” value in the part number:  
use “1” to specify Thin Wall; use “2” to specify Thick Wall

Thin Wall = 1/16” / 1.59mm • Thick Wall = 1/8” / 3.18mm

## Weld Splatter Protection Sleeve with Velcro® Hook & Loop Closure Scuff-Sleeve™ VC Weld Shield



- Specialty protection for hoses, wire and cables.
- Sleeve with Velcro for easy retrofit.

FG/WeldShield sleeve is fiberglass base material with a neoprene rubber coating. Temperature range -60°F to +500°F with weld splatter protection. Very good UV protection.

FG/Carbon Fiber sleeve is fabricated with a fiberglass core and carbon fiber felt. Excellent for weld protection, hot tar, foundry and turbo exhaust. Temperature range -60°F to +1800F. Metal thread and fastener construction. Excellent UV protection.

Sold in 25 foot increments up to 150 feet continuous rolls, except FG/CarbonFiber which has a 50 foot maximum roll length. Available in standard sizes; larger or custom sizes can be easily fabricated if required. Helps to organize and bundle hoses and cables.

Scuff-Sleeve™ VC: Weld Splatter Specialty Protection Sleeve					
Part Number	Size inch / mm / -dash			Price per Foot	
				FG/WeldShield A	FG/CarbonFiber B
*S-WPS-VCL-M025-16-X	1.00	25	-16	\$ 10.20	\$ 19.20
*S-WPS-VCL-M038-24-X	1.50	38	-24	\$ 13.36	N/A
S-WPS-VCL-M051-32-X	2.00	51	-32	\$ 13.52	\$ 24.20
S-WPS-VCL-M060-38-X	2.38	60	-38	\$ 14.80	N/A
S-WPS-VCL-M064-40-X	2.50	64	-40	N/A	N/A
S-WPS-VCL-M070-44-X	2.75	70	-44	\$ 16.12	N/A
S-WPS-VCL-M076-48-X	3.00	76	-48	\$ 16.56	\$ 29.16
S-WPS-VCL-M083-52-X	3.25	83	-52	\$ 18.76	N/A
S-WPS-VCL-M089-56-X	3.50	89	-56	\$ 19.66	N/A
S-WPS-VCL-M102-64-X	4.00	102	-64	\$ 19.83	\$ 30.97
S-WPS-VCL-M114-72-X	4.50	114	-72	\$ 26.28	\$ 32.43
S-WPS-VCL-M127-80-X	5.00	127	-80	\$ 27.74	\$ 34.12
S-WPS-VCL-M152-96-X	6.00	152	-96	\$ 28.31	\$ 35.76
S-WPS-VCL-M178-112-X	7.00	165	-104	\$ 34.44	\$ 46.20
S-WPS-VCL-M203-128-X	8.00	203	-128	\$ 35.87	\$ 54.33
S-WPS-VCL-M305-192-X	12.00	305	-192	\$ 55.63	N/A

For the "X" value in the part number:  
specify "A" for FG/WeldShield and "B" for FG/CarbonFiber

Width of the Velcro is 1.5" except part numbers indicated with (\*) which is .75".

**Braided Silica Sleeve - Hose, Cable, Wire, Pipe & Tube Protection**  
**1800°F / 982°C: Continuous Rating – Higher Temperature for Shorter Periods**  
**InSilMax™ Extreme High Temperature; Heat, Flame, Molten Metal & Weld Splatter Resistant**



- An alternative to asbestos and ceramic based textiles.
- Highly flexible and minimal shrinkage.
- High abrasion resistance and tensile strength.
- Melts above 3000°F / 1648°C.
- Produced from an extremely pure base fiber (SiO<sub>2</sub>) and can be used at 1800°F / 982°C continuously with short excursions to 3000°F / 1650°C.
- 1/16" (.0625") / 1.6mm nominal wall thickness (sizes below 3/4" ID have an approximate .04"/1mm nominal wall thickness).
- Silica based materials provide burn-through protection from molten metal, weld splatter and grinding sparks.

**1800°F / 982°C continuous rating, high insulation value & excellent personnel protection**

<b>InSilMax™ Extreme Temperature Heat &amp; Flame Resistant Braided Silica Sleeve</b>					
<b>Part Number</b>	<b>ID Size</b>			<b>Standard Lengths</b>	<b>Price per Foot/Metre</b>
	<b>in</b>	<b>mm</b>	<b>-dash</b>		
S-S-M006-04-X	.250	6	-04	25 - 50 - 100 ft / 7.6 - 15 - 30 m	\$ 2.05 / \$ 6.72
S-S-M010-06-X	.375	10	-06	25 - 50 - 100 ft / 7.6 - 15 - 30 m	\$ 2.13 / \$ 6.98
S-S-M013-08-X	.500	13	-08	25 - 50 - 100 ft / 7.6 - 15 - 30 m	\$ 2.82 / \$ 9.25
S-S-M016-10-X	.625	16	-10	25 - 50 - 100 ft / 7.6 - 15 - 30 m	\$ 3.12 / \$ 10.23
S-S-M019-12-X	.750	19	-12	25 - 50 - 100 ft / 7.6 - 15 - 30 m	\$ 3.74 / \$ 12.27
S-S-M022-14-X	.875	22	-14	25 - 50 - 100 ft / 7.6 - 15 - 30 m	\$ 4.18 / \$ 13.71
S-S-M025-16-X	1.000	25	-16	25 - 50 - 100 ft / 7.6 - 15 - 30 m	\$ 5.32 / \$ 17.45
S-S-M032-20-X	1.250	32	-20	25 - 50 - 100 ft / 7.6 - 15 - 30 m	\$ 6.44 / \$ 21.12
S-S-M038-24-X	1.500	38	-24	25 - 50 - 100 ft / 7.6 - 15 - 30 m	\$ 7.55 / \$ 24.76
S-S-M044-28-X	1.750	44	-28	25 - 50 - 100 ft / 7.6 - 15 - 30 m	\$ 8.76 / \$ 28.73
S-S-M051-32-X	2.000	51	-32	25 - 50 - 100 ft / 7.6 - 15 - 30 m	\$ 10.52 / \$ 34.51
S-S-M064-40-X	2.500	64	-40	25 - 50 - 100 ft / 7.6 - 15 - 30 m	\$ 12.62 / \$ 41.39
S-S-M070-44-X	2.750	70	-44	10 - 25 - 50 ft / 3 - 7.6 - 15 m	\$ 16.21 / \$ 53.17
S-S-M076-48-X	3.000	76	-48	10 - 25 - 50 ft / 3 - 7.6 - 15 m	\$ 16.38 / \$ 53.73
S-S-M083-52-X	3.250	83	-52	10 - 25 - 50 ft / 3 - 7.6 - 15 m	\$ 16.60 / \$ 54.45
S-S-M089-56-X	3.500	89	-56	10 - 25 - 50 ft / 3 - 7.6 - 15 m	\$ 16.78 / \$ 55.04
S-S-M095-60-X	3.750	95	-60	10 - 25 - 50 ft / 3 - 7.6 - 15 m	\$ 17.23 / \$ 56.51
S-S-M102-64-X	4.000	102	-64	10 - 25 - 50 ft / 3 - 7.6 - 15 m	\$ 17.83 / \$ 58.48
S-S-M114-72-X	4.500	114	-72	10 - 25 - 50 ft / 3 - 7.6 - 15 m	\$ 18.66 / \$ 61.20

**For the "X" value, insert length in feet**

**Other shorter or longer lengths may be available - please enquire**

**For sizes smaller than 1"/25mm ID – long lengths up to 300 feet may be available**

**Braided Silica Sleeve – Heavy Wall - Hose, Cable & Wire Protection**  
**1800°F / 982°C: Continuous Rating – Higher Temperature for Shorter Periods**  
**InSilMax™ +PL Extreme High Temperature; Heat, Flame, Molten Metal & Weld Splatter Resistant**

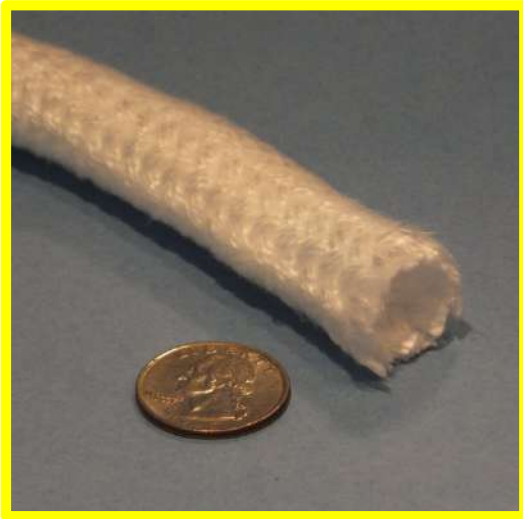

- Superior Insulation and Flame Resistance due to heavy wall construction.
- An alternative to asbestos and ceramic based textiles.
- Highly flexible and minimal shrinkage.
- High abrasion resistance and tensile strength.
- Melts above 3000°F / 1648°C.
- Produced from an extremely pure base fiber (SiO<sub>2</sub>) and can be used at 1800°F / 982°C continuously with short excursions to 3000°F / 1650°C.
- 3mm (.118") / wall thickness. Heaviest wall thickness available in this product line.
- Silica based materials provide burn-through protection from molten metal, weld splatter and grinding sparks.

1800°F / 982°C continuous rating, high insulation value & excellent personnel protection

<b>InSilMax™ +PL Extreme Temperature Heat &amp; Flame Resistant Silica Sleeve – Heavy Wall</b>						
<b>Part Number</b>	<b>ID Size in / mm / -dash</b>			<b>Spool Length feet / metre</b>	<b>Price per Spool</b>	<b>Price per Foot / minimum</b>
S-S-HD-M006-04-X	.250	6	-04	164 / 50	\$ 992.20	\$ 6.05
S-S-HD-M010-06-X	.375	10	-06	164 / 50	\$ 1,047.96	\$ 6.39
S-S-HD-M013-08-X	.500	13	-08	164 / 50	\$ 1,387.44	\$ 8.46
S-S-HD-M016-10-X	.625	16	-10	164 / 50	\$ 1,535.04	\$ 9.36
S-S-HD-M019-12-X	.750	19	-12	164 / 50	\$ 1,810.56	\$ 11.04
S-S-HD-M022-14-X	.875	22	-14	164 / 50	\$ 2,053.28	\$ 12.52
S-S-HD-M025-16-X	1.000	25	-16	164 / 50	\$ 2,614.16	\$ 15.94
S-S-HD-M032-20-X	1.250	32	-20	164 / 50	\$ 3,027.44	\$ 18.46
S-S-HD-M038-24-X	1.500	38	-24	164 / 50	\$ 3,714.60	\$ 22.65
S-S-HD-M044-28-X	1.750	44	-28	164 / 50	\$ 4,305.00	\$ 26.25
S-S-HD-M051-32-X	2.000	51	-32	164 / 50	\$ 5,169.28	\$ 31.52
S-S-HD-M064-40-X	2.500	64	-40	164 / 50	\$ 6,192.64	\$ 37.76
S-S-HD-M070-44-X	2.750	70	-44	164 / 50	\$ 7,978.60	\$ 48.65
S-S-HD-M076-48-X	3.000	76	-48	164 / 50	\$ 8,406.64	\$ 51.26
S-S-HD-M083-52-X	3.250	83	-52	164 / 50	\$ 8,980.64	\$ 54.76
S-S-HD-M089-56-X	3.500	89	-56	164 / 50	\$ 9,382.44	\$ 57.21
S-S-HD-M095-60-X	3.750	95	-60	164 / 50	\$ 10,041.72	\$ 61.23
S-S-HD-M102-64-X	4.000	102	-64	164 / 50	\$ 10,883.04	\$ 66.36
S-S-HD-M114-72-X	4.500	114	-72	164 / 50	\$ 11,867.04	\$ 72.36

For the "X" value, use "S" for Full Spool, use "F" for By-The-Foot  
This Product is available By-The-Foot – minimums may apply



## Braided Silica Sleeve - XT/HD - Hose, Cable, Wire, Pipe & Tube Protection 1900°F / 1037°C: InSilMax™ XT

Extreme High Temperature; Heat, Flame, Molten Metal & Weld Splatter Resistant



- An alternative to asbestos and ceramic based textiles.
- Highly flexible and virtually no shrinkage.
- High abrasion resistance and tensile strength.
- Melts above 3000°F / 1648°C.
- Produced from an extremely pure base fiber (SiO<sub>2</sub>) and can be used at 1900°F / 1037°C continuously with short excursions to 3000°F / 1650°C.
- 1/16" (.0625") / 1.6mm wall thickness (sizes below 3/4" ID have an approximate .04"/1mm nominal wall thickness).
- Silica based materials provide burn-through protection from molten metal, weld splatter, grinding sparks and direct flame exposure.

1900°F / 1037°C continuous rating, high insulation value & excellent personnel protection

### InSilMax™ XT Extreme Temperature Heat & Flame Resistant Silica Sleeve

Part Number	Size in / mm / -dash			Standard Lengths feet / metre	Price per Foot/Metre
S-S-XT-M006-04-X	.250	6	-04	25 - 50 - 100 ft / 7.6 - 15 - 30 m	\$ 4.10 / \$ 13.45
S-S-XT-M010-06-X	.375	10	-06	25 - 50 - 100 ft / 7.6 - 15 - 30 m	\$ 4.26 / \$ 13.97
S-S-XT-M013-08-X	.500	13	-08	25 - 50 - 100 ft / 7.6 - 15 - 30 m	\$ 5.64 / \$ 18.50
S-S-XT-M016-10-X	.625	16	-10	25 - 50 - 100 ft / 7.6 - 15 - 30 m	\$ 6.24 / \$ 20.47
S-S-XT-M019-12-X	.750	19	-12	25 - 50 - 100 ft / 7.6 - 15 - 30 m	\$ 7.48 / \$ 24.53
S-S-XT-M022-14-X	.875	22	-14	25 - 50 - 100 ft / 7.6 - 15 - 30 m	\$ 8.36 / \$ 27.42
S-S-XT-M025-16-X	1.000	25	-16	25 - 50 - 100 ft / 7.6 - 15 - 30 m	\$ 10.64 / \$ 34.90
S-S-XT-M032-20-X	1.250	32	-20	25 - 50 - 100 ft / 7.6 - 15 - 30 m	\$ 12.88 / \$ 42.25
S-S-XT-M038-24-X	1.500	38	-24	25 - 50 - 100 ft / 7.6 - 15 - 30 m	\$ 15.10 / \$ 49.53
S-S-XT-M044-28-X	1.750	44	-28	25 - 50 - 100 ft / 7.6 - 15 - 30 m	\$ 17.52 / \$ 57.47
S-S-XT-M051-32-X	2.000	51	-32	25 - 50 - 100 ft / 7.6 - 15 - 30 m	\$ 21.04 / \$ 69.01
S-S-XT-M064-40-X	2.500	64	-40	25 - 50 - 100 ft / 7.6 - 15 - 30 m	\$ 25.24 / \$ 82.79
S-S-XT-M070-44-X	2.750	70	-44	10 - 25 - 50 ft / 3 - 7.6 - 15 m	\$ 32.43 / \$ 106.37
S-S-XT-M076-48-X	3.000	76	-48	10 - 25 - 50 ft / 3 - 7.6 - 15 m	\$ 32.76 / \$ 107.45
S-S-XT-M083-52-X	3.250	83	-52	10 - 25 - 50 ft / 3 - 7.6 - 15 m	\$ 33.21 / \$ 108.93
S-S-XT-M089-56-X	3.500	89	-56	10 - 25 - 50 ft / 3 - 7.6 - 15 m	\$ 33.56 / \$ 110.07
S-S-XT-M095-60-X	3.750	95	-60	10 - 25 - 50 ft / 3 - 7.6 - 15 m	\$ 34.46 / \$ 113.03
S-S-XT-M102-64-X	4.000	102	-64	10 - 25 - 50 ft / 3 - 7.6 - 15 m	\$ 35.66 / \$ 116.96
S-S-XT-M114-72-X	4.500	114	-72	10 - 25 - 50 ft / 3 - 7.6 - 15 m	\$ 37.33 / \$ 122.44

For the "X" value, insert length in feet

Other shorter or longer lengths may be available - please enquire

**Ceramic Fiber Braided Sleeve - Premium Grade**  
**2000°F / 1093°C: CerMax™ High Temperature & Heat Resistant Sleeve**



- Soft and pliable.
- Asbestos free.
- Cuts easily to length with scissors. This sleeve does not expand.

**2000°F / 1093°C continuous rating, high insulation value**

<b>CerMax™ High Temperature &amp; Heat Resistant Braided Ceramic Fiber Sleeve - Premium</b>			
<b>Part Number</b>	<b>Nominal ID</b>	<b>Spool Length Ft</b>	<b>Price per Spool</b>
S-C-B-M003-02	1/8"	200	\$ 2620.43
S-C-B-M006-04	1/4"	200	\$ 5445.72
S-C-B-M010-06	3/8"	200	\$ 7030.68
S-C-B-M013-08	1/2"	100	\$ 5035.17
S-C-B-M019-12	3/4"	100	\$ 5537.50

**This Product is NOT Available By-The-Foot – Spools Only**

## High Alumina Content Braided Ceramic Sleeve 2300°F / 1260°C: AluMax™ High Temperature & Heat Resistant Sleeve



- Soft and pliable.
- Asbestos free.
- Cuts easily to length with scissors.
- This is a braided sleeve and has a small amount of expandibility.
- Highest temperature rated sleeve available.
- Fabricated from continuous filament fibers.
- Boron free.

2300°F / 1260°C continuous rating, high insulation value

AluMax™ High Temperature & Heat Resistant Braided Alumina Sleeve - Premium			
Part Number	Nominal ID inch / mm	Spool Length Ft / m	Price per Spool
S-ALUMINA-0.031-M00079	1/32" / 0.79	150 / 45	\$ 1046.25
S-ALUMINA-0.078-M00198	5/64" / 1.98	150 / 45	\$ 1113.75
S-ALUMINA-0.125-M00317	1/8" / 3.17	150 / 45	\$ 1612.50
S-ALUMINA-0.250-M00635	1/4" / 6.35	150 / 45	\$ 1852.50
S-ALUMINA-0.500-M0127	1/2" / 12.7	150 / 45	\$ 3622.50
S-ALUMINA-0.750-M01905	3/4" / 19.05	150 / 45	\$ 4908.75
S-ALUMINA-1.000-M02540	1" / 25.4	150 / 45	\$ 6105.00

This product is made to order - please allow 10 to 12 business days for production

**This Product is NOT Available By-The-Foot**

## Spark Plug & Ignition Wire Boot Protection Sleeve 1200°F / 648°C: FlameShield™ High Temperature & Heat Resistant Sleeve



- Soft and pliable. Asbestos free.
- Easy to install - just slide over boot or plug.
- Requires no clearance to the header - direct contact will not deteriorate the sleeve.
- Wall thickness of .085". Diameter of .75" / 19mm
- Fits straight and angled boots.
- Available in 3 lengths: 4 1/2" (short), 7 1/2" (medium) and 12" (long).
- 4 Colors: White, Red, Blue, Black
- Short sleeves are available from stock in natural (White). Colors by special order
- Medium sleeves from stock are available in all colors.
- Long sleeves are available by special order.

1200°F / 648°C continuous rating, high insulation value

FlameShield™ High Temperature & Heat Resistant Sleeves for Ignition Boot and Spark Plug Protection		
Part Number	Case Price (144)	Price Each
4 1/2" / 115mm Length S-FG-SPB-S-M019-12-X	\$ 550.00	\$ 7.64
7 1/2" / 190mm Length S-FG-SPB-M-M019-12-X	\$ 612.00	\$ 8.50
12" / 305mm Length S-FG-SPB-L-M019-12-X	\$ 977.50	\$ 13.58

For the "X" value use BK - Black, BU - Blue, RD - Red and NT for Natural (White)

## Aluminized Film Coated Fiberglass Heat Reflective Split Sleeve with Adhesive Closure

454°F / 240°C DeltaGlass™ / PET Base Material blend - Aluminum Foil Coating



- Split Sleeve for easy installation on existing wires, cables or hoses.
- Supplied in 4 foot / 1.2 metre lengths.
- Fiberglass base sleeve with PET filament interleave. Aluminum foil coating, with an aluminum foil adhesive closure strip.
- Adhesive strip closure keeps out contaminants and liquids.
- Cuts cleanly.
- Protects wiring or hoses from radiant and convective heat.
- Excellent automotive under-hood protection of wiring and hoses from engine heat.
- .042" / 1.06mm wall thickness.
- The sleeve keeps its round shape due to the PET filament interweave. Resists crushing.

DeltaGlass™ Heat Reflective Split Sleeve with Adhesive Closure				
Part Number	ID Size		Weight/Section oz / grams	Price per 4 foot Section
	inch	mm		
S-FG-AL-SLIT-ACL-0.250-M006-04	1/4"	6	1.3 / 36	\$ 7.33
S-FG-AL-SLIT-ACL-0.375-M010-06	3/8"	10	2.6 / 73	\$ 12.16
S-FG-AL-SLIT-ACL-0.500-M013-08	1/2"	13	3.3 / 93	\$ 15.60
S-FG-AL-SLIT-ACL-0.625-M016-10	5/8"	16	4.0 / 115	\$ 18.53
S-FG-AL-SLIT-ACL-0.750-M019-12	3/4"	19		\$ 22.33
S-FG-AL-SLIT-ACL-1.000-M025-16	1"	25	5.9 / 166	\$ 26.30
S-FG-AL-SLIT-ACL-1.250-M032-20	1 1/4"	32	7.5 / 212	\$ 31.43
S-FG-AL-SLIT-ACL-1.500-M038-24	1 1/2"	38	7.8 / 220	\$ 36.40
S-FG-AL-SLIT-ACL-2.000-M051-32	2"	51	9.4 / 266	\$ 48.53

This sleeve is non-expandable – please measure your application carefully.



## Aluminized Heat Reflecting Fiberglass Sleeve - PET Film Coated 1200°F / 648°C DeltaGlass™ Base Material - 454°F / 240°C Film Coating



- Protection from intense radiant heat. Reflects more than 95% of the radiant heat that contacts its surface.
- Base fabric rated for continuous operation at 1200°F / 648°C.
- This sleeve is the perfect protection for cables and hoses when radiant heat from infrared sources such as super-hot metal slabs, proximity to liquid metal, open flame/plasma or engine exhaust manifolds and piping is a concern.
- Wall thickness .025" / .635mm.
- Sleeve is supplied collapsed flat on a spool.

This high temperature and radiant heat reflective sleeve is constructed from a high-temperature fine braid fiberglass sleeve, which is then coated with highly-reflective polished aluminum. The base fabric is designed for long term continuous operation at 1000°F / 537°C, this sleeve will withstand short duration exposure up to 1200°F / 650°C.

Added protection can be achieved by layering with other sleeve materials underneath the reflective layer.

FlameShield™ Aluminized PET Film Coated Fiberglass Radiant Heat Reflective Sleeve .025" / .635mm Wall Thickness				
Part Number	Inside Diameter inch / mm / dash#	Spool Length, feet Bulk / Small	Price per Spool Bulk Spool / Small Spool	Price per Foot
S-FG-ALM-0.50-M013-08-X	0.50 / 13 / -08	250 / 100	\$ 407.50 / \$ 179.00	\$ 4.48
S-FG-ALM-0.62-M016-10-X	0.62 / 16 / -10	250 / 100	\$ 607.50 / \$ 260.00	\$ 6.50
S-FG-ALM-0.75-M019-12-X	0.75 / 19 / -12	250 / 100	\$ 712.50 / \$ 302.00	\$ 7.55
S-FG-ALM-0.87-M022-14-X	0.87 / 22 / -14	250 / 100	\$ 822.50 / \$ 346.00	\$ 8.65
S-FG-ALM-1.00-M025-16-X	1.00 / 25 / -16	250 / 100	\$ 877.50 / \$ 368.00	\$ 9.20
S-FG-ALM-1.25-M032-20-X	1.25 / 32 / -20	250 / 100	\$ 1097.50 / \$ 456.00	\$ 11.40
S-FG-ALM-1.50-M038-24-X	1.50 / 38 / -24	250 / 100	\$ 1207.50 / \$ 499.00	\$ 12.48
S-FG-ALM-1.75-M044-28-X	1.75 / 44 / -28	100 / 50	\$ 637.00 / \$ 335.00	\$ 16.77
S-FG-ALM-2.00-M051-32-X	2.00 / 51 / -32	100 / 50	\$ 790.00 / \$ 412.00	\$ 20.60
S-FG-ALM-2.50-M064-40-X	2.50 / 64 / -40	100 / 50	\$ 1123.00 / \$ 578.50	\$ 28.92
S-FG-ALM-3.00-M076-48-X	3.00 / 76 / -48	100 / 50	\$ 1150.00 / \$ 591.66	\$ 29.58

For the "X" value:  
use "B" for Bulk Spool size, use "S" for Small Spool size, use "F" for by-the-foot lengths  
This Product is available in bulk spools, shop spools and By-The-Foot

**Heat Reflecting Aluminized Film Coated Fiberglass Sleeve**  
**454°F / 240°C Convoluted High Bulk – with Aluminum Foil Coating**  
**DeltaGlass™ / PET filament Blended Base Material**



- Protection from intense radiant heat. Reflects more than 95% of the radiant heat that contacts its surface.
- Base yarn is a blend of e-fiberglass and PET filaments, rated for continuous operation at 454°F / 240°C. The PET interweave keeps the sleeve in its round form for easy wire/cable/hose insertion.
- This sleeve provides protection for cables and hoses when radiant heat from infrared sources such as super-hot metal slabs, proximity to liquid metal, open flame/plasma or engine exhaust manifolds is a concern.
- Wall thickness .045" / 1.14mm. Sleeve is supplied in a 4 foot length.

This high temperature and radiant heat reflective sleeve is constructed from a high-temperature fine braid fiberglass and PET filament interwoven base sleeve, which is then coated with highly-reflective polished aluminum foil. The base fabric is designed for long term continuous operation at 454°F / 240°C.

Added protection can be achieved by layering with other sleeve or tape materials underneath the reflective layer.

<b>FlameShield™ Aluminum Foil Coated Fiberglass Radiant Heat Reflective Convoluted Sleeve .045" / 1.14mm Wall Thickness</b>		
<b>Part Number</b>	<b>Inside Diameter inch / mm / dash#</b>	<b>Price per 4 foot Section</b>
S-FG-AL-CONVOL-0.375-M010-06	0.37 / 10 / -06	\$ 8.66
S-FG-AL-CONVOL-0.500-M013-08	0.50 / 13 / -08	\$ 11.50
S-FG-AL-CONVOL-0.620-M016-10	0.62 / 16 / -10	\$ 14.03
S-FG-AL-CONVOL-0.750-M019-12	0.75 / 19 / -12	\$ 15.40
S-FG-AL-CONVOL-0.875-M022-14	0.87 / 22 / -14	\$ 17.46
S-FG-AL-CONVOL-1.000-M025-16	1.00 / 25 / -16	\$ 19.17
S-FG-AL-CONVOL-1.250-M032-20	1.25 / 32 / -20	\$ 23.17

**This Product is only available in 4 foot length sections**

**Aluminized Heat Reflecting Fiberglass Sleeve forming Tape/Wrap;  
with adhesive strip - PET Film Coated  
1200°F / 648°C DeltaGlass™ Base Material - 454°F / 240°C Film Coating**

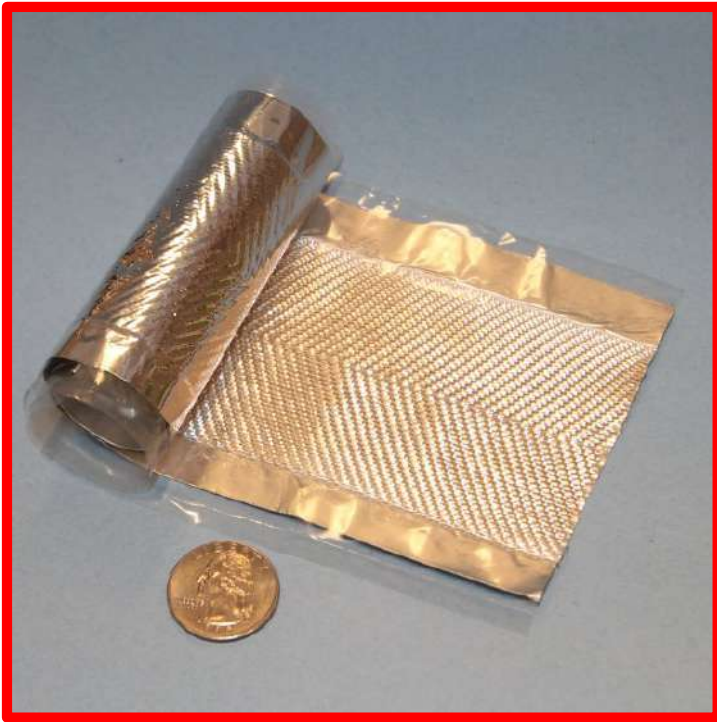

- Protection from intense radiant heat. Reflects more than 95% of the radiant heat that contacts its surface.
- Base fabric rated for continuous operation at 1200°F / 648°C. The adhesive withstands 425°F / 218°C.
- This tape wrap has a high temperature adhesive strip along its length, allowing the tape to be wrapped and formed into a sleeve around wires, cables or hoses, or wrapped spirally down the length.
- Provides protection for cables and hoses when radiant heat from infrared sources such as super-hot metal slabs, proximity to liquid metal, open flame/plasma or engine exhaust manifolds is a concern.
- Wall thickness .025".

This high temperature and radiant heat reflective tape wrap is constructed from a high-temperature fine woven fiberglass fabric substrate, which is then coated with highly-reflective polished aluminum. The base fabric is designed for long term continuous operation at 1200°F / 648°C.

Added protection can be achieved by layering with other sleeve or tape materials underneath the reflective layer.

<b>FlameShield™ Aluminized PET Film Coated Fiberglass Radiant Heat Reflective Tape Wrap for Sleeve Formation</b>				
<b>Part Number</b>	<b>Resulting Sleeve Maximum Inside Diameter inch / mm / dash#</b>	<b>Tape Width</b>	<b>Spool Length, feet Bulk / Small</b>	<b>Price per Spool Bulk Spool / Small Spool</b>
S-FG-AL-TACL-0.500-M013-08-X	0.50 / 13 / -08	1.5"	250 / 100	\$ 690.00 / \$ 293.00
S-FG-AL-TACL-0.750-M019-12-X	0.75 / 19 / -12	2.25"	250 / 100	\$ 867.50 / \$ 363.00
S-FG-AL-TACL-1.000-M025-16-X	1.00 / 25 / -16	3.75"	200 / 100	\$ 1034.00 / \$ 534.00
S-FG-AL-TACL-1.250-M032-20-X	1.25 / 32 / -20	4.5"	200 / 100	\$ 1254.00 / \$ 644.00
S-FG-AL-TACL-1.500-M038-24-X	1.50 / 38 / -24	5.25"	200 / 100	\$ 1476.00 / \$ 755.00
S-FG-AL-TACL-1.750-M044-28-X	1.75 / 44 / -28	6"	100 / 50	\$ 883.00 / \$ 458.50
S-FG-AL-TACL-2.000-M051-32-X	2.00 / 51 / -32	6.5"	100 / 50	\$ 973.00 / \$ 503.50
S-FG-AL-TACL-2.250-M057-36-X	2.25 / 57 / -36	7.5"	100 / 50	\$ 1233.00 / \$ 633.50

**For the "X" value: use "B" for Bulk Spool size, use "S" for Small Spool size**

## Radiant Heat Reflective Sleeve for Cable, Hose, Wire and Line Protection: Aluminum Foil Coated Fiberglass 1200°F / 648°C: FlameShield™: High Temperature & Radiant Heat Reflective Sleeve for Low Flex Static Applications



- Protection from intense radiant heat. Reflects more than 95% of the radiant heat that contacts its surface.
- The base fabric is rated for continuous operation at 1200°F / 648°C. The aluminum foil melts at 1220°F / 660°C. The aluminum is bonded to the fiberglass under pressure and with an adhesive that will smoke off at 425°F / 218°C - long term high temperature exposure may result in the aluminum foil being separated from the underlying fabric material.
- This sleeve provides optimum protection for cables and hoses when radiant heat from infrared sources such as super-hot metal slabs, proximity to liquid metal, open flame/plasma or engine exhaust manifolds is a concern.
- Heat reflecting layer is pure aluminum foil.
- This sleeve is designed for low flex or low movement and static applications. High flexing cycles will result in the foil cracking.
- Excellent automotive under-hood protection for wiring and hoses.

This heat reflecting sleeve is constructed from a high-temperature base fabric which is then coated with highly-reflective polished aluminum foil. The aluminum coating melts at 1220°F / 660°C, however it does take some time for the aluminum to absorb enough heat to melt – thereby it can withstand short exposure to the higher temperatures.

The sleeve is fabricated from a roll of heat reflecting fabric, and is sewn with a double lock-stitch seam utilizing high-temperature fiberglass thread. The resulting sleeve has a teardrop or tadpole profile when viewed on-end; the width of the sewn tail is typically 5/8" or 16mm. A sleeve with Velcro closure is available, making the sleeve installable on cables and hoses without having to disconnect them. Added thermal protection can be achieved by layering with other sleeve materials underneath the reflective layer.

FlameShield™ Aluminum Foil Coated Fiberglass Radiant Heat Reflective Sewn Sleeve – Low Flex & Static Applications		
Part Number	Inside Diameter inch / mm / dash#	Price per Foot 21oz/yd <sup>2</sup> / 35oz/yd <sup>2</sup> base fabric
S-FG-ALF-SWN-0.500-M013-08-X	0.50 / 13 / -08	\$ 5.48 / \$ 6.58
S-FG-ALF-SWN-0.750-M019-12-X	0.75 / 19 / -12	\$ 7.17 / \$ 8.60
S-FG-ALF-SWN-1.000-M025-16-X	1.00 / 25 / -16	\$ 8.87 / \$10.64
S-FG-ALF-SWN-1.250-M032-20-X	1.25 / 32 / -20	\$ 10.48 / \$ 12.57
S-FG-ALF-SWN-1.500-M038-24-X	1.50 / 38 / -24	\$ 12.17 / \$ 14.60
S-FG-ALF-SWN-1.750-M044-28-X	1.75 / 44 / -28	\$ 13.87 / \$ 16.64
S-FG-ALF-SWN-2.000-M051-32-X	2.00 / 51 / -32	\$ 15.53 / \$ 18.63
S-FG-ALF-SWN-2.500-M064-40-X	2.50 / 64 / -40	\$ 18.97 / \$ 22.76
S-FG-ALF-SWN-3.000-M076-48-X	3.00 / 76 / -48	\$ 22.29 / \$ 26.75
S-FG-ALF-SWN-3.500-M089-56-X	3.50 / 89 / -56	\$ 25.68 / \$ 30.82
S-FG-ALF-SWN-4.000-M102-64-X	4.00 / 102 / -64	\$ 28.97 / \$ 34.76
Other sizes available – please enquire		

For the X value: specify "21" for construction from 21 oz/yd<sup>2</sup> fabric; specify "35" for construction from 35 oz/yd<sup>2</sup> fabric

Note: The aluminum adhesion on the 35oz fabric is not as high as on the 21oz fabric, and some perforation separation of the aluminum will occur due to folding or flexing of the material.

**This Product is Available By-The-Foot; some minimums may apply**



## Aluminized PET Film Coated Fiberglass Radiant Heat Reflective Sewn Sleeve 1200°F / 648°C DeltaGlass™ Base Material - 454°F / 240°C Film Coating High Temperature & Radiant Heat Reflective Sleeve for High Flex Applications



- Protection from intense radiant heat.
- Reflects more than 95% of the radiant heat that contacts its surface.
- While the base fabric is rated for continuous operation at 1200°F / 648°C, the PET film coating is rated for continuous 392°F/200°C with no degradation. The aluminized PET coated film melts at 489°F / 254°C
- This sleeve provides optimum protection for cables and hoses when radiant heat from infrared sources such as super-hot metal slabs, proximity to liquid metal, open flame/plasma or engine exhaust manifolds is a concern.
- Heat reflecting layer is dual side aluminized film.
- This sleeve is designed for high flex or high movement applications.
- Highly popular for engine under-hood wiring & hose/tube protection

The sleeve is fabricated from a roll fabric, and is sewn with a double lock-stitch seam utilizing high-temperature thread. The resulting sleeve has a teardrop or tadpole profile when viewed on-end; the width of the sewn tail is typically 5/8" or 16mm. A sleeve with Velcro closure is available, making the sleeve installable on cables and hoses without having to disconnect them. The Velcro sleeve results in a circular sleeve profile when closed. Added protection can be achieved by layering with other sleeve materials underneath the reflective layer.

<b>FlameShield™ Aluminized PET Film Coated Fiberglass Radiant Heat Reflective Sewn Sleeve – High Flex Applications</b>		
<b>Part Number</b>	<b>Inside Diameter inch / mm / dash#</b>	<b>Price per Foot 20oz/yd<sup>2</sup> base fabric</b>
S-FG-ALM-SWN-M013-08	0.50 / 13 / -08	\$ 6.58
S-FG-ALM-SWN-M019-12	0.75 / 19 / -12	\$ 8.60
S-FG-ALM-SWN-M025-16	1.00 / 25 / -16	\$10.64
S-FG-ALM-SWN-M032-20	1.25 / 32 / -20	\$ 12.57
S-FG-ALM-SWN-M038-24	1.50 / 38 / -24	\$ 14.60
S-FG-ALM-SWN-M044-28	1.75 / 44 / -28	\$ 16.64
S-FG-ALM-SWN-M051-32	2.00 / 51 / -32	\$ 18.63
S-FG-ALM-SWN-M064-40	2.50 / 64 / -40	\$ 22.76
S-FG-ALM-SWN-M076-48	3.00 / 76 / -48	\$ 26.75
S-FG-ALM-SWN-M089-56	3.50 / 89 / -56	\$ 30.82
S-FG-ALM-SWN-M102-64	4.00 / 102 / -64	\$ 34.76
Other sizes available – please enquire		

**This Product is Available By-The-Foot**



## Aluminum Foil Coated Fiberglass Heat Reflective Sleeve with VELCRO® Brand Hook & Loop Closure

1200°F / 648°C: Aluminum Foil Coated Fiberglass High Temperature &  
Radiant Heat Reflective, For Low Flex and Static Applications



- Protection from intense radiant heat.
- Reflects more than 95% of the radiant heat that contacts its surface.
- Base fabric is rated for continuous operation at 1200°F / 648°C.
- This sleeve is the perfect protection for cables and hoses when radiant heat from infrared sources such as super-hot metal slabs, proximity to liquid metal, open flame/plasma or engine exhaust manifolds is a concern.
- VELCRO® Brand hook & loop closure allows the sleeve to be installed and removed from wire, cable, hose and pipe without disconnection.
- Designed for low flex and static applications.

Constructed from a high-temperature base fiberglass fabric which is then laminated with highly heat reflective polished aluminum foil. Designed for long term continuous operation at 650°F / 343°C, this sleeve will withstand short duration exposure up to 1200°F / 650°C. The aluminum coating melts at 1220°F / 660°C, however it does take some time for the aluminum to absorb enough heat to melt – thereby it can withstand short exposure to the higher temperatures.

The sleeve is fabricated from a roll fabric, and is then sewn with VELCRO® Brand hook and loop, allowing this sleeve to be installed and removed without disconnection of wiring, cables, hose and pipe. Sewing is performed with high temperature thread. Added protection can be achieved by layering with other sleeve materials underneath the reflective layer.

The same base fabric can be used for constructing a wide variety of protective sleeves and covers.

Aluminum Foil Coated Fiberglass Radiant Heat Protection Sleeve with VELCRO® Brand Hook & Loop		
Part Number	Inside Diameter inch / mm / dash#	Price / Foot 21oz/yd <sup>2</sup> / 35oz/yd <sup>2</sup> base fabric
S-FG-ALF-VCL-M019-12-X	0.75 / 19 / -12	\$ 11.17 / \$ 13.40
S-FG-ALF-VCL-M025-16-X	1.00 / 25 / -16	\$ 12.87 / \$ 15.44
S-FG-ALF-VCL-M032-20-X	1.25 / 32 / -20	\$ 14.48 / \$ 17.37
S-FG-ALF-VCL-M038-24-X	1.50 / 38 / -24	\$ 16.17 / \$ 19.40
S-FG-ALF-VCL-M044-28-X	1.75 / 44 / -28	\$ 17.87 / \$ 21.44
S-FG-ALF-VCL-M051-32-X	2.00 / 51 / -32	\$ 19.53 / \$ 23.44
S-FG-ALF-VCL-M064-40-X	2.50 / 64 / -40	\$ 22.97 / \$ 27.56
S-FG-ALF-VCL-M076-48-X	3.00 / 76 / -48	\$ 26.29 / \$ 31.55
S-FG-ALF-VCL-M089-56-X	3.50 / 89 / -56	\$ 29.68 / \$ 35.62
S-FG-ALF-VCL-M102-64-X	4.00 / 102 / -64	\$ 32.97 / \$ 39.56
Other sizes available – please enquire		

For the X value: specify "21" for construction from 21 oz/yd<sup>2</sup> fabric; specify "35" for construction from 35 oz/yd<sup>2</sup> fabric

**This Product is Available By-The-Foot**

**Heat Reflective Aluminized PET Coated Fiberglass Sleeve  
with VELCRO® Brand Hook & Loop Closure**  
1200°F / 648°C DeltaGlass™ Base Material - 454°F / 240°C Film Coating  
High Temperature & Radiant Heat Reflective For High Flex and  
High Movement Applications



- Protection from intense radiant heat.
- Reflects more than 95% of the radiant heat that contacts its surface.
- Base fabric is rated for continuous operation at 1000°F / 537°C.
- This sleeve is the perfect protection for cables and hoses when radiant heat from infrared sources such as super-hot metal slabs, proximity to liquid metal, open flame/plasma or engine exhaust manifolds is a concern.
- Velcro closure allows the sleeve to be installed and removed from wire, cable, hose and pipe without disconnection.
- Designed for high flex and movement applications.

Constructed from a high-temperature base fiberglass fabric which is then laminated with dual side aluminized PET film. Designed for long term continuous operation at 454°F / 240°C, this sleeve will withstand short duration exposure up to 1200°F / 648°C. The aluminum film coating melts at 460°F.

The sleeve is fabricated from a roll fabric, and is then sewn with hook & loop tape, allowing this sleeve to be installed and removed without disconnection of wiring, cables, hose and pipe. Sewing is performed with high temperature thread. The hook and loop sleeve results in a circular sleeve profile when closed. Added protection can be achieved by layering with other sleeve materials underneath the reflective layer.

The same base fabric can be used for constructing a wide variety of protective sleeves and covers.

<b>Aluminum Film Coated Fiberglass Radiant Heat Protection Sleeve with VELCRO® Brand Hook &amp; Loop</b>		
<b>Part Number</b>	<b>Inside Diameter inch / mm / dash#</b>	<b>Price / Foot 20 oz/yd<sup>2</sup> Base fabric</b>
S-FG-ALM-VCL-M019-12	0.75 / 19 / -12	\$ 13.40
S-FG-ALM-VCL-M025-16	1.00 / 25 / -16	\$ 15.44
S-FG-ALM-VCL-M032-20	1.25 / 32 / -20	\$ 17.37
S-FG-ALM-VCL-M038-24	1.50 / 38 / -24	\$ 19.40
S-FG-ALM-VCL-M044-28	1.75 / 44 / -28	\$ 21.44
S-FG-ALM-VCL-M051-32	2.00 / 51 / -32	\$ 23.44
S-FG-ALM-VCL-M064-40	2.50 / 64 / -40	\$ 27.56
S-FG-ALM-VCL-M076-48	3.00 / 76 / -48	\$ 31.55
S-FG-ALM-VCL-M089-56	3.50 / 89 / -56	\$ 35.62
S-FG-ALM-VCL-M102-64	4.00 / 102 / -64	\$ 39.56
Other sizes available – please enquire		

**This Product is Available By-The-Foot**

## Heat Reflective Aluminized PET Coated Fiberglass Sleeve with Zipper Closure

1200°F / 648°C DeltaGlass™ Base Material - 454°F / 240°C Film Coating

High Temperature & Radiant Heat Reflective For High Flex and Movement Applications



- Protection from intense radiant heat.
- Reflects more than 95% of the radiant heat that contacts its surface.
- Base fabric is 20oz/yd<sup>2</sup> and is rated for continuous operation at 1000°F / 537°C.
- This sleeve is the perfect protection for cables and hoses when radiant heat from infrared sources such as super-hot metal slabs, proximity to liquid metal, open flame/plasma or engine exhaust manifolds is a concern.
- Zipper closure allows the sleeve to be installed and removed from wire, cable, hose and pipe without disconnection.
- Designed for high flex and movement applications.
- Zippers maximum length is 150 feet. Shorter lengths for lower volume orders.

Constructed from a high-temperature base fiberglass fabric which is then laminated with dual side aluminized PET film. Designed for long term continuous operation at 454°F / 240°C, this sleeve will withstand short duration exposure up to 1200°F / 648°C. The aluminum film coating melts at 460°F.

Sleeve may be installed and removed without disconnection of wiring, cables, hose and pipe. Sewing is performed with high temperature thread. The zipper tape is nomex and the zipper teeth and guides are brass. Added protection can be achieved by layering with other sleeve materials underneath the reflective layer.

Aluminum Film Coated Fiberglass Radiant Heat Protection Sleeve with Zipper Closure		
Part Number	Inside Diameter inch / mm / dash#	Price / Foot
S-FG-ALM-ZC-M019-12	0.75 / 19 / -12	\$ 23.40
S-FG-ALM-ZC-M025-16	1.00 / 25 / -16	\$ 25.44
S-FG-ALM-ZC-M032-20	1.25 / 32 / -20	\$ 27.37
S-FG-ALM-ZC-M038-24	1.50 / 38 / -24	\$ 29.40
S-FG-ALM-ZC-M044-28	1.75 / 44 / -28	\$ 31.44
S-FG-ALM-ZC-M051-32	2.00 / 51 / -32	\$ 34.44
S-FG-ALM-ZC-M064-40	2.50 / 64 / -40	\$ 37.56
S-FG-ALM-ZC-M076-48	3.00 / 76 / -48	\$ 41.55
S-FG-ALM-ZC-M089-56	3.50 / 89 / -56	\$ 45.62
S-FG-ALM-ZC-M102-64	4.00 / 102 / -64	\$ 49.56
Other sizes available – please enquire		

**This Product is Available By-The-Foot**

## Heat Reflective Aluminum Foil Coated Fiberglass Sleeve with Snap Closure

454°F / 240°C Continuous Exposure  
High Temperature & Radiant Heat Reflective



- Protection from radiant heat. Reflects more than 95% of the radiant heat that contacts its surface.
- Base fabric is a silicone wash coated fiberglass woven fabric (the wash coating reduces release of loose fibers) of 20oz/yd<sup>2</sup> weight and is rated for continuous operation at 1000°F / 537°C. Aluminum foil coating on one side.
- This sleeve is suitable protection for wiring, cables and hoses when radiant heat from infrared sources such as hot metal slabs, proximity to liquid metal, open flame/plasma or engine exhaust manifolds is a concern.
- Snap closure allows the sleeve to be installed and removed from wire, cable, hose and pipe without disconnection.
- Maximum length is 150 feet.

Constructed from a high-temperature base fiberglass fabric which is then laminated with aluminum foil. Designed for long term continuous operation at 454°F / 240°C, this sleeve will withstand short duration exposure up to 1200°F / 648°C.

Sleeve may be installed and removed without disconnection of wiring, cables, hose and pipe. Added protection can be achieved by layering with other sleeve materials underneath the reflective layer.

Aluminum Foil Coated Fiberglass Radiant Heat Protection Sleeve with Metal Snap Closure		
Part Number	Inside Diameter inch / mm / dash#	Price / Foot
S-FG-ALF-SNAP-M019-12	0.75 / 19 / -12	\$ call
S-FG-ALF-SNAP-M025-16	1.00 / 25 / -16	\$ call
S-FG-ALF-SNAP-M028-18	1.125 / 28 / -18	\$ call
S-FG-ALF-SNAP-M038-24	1.50 / 38 / -24	\$ call
S-FG-ALF-SNAP-M051-32	2.00 / 51 / -32	\$ call
S-FG-ALF-SNAP-M070-44	2.75 / 70 / -44	\$ call
Other custom sizes available – please enquire		

**This Product is Available By-The-Foot**



## Stainless Steel Coated Fiberglass Sleeve with VELCRO® Brand Hook & Loop Closure 1200°F / 648°C: High Temperature & Radiant Heat Reflective



- Protection from intense radiant heat.
- Reflects more than 95% of the radiant heat that contacts its surface.
- Continuous operation at 1200°F / 648°C.
- This sleeve is the perfect protection for cables and hoses when radiant heat from infrared sources such as super-hot metal slabs, proximity to liquid metal, open flame/plasma or engine exhaust manifolds is a concern.
- The hook & loop closure allows the sleeve to be installed and removed from wire, cable, hose and pipe without disconnection.
- This is a very "stiff" sleeve, which if bent to form other than a straight tube, creases to take on its bent shape as required. Not intended for applications requiring flexing. If flexing is required then shorter sections may be needed to make up the required length.

Constructed from a high-temperature base fabric which is then coated with a layer of 0.002" thick polished stainless steel. Designed for long term continuous operation at 1200°F / 648°C this sleeve will withstand short duration exposure to higher temperatures. The stainless steel foil melts at 1220°F / 660°C, however it does take some time for the aluminum to absorb enough heat to melt – thereby it can withstand short exposure to higher temperatures.

The sleeve is fabricated from a roll fabric, and is then sewn with Velcro tape, allowing this sleeve to be installed and removed with disconnection of wiring, cables, hose and pipe. Sewing is performed with Kevlar or Fiberglass thread. The Velcro sleeve results in a circular sleeve profile when closed. Added protection can be achieved by layering with other sleeve materials underneath the reflective layer.

The same base fabric can be used for constructing a wide variety of protective sleeves and covers for EAF (Electric Arc Furnace) Cable Covers, Festoon covers, robotic welding machine covers, etc.

Fiberglass with Stainless Steel Foil Coating Radiant Heat Protection Sleeve with Velcro		
Part Number	Inside Diameter inch / mm / dash#	Price per Foot
S-FG-SS-VCL-M019-12	0.75 / 19 / -12	\$ 11.17
S-FG-SS-VCL-M025-16	1.00 / 25 / -16	\$ 12.87
S-FG-SS-VCL-M032-20	1.25 / 32 / -20	\$ 14.48
S-FG-SS-VCL-M038-24	1.50 / 38 / -24	\$ 16.17
S-FG-SS-VCL-M044-28	1.75 / 44 / -28	\$ 17.87
S-FG-SS-VCL-M051-32	2.00 / 51 / -32	\$ 19.53
S-FG-SS-VCL-M064-40	2.50 / 64 / -40	\$ 22.97
S-FG-SS-VCL-M076-48	3.00 / 76 / -48	\$ 26.29
S-FG-SS-VCL-M089-56	3.50 / 89 / -56	\$ 29.68
S-FG-SS-VCL-M102-64	4.00 / 102 / -64	\$ 32.97
Other sizes available – please enquire		

**This Product is Available By-The-Foot**



## EMI / RFI Shielding Split Sleeve with earthing braid & snap closure

302°F / 150°C Maximum Continuous Exposure



- Easy to install PVC sleeve with snap closure.
- Aluminized internal layer is connected to an earthing drain 15 AWG tinned copper braid for connection to ground at one end of the sleeve or both.
- Available as a 50 or 164 foot roll length.
- Sleeve may be easily cut to length and be installed/removed without disconnection of wiring or cables.
- Flexible to -70°F / -57°C.

PVC with Aluminized Side and Earthing Drain Wire for EMI/RFI Protection - Plastic Snap Closure		
Part Number	Inside Diameter inch / mm / dash#	Price / Foot
S-EMIRFI-PVC-SNAP-M010-06-X	0.375 / 10 / -06	\$ call
S-EMIRFI-PVC-SNAP-M013-08-X	0.50 / 13 / -08	\$ call
S-EMIRFI-PVC-SNAP-M019-12-X	0.75 / 19 / -12	\$ call
S-EMIRFI-PVC-SNAP-M025-16-X	1.00 / 25 / -16	\$ call
S-EMIRFI-PVC-SNAP-M028-18-X	1.125 / 28 / -18	\$ call
S-EMIRFI-PVC-SNAP-M038-24-X	1.50 / 38 / -24	\$ call
S-EMIRFI-PVC-SNAP-M051-32-X	2.00 / 51 / -32	\$ call
S-EMIRFI-PVC-SNAP-M070-44-X	2.75 / 70 / -44	\$ call
S-EMIRFI-PVC-SNAP-M101-64-X	4.00 / 101 / -64	\$ call
Other custom sizes available – please enquire		

For the “X” value: use “B” for 164 foot spool size, use “S” for 50 foot spool size

## EMI / RFI / EMF Non Magnetic Shielding Split Sleeve with Adhesive Closure 250°F / 121°C Maximum Continuous Exposure (176°F for UL version)



- Easy to install Polyurethane (PFR-8235) with nylon ripstop laminate that has an integrated copper coating; includes a tinned copper earthing braid and acrylic closure strip.
- The earthing drain 15 AWG tinned copper braid allows for connection to ground at one end of the sleeve or both.
- Minimum roll length is 50 feet. Bulk spool length is 200 feet.
- Sleeve may be easily cut to length and be installed/removed without disconnection of wiring or cables.
- Nickel and halogen free.
- Flexible to -70°F / -57°C.
- Provides Non-magnetic shielding.

### Conductive layer:

- Conductive: < 0.1 ohm/sq
- 0.005" thickness
- RoHS compliant

### Outer Shell:

- Dielectric: 800v/mil
- 0.007" thickness
- RoHS compliant
- Flame Retardant: UL-510
- Acrylic adhesive strip with release liner

### Shielding Effectiveness (E-field) MIL-STD-285

30 MHz - >60dB; 100 MHz - >80dB; 200 MHz - >75dB; 300 MHz - >75dB;  
400 to 1000 MHz - >70dB; 1000 to 7000 MHz - >58dB

**EMI / RFI / EMF Non Magnetic Shielding Split Sleeve with Adhesive Closure (Continued)**

**250°F / 121°C Maximum Continuous Exposure (176°F for UL version)**



<b>Polyurethane with laminated nylon/copper impregnation sleeve.                      integrated earthing drain wire for EMI / RFI / EMF Protection                      Acrylic Adhesive Closure</b>		
Part Number	Inside Diameter inch / mm / dash#	Price / Foot
S-EMIRFI-PU-CU-ACL-M006-04-X	0.250 / 06 / -04	\$ call
S-EMIRFI-PU-CU-ACL-M010-06-X	0.375 / 10 / -06	\$ call
S-EMIRFI-PU-CU-ACL-M013-08-X	0.50 / 13 / -08	\$ call
S-EMIRFI-PU-CU-ACL-M016-10-X	0.675 / 16 / -10	\$ call
S-EMIRFI-PU-CU-ACL-M019-12-X	0.75 / 19 / -12	\$ call
S-EMIRFI-PU-CU-ACL-M022-14-X	0.875 / 22 / -14	\$ call
S-EMIRFI-PU-CU-ACL-M025-16-X	1.00 / 25 / -16	\$ call
S-EMIRFI-PU-CU-ACL-M028-18-X	1.125 / 28 / -18	\$ call
S-EMIRFI-PU-CU-ACL-M038-24-X	1.50 / 38 / -24	\$ call
S-EMIRFI-PU-CU-ACL-M044-28-X	1.75 / 44 / -28	\$ call
S-EMIRFI-PU-CU-ACL-M051-32-X	2.00 / 51 / -32	\$ call
S-EMIRFI-PU-CU-ACL-M057-36-X	2.25 / 57 / -36	\$ call
S-EMIRFI-PU-CU-ACL-M064-40-X	2.50 / 64 / -40	\$ call
S-EMIRFI-PU-CU-ACL-M070-44-X	2.75 / 70 / -44	\$ call
S-EMIRFI-PU-CU-ACL-M076-48-X	3.00 / 76 / -48	\$ call
S-EMIRFI-PU-CU-ACL-M089-56-X	3.50 / 89 / -56	\$ call
S-EMIRFI-PU-CU-ACL-M101-64-X	4.00 / 101 / -64	\$ call
Other custom sizes available – please enquire		

**For the “X” value: use “50” for 50 foot roll size, use “200” for 200 foot bulk roll size**

## EMI / RFI Wire and Cable Harness Shielding Sleeve

302°F / 150°C: FlameShield™



- Lightweight
- Extreme Flexibility
- Excellent Electro-Magnetic Interference and Radio Frequency Interference (EMI / RFI) Shielding 1 MHz to 1 GHz
- Aramid fiber with conductivity
- Expandability
- Approximate 20% attenuation at maximum expanded diameter

- End-to-end shielding solution



FlameShield™ EMI/RFI Wire & Cable Shielding Sleeve						
Part Number	ID Size		Expansion Range		Feet per Spool	Price per Spool
	inch	mm				
S-EMI-M003-02	1/8"	3	1/16	1/4	164	\$ 1234.92
S-EMI-M010-06	3/8"	10	1/4	1/2	164	\$ 1805.64
S-EMI-M013-08	1/2"	13	3/8	3/4	164	\$ 2091.13
S-EMI-M019-12	3/4"	19	1/2	1	164	\$ 2509.20

**Not available By-The-Foot**

## Tinned Copper Metal Braided Sleeve; Tubular HoseSaver™ / CableSaver™ : 1832°F / 1000°C: MIL QQB-575 / A-A-59569



- Made from pure copper which has been tinned.
- Excellent Abrasion Protection.
- EMI / RFI Gasket & Sleeve.
- Provides rodent protection for burial cables and hoses.
- Braid angle allows for small amount of size expansion or compression.
- Clamps or tape can hold sleeve tight to underlying wire, cable or hose.
- Supplied in round form, spooled.
- Meets MIL QQB-575 / A-A-59569

Tinned Copper Braided Sleeve HoseSaver™ / CableSaver™				
Part Number	ID Size inch / mm		Spool Length, in feet	Price per Spool
			Bulk / Small Spool	Bulk / Small Spool
S-METAL-CTT-0.062-M0015-X	1/16"	1.5	250 / 100	\$ 59.38 / \$ 36.25
S-METAL-CTT-0.109-M0028-X	7/64"	2.8	250 / 100	\$ 81.25 / \$ 45.00
S-METAL-CTT-0.125-M0031-X	1/8"	3.1	250 / 100	\$ 96.25 / \$ 51.00
S-METAL-CTT-0.156-M004-X	5/32"	4	250 / 100	\$ 142.50 / \$ 69.50
S-METAL-CTT-0.203-M005-X	13/64"	5	250 / 100	\$ 235.63 / \$ 106.75
S-METAL-CTT-0.250-M006-X	1/4"	6	250 / 100	\$ 237.50 / \$ 107.50
S-METAL-CTT-0.375-M010-X	3/8"	10	250 / 100	\$ 251.25 / \$ 113.00
S-METAL-CTT-0.500-M013-X	1/2"	13	100 / 50	\$ 142.00 / \$ 83.50
* S-METAL-CTT-0.625-M016-X	5/8"	16	100 / 50	\$ 152.00 / \$ 88.50
S-METAL-CTT-0.781-M020-X	25/32"	20	100 / 50	\$ 218.00 / \$ 121.50
S-METAL-CTT-0.875-M022-X	7/8"	22	100 / 50	\$ 292.25 / \$ 158.63
S-METAL-CTT-1.000-M025-X	1"	25	100 / 50	\$ 335.00 / \$ 180.00
S-METAL-CTT-1.125-M028-X	1 1/8"	28	100 / 50	\$ 370.00 / \$ 197.50
* S-METAL-CTT-1.250-M032-X	1 1/4"	32	100 / 50	\$ 388.88 / \$ 206.50
S-METAL-CTT-1.375-M035-X	1 3/8"	35	100 / 50	\$ 440.50 / \$ 232.75
S-METAL-CTT-1.500-M038-X	1 1/2"	38	100 / 50	\$ 477.00 / \$ 251.00
S-METAL-CTT-2.000-M051-X	2	51	100 / 50	\$ 526.25 / \$ 275.63
* S-METAL-CTT-2.250-M057-X	2 1/4"	57	100 / 50	\$ 611.50 / \$ 318.25

For the "X" value: use "B" for Bulk Spool size, use "S" for Small Spool size,

Part numbers marked with \* are not specified in the MIL Spec



**Tinned Copper Metal Braided Sleeve; Tubular (Continued)**

**HoseSaver™ / CableSaver™ : 1832°F / 1000°C: MIL QQB-575 / A-A-59569**

Meets MIL QQB-575 / A-A-59569

**Electrical Specifications**

<b>Tinned Copper Braided Sleeve Electrical Specifications HoseSaver™ / CableSaver™</b>				
<b>Part Number</b>	<b>AWG of Individual Wires</b>	<b>Carriers</b>	<b>Wires per Carrier</b>	<b>Current Capacity Amps</b>
S-METAL-CTT-0.062-M0015-X	36	24	2	11
S-METAL-CTT-0.109-M0028-X	36	24	4	19
S-METAL-CTT-0.125-M0031-X	36	24	5	25
S-METAL-CTT-0.156-M004-X	36	24	10	40
S-METAL-CTT-0.203-M005-X	32	24	5	46
S-METAL-CTT-0.250-M006-X	36	24	16	53
S-METAL-CTT-0.375-M010-X	36	48	8	53
S-METAL-CTT-0.500-M013-X	36	48	11	62
* S-METAL-CTT-0.625-M016-X	34	48	8	64
S-METAL-CTT-0.781-M020-X	36	48	18	88
S-METAL-CTT-0.875-M022-X	30	48	7	100
S-METAL-CTT-1.000-M025-X	30	48	8	120
S-METAL-CTT-1.125-M028-X	30	48	9	130
* S-METAL-CTT-1.250-M032-X	30	48	10	145
S-METAL-CTT-1.375-M035-X	30	48	11	150
S-METAL-CTT-1.500-M038-X	30	48	12	165
S-METAL-CTT-2.000-M051-X	30	48	14	180
* S-METAL-CTT-2.250-M057-X	30	48	16	190

Part numbers marked with \* are not specified in the MIL Spec

**Tinned Copper Metal Braided Sleeve; Flat**  
**HoseSaver™ / CableSaver™ : 1832°F / 1000°C: MIL QQB-575 / A-A-59569**



- Made from Pure Copper. Then Tinned.
- Excellent Abrasion Protection.
- EMI / RFI Gasket & Sleeve.
- Provides Blow-out protection for hydraulic hoses.
- Provides rodent protection for burial cables and hoses.
- Braid angle allows for small amount of size expansion or compression.
- Clamps or tape can hold sleeve tight to underlying wire, cable or hose.
- Supplied in flat form, spooled.
- Meets MIL QQB-575 / A-A-59569

Tinned Copper Braided Sleeve: Flat HoseSaver™ / CableSaver™					
Part Number	ID Size inch / mm		Spool Length, in feet Bulk / Small Spool	Price per Foot Bulk / Small Spool	Price per Foot
S-METAL-CTF-0.125-M0031-X	1/8"	3.1	250 / 100	\$ 84.37 / \$ 46.25	\$ 1.39
S-METAL-CTF-0.187-M005-X	3/16"	5	250 / 100	\$ 123.12 / \$ 61.75	\$ 1.85
S-METAL-CTF-0.250-M006-X	1/4"	6	250 / 100	\$ 194.37 / \$ 90.25	\$ 2.71
* S-METAL-CTF-0.375-M010-X	3/8"	10	250 / 100	\$ 245.00 / \$ 110.50	\$ 3.32
S-METAL-CTF-0.625-M016-X	5/8"	16	100 / 50	\$ 120.50 / \$ 72.75	\$ 4.36
S-METAL-CTF-0.750-M019-X	3/4"	19	100 / 50	\$ 229.50 / \$ 127.25	\$ 7.63
* S-METAL-CTF-1.000-M025-X	1"	25	100 / 50	\$ 362.75 / \$ 193.87	\$ 11.63
S-METAL-CTF-1.375-M035-X	1 3/8"	35	100 / 50	\$ 418.00 / \$ 221.50	\$ 13.29
S-METAL-CTF-1.500-M038-X	1 1/2"	38	100 / 50	\$ 471.25 / \$ 248.12	\$ 14.88
* S-METAL-CTF-2.000-M051-X	2	51	50 / 50	\$ 526.12 / \$ 338.62	\$ 32.31
* S-METAL-CTF-3.000-M076-X	3	76	50 / 25	\$ 884.50 / \$ 454.75	\$ 54.57

**For the "X" value:**  
use "B" for Bulk Spool size, use "S" for Small Spool size, use "F" for By The Foot

Part numbers marked with \* are not specified in the MIL Spec

## Tinned Copper Metal Braided Sleeve; Flat (Continued)

**HoseSaver™ / CableSaver™ : 1832°F / 1000°C: MIL QQB-575 / A-A-59569**

Meets MIL QQB-575 / A-A-59569

### Electrical Specifications

<b>Tinned Copper Braided Sleeve Electrical Specifications HoseSaver™ / CableSaver™</b>				
<b>Part Number</b>	<b>AWG of Individual Wires</b>	<b>Carriers</b>	<b>Wires per Carrier</b>	<b>Current Capacity Amps</b>
S-METAL-CT-0.125-M0031-X	36	24	3	16
S-METAL-CT-0.187-M005-X	36	24	5	25
S-METAL-CT-0.250-M006-X	36	24	10	40
S-METAL-CT-0.375-M010-X	36	48	6	40
S-METAL-CT-0.625-M016-X	36	48	8	53
S-METAL-CT-0.750-M019-X	36	48	18	88
S-METAL-CT-1.000-M025-X	36	48	18	85
S-METAL-CT-1.375-M035-X	30	48	7	100
S-METAL-CT-1.500-M038-X	30	48	11	145
S-METAL-CT-2.000-M051-X	30	48	28	255
S-METAL-CT-3.000-M076-X	30	48	47	390

Part numbers marked with \* are not specified in the MIL Spec

**Brass Metal Braided Sleeve; Tubular**  
HoseSaver™ / CableSaver™ : 1472°F / 800°C

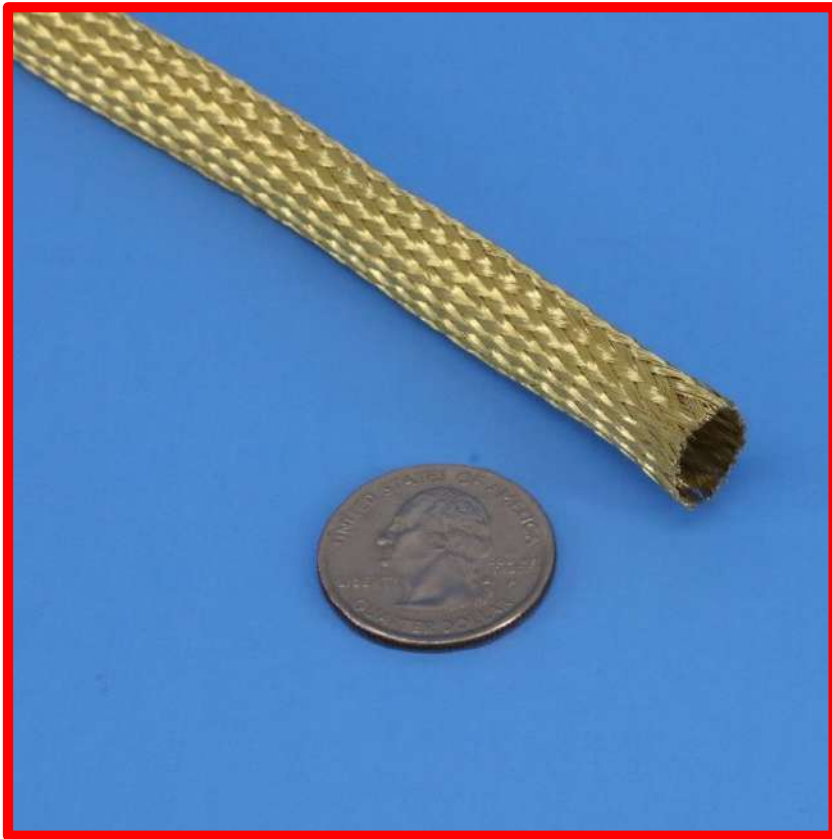

- Made from brass (copper/zinc alloy).
- Antimicrobial.
- EMI / RFI Gasket & Sleeve.
- Provides rodent protection for burial cables and hoses.
- Braid angle allows for size expansion.
- Clamps or tape can hold sleeve tight to underlying wire, cable or hose.
- Supplied in flattened form, spooled. Easily re-tubularized.
- Popular for improving aesthetic appearance of hoses and wiring on automotive and industrial equipment.

Brass Braided Sleeve HoseSaver™ / CableSaver™					
Part Number	Nominal ID inch / mm	ID Range inch / mm		Spool Length, feet Bulk / Small Spool	Price per Spool Bulk / Small
S-METAL-BRA-0.125-M0031-X	1/8 / 3.1	1/8" – 1/4"	3.1 - 6	250 / 25	\$ 337.50 / \$ 46.25
S-METAL-BRA-0.250-M006-X	1/4 / 6	1/4" – 3/8"	6 - 10	100 / 25	\$ 362.50 / \$ 103.12
S-METAL-BRA-0.375-M010-X	3/8 / 10	3/8" – 3/4"	10 – 19	100 / 25	\$ 380.00 / \$ 107.50
S-METAL-BRA-0.500-M013-X	1/2 / 12.7	1/2" – 1"	12.7 - 25	100 / 25	\$ 497.00 / \$ 137.50

Wall Thickness: 0.125 ID - .015". 0.250 ID - .027". 0.375 ID - .015". 0.500 ID - .020"

For the "X" value: use "B" for Bulk Spool size, use "S" for Small Spool size

## Stainless Steel Metal Braided Sleeve; Round – Hose Size / Heavy Duty HoseSaver™ / CableSaver™ : 2500°F / 1371°C:



- Designed for common hose sizes. Made from 304L Stainless Steel. 321 and 316 Stainless Available.
- Excellent Abrasion Protection.
- EMI / RFI Gasket & Sleeve.
- Provides Blow-out protection for hydraulic hoses.
- Provides rodent protection for burial cables and hoses.
- Also available in Bronze, Monel, Inconel Copper and Hastelloy.
- Braid angle allows for small amount of size expansion or compression.
- Clamps or tape can hold sleeve tight to underlying wire, cable or hose.
- Supplied as a round sleeve, coiled and boxed.
- Other larger ID sizes available: 16.6"; 18.9"; 20.9"; 22.9", 24.9" and 30.9".

**“Hose” Size 304L Tubular Stainless Steel Braided Sleeve  
HoseSaver™ / CableSaver™**

Part Number	Actual Size I.D. inch / mm	“Hose” Size inch / mm		Braid coverage %	Weight per foot in lbs.	Price per Foot
S-METAL-SS-HS-0.50-M013	0.50 / 13	1/4"	6	89	.08	\$ 7.21
S-METAL-SS-HS-0.67-M017	0.67 / 17	3/8"	10	91	.12	\$ 7.87
S-METAL-SS-HS-0.82-M021	0.82 / 21	1/2"	13	82	.16	\$ 8.75
S-METAL-SS-HS-1.21-M031	1.21 / 31	3/4"	19	90	.20	\$ 10.12
S-METAL-SS-HS-1.51-M038	1.51 / 38	1"	25	85	.23	\$ 13.34
S-METAL-SS-HS-1.85-M047	1.85 / 47	1 1/4"	32	83	.31	\$ 13.50
S-METAL-SS-HS-2.19-M055	2.19 / 55	1 1/2"	35	87	.40	\$ 16.87
S-METAL-SS-HS-2.60-M066	2.60 / 66	2	51	89	.62	\$ 18.00
S-METAL-SS-HS-3.23-M082	3.23 / 82	2 1/2	63	86	.70	\$ 19.13
S-METAL-SS-HS-3.78-M096	3.78 / 96	3	76	85	.80	\$ 20.25
S-METAL-SS-HS-4.85-M123	4.85 / 123	4	101	84	1.00	\$ 22.50
S-METAL-SS-HS-5.90-M150	5.90 / 150	5	127	74	1.25	\$ call
S-METAL-SS-HS-6.87-M174	6.87 / 174	6	152	90	1.60	\$ call
S-METAL-SS-HS-9.09-M231*	9.09 / 231	8	203	96	3.87	\$ call
S-METAL-SS-HS-11.18-M284*	11.18 / 284	10	254	98	6.05	\$ call
S-METAL-SS-HS-13.23-M336*	13.23 / 336	12	305	97	5.81	\$ call
S-METAL-SS-HS-14.70-M373*	14.70 / 373	14	355	99	7.89	\$ call

This Product is Available By-The-Foot: Standard lengths up to 100 feet available

A note about sizes: The “Hose” sizes refer to the nominal hose size. For example: a 1/4” “Hose” size nominal braided stainless sleeve is actually 0.48” ID, which would be the nominal OD of a 1/4” hose. For “standard” size stainless sleeve see next catalog page..

\* Braided braid



**Stainless Steel Metal Braided Sleeve**  
**XL High Coverage flat sleeve; SD Standard Coverage round sleeve**  
**2500°F / 1371°C: Standard Size HoseSaver™ / CableSaver™**



- “Standard” size stainless braid sleeve: an alternative to “Hose” size sleeve.
- Flexible size – can expand or shrink by approx 25% due to the high braid angle. Expanded position results in slightly lower braid coverage.
- Excellent Abrasion Protection.
- EMI / RFI Gasket & Sleeve.
- Provides Blow-out protection for hydraulic hoses.
- Provides rodent protection for burial cables and hoses.
- Clamps, tape or ties can hold the sleeve tight to underlying wire, cable or hose if required, and at the connector ends.
- S-METAL-SS-XL is supplied as a flat sleeve, on spools. S-METAL-SS-SD is supplied as round.
- S-METAL-SS-XL is a high coverage braid allowing greater expandability than the S-METAL-SS-SD version.

**“Standard” Size 304L Tubular Stainless Steel Braided Sleeve**  
**HoseSaver™ / CableSaver™**

Part Number	ID Size inch / mm		Size Range	Wall Thickness	Spool Length, feet Bulk / Small Spool	Price per Spool Bulk / Small Spool
S-METAL-SS-XL-0.125-M003-02-X	1/8"	3	1/16 – 11/32	.013"	250 / 100	\$ 375.00 / \$ 166.66
S-METAL-SS-XL-0.250-M006-04-X	1/4"	6	3/16 – 13/32	.013"	250 / 100	\$ 464.16 / \$ 202.33
S-METAL-SS-XL-0.375-M010-06-X	3/8"	10	¼ - 5/8	.013"	250 / 100	\$ 808.33 / \$ 340.00
S-METAL-SS-XL-0.500-M013-08-X	1/2"	13	3/8 – 3/4	.013"	100 / 50	\$ 330.66 / \$ 182.00
S-METAL-SS-XL-0.750-M019-12-X	3/4"	19	½ - 1 1/4	.013"	100 / 50	\$ 640.00 / \$ 336.66
S-METAL-SS-XL-1.000-M025-16-X	1"	25	5/8 – 1 5/16	.025"	100 / 50	\$ 866.00 / \$ 450.00
S-METAL-SS-XL-1.250-M032-20-X	1 1/4"	32	¾ - 1 3/4	.025"	100 / 50	\$ 1083.33 / \$ 558.33
S-METAL-SS-XL-1.500-M035-24-X	1 1/2"	35	1 – 2 1/8	.025"	100 / 50	\$ 1166.66 / \$ 600.00
S-METAL-SS-SD-0.500-M013-08-X	1/2"	13	1/4" - 5/8"	.025"	100 / 25	\$ 816.66 / \$ 220.83
S-METAL-SS-SD-0.625-M016-10-X	5/8"	16	3/8" - 3/4"	.025"	100 / 25	\$ 833.33 / \$ 225.00
S-METAL-SS-SD-0.750-M019-12-X	3/4"	19	1/2 - 1"	.025"	100 / 25	\$ 855.66 / \$ 230.56
S-METAL-SS-SD-1.000-M025-16-X	1"	25	3/4" - 1 1/4"	.025"	100 / 25	\$ 1039.00 / \$ 276.40
S-METAL-SS-SD-1.250-M032-20-X	1 1/4"	32	1 - 1 1/2	.035"	100 / 25	\$ 1489.00 / \$ 388.90
S-METAL-SS-SD-1.750-M044-28-X	1 3/4"	44	1 1/2 - 2 1/4	.040"	100 / 25	\$ 1816.66 / \$ 470.83

For the “X” value: use “B” for Bulk Spool size, use “S” for Small Spool size

For “Hose” size stainless sleeve see previous page

## Stainless Steel Hollow Knitted Mesh Sleeve 1200°F / 648°C:

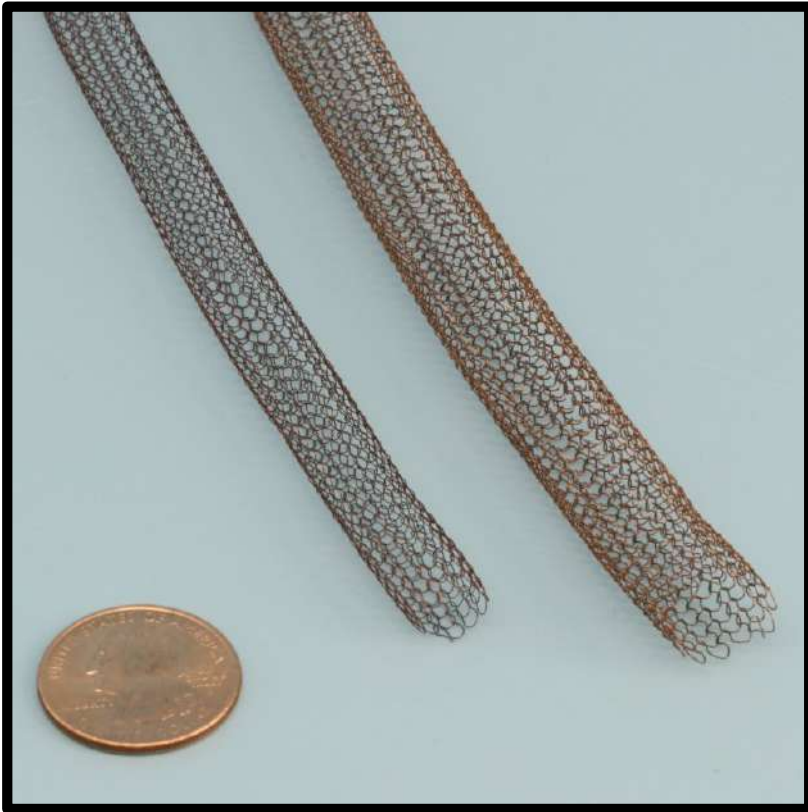

- Excellent Compressability and pushback with no compression set.
- Provides abrasion protection.
- Excellent EMI / RFI Gasket.
- Used as a bulb material in some tadpole and gasket ropes instead of solid mesh rope for added compressability of the bulb.
- 304 Stainless

304 Stainless Steel Hollow Knitted Mesh Sleeve				
ID Size inch / mm		Part Number	Feet per Carton	Price per Carton
1/4"	6	S-SS-HOLLOW-M006-04	1000	\$ 1600.00
3/8"	10	S-SS-HOLLOW-M010-06	1000	\$ 1700.00
1/2"	13	S-SS-HOLLOW-M013-08	500	\$ 1065.00
5/8"	16	S-SS-HOLLOW-M016-10	500	\$ 1115.00
3/4"	19	S-SS-HOLLOW-M019-12	500	\$ 1150.00

Please call for additional discount pricing when ordering more than 2 cartons.

## Solid Wall Stainless Steel Flexible Sleeve 1200°F / 648°C:



- Annular corrugated construction provides ability to easily flex and bend, compress and expand.
- Excellent abrasion and splash Protection.
- EMI / RFI Shield.
- Provides Blow-out protection for hydraulic hoses.
- Provides rodent protection for burial cables and hoses.
- Wires cables and hoses can be spiral wrapped with tapes prior to insertion for insulation spacing to the sidewall.
- Range of fittings and connection flanges available to terminate sleeve onto metalwork, bulkheads, etc.
- Available in Bronze, Monel, Inconel & Hastelloy

Solid Wall Stainless Steel Flexible Sleeve							
Part Number	Nominal ID inch / mm		Min Bend Radius inch		Weight per foot	Price per Foot	Mill Lengths feet
			Static	Dynamic			
S-METAL-SS-SW-M008-04	.32	8	4	6	0.09	\$ 6.83 *	30-100
S-METAL-SS-SW-M011-06	.42	11	2	4	0.12	\$ 7.73	30-100
S-METAL-SS-SW-M013-08	.52	13	3	5	0.16	\$ 7.90	30-100
S-METAL-SS-SW-M020-12	.81	20	4	6	0.26	\$ 10.23	30-100
S-METAL-SS-SW-M026-16	1.03	26	4.5	7	0.36	\$ 14.27	30-100
S-METAL-SS-SW-M033-20	1.30	33	4	11	0.45	\$ 17.27	30-60
S-METAL-SS-SW-M039-24	1.53	39	4.5	12	0.48	\$ 19.70	30-60
S-METAL-SS-SW-M052-32	2.05	52	5	13	0.70	\$ 24.97	30-60
S-METAL-SS-SW-M066-40	2.61	66	5	13	1.28	\$ 40.13	7-20
S-METAL-SS-SW-M079-48	3.10	79	7.5	16	1.53	\$ 43.97	7-20
S-METAL-SS-SW-M089-56	3.50	89	8	17	1.65	\$ 54.50 *	7-20
S-METAL-SS-SW-M101-64	3.98	101	10	20	1.95	\$ 54.30	7-20
S-METAL-SS-SW-M128-80	5.03	128	12	24	2.76	\$ 88.67	7-20
S-METAL-SS-SW-M152-96	5.98	152	15	30	3.34	\$ 92.87	7-20
S-METAL-SS-SW-M202-128	7.96	202	20	40	5.32	\$ 161.60	5-12
S-METAL-SS-SW-M248-157	9.78	248	25	50	8.71	\$ 198.85	5-12
S-METAL-SS-SW-M299-188	11.76	299	30	60	11.58	\$ 231.68	5-12
S-METAL-SS-SW-M346-217	13.62	346	35	70	14.57	\$ 753.47	5-12

This Product is Available By-The-Foot

Supplied in 304SS as standard. Except (\*) supplied in 321SS

Also Available in 321 & 316 Stainless, Bronze, Monel, Inconel and Hastelloy, please call for pricing

## Exhaust Hose Ducting - High Temperature & Heat Resistant 1500°F / 815°C: FlameShield™



- Designed for extracting fumes from metal fabrication works; refining, smelting, forging.
- Makes a great large air gap heat shield to cover piping, wires and cables.
- Constructed of a 3 ply non-flammable, lightweight and flexible ceramic coated hose, with a V4A internal stainless steel wire.
- Has an external steel wearstrip for abrasion resistance.
- Only sold in full coil lengths of 25 feet.

High Temperature Exhaust Hose / Ducting for Metal Processing							
Part Number	ID Size inch / mm		Working Pressure	Vacuum	Bend Radius	Weight / ft	Price per Foot
H-C-M102-64	4"	102	4 #	8	8"	1.5	\$ 184.00
H-C-M127-80	5"	127	3 #	6	10"	1.8	\$ 218.00
H-C-M152-96	6"	152	2 #	6	12"	2.2	\$ 262.50
H-C-M203-128	8"	203	1 #	5	16"	3	\$ 300.00
H-C-M254-160	10"	254	1 #	4	20"	3.5	\$ 371.50
H-C-M305-192	12"	305	1 #	3	24"	3.85	\$ 449.50

## Exhaust Hose for Welding Applications

300°F / 148°C:



- Designed for extracting fumes from welding operations.
- Constructed of a fiberglass base material with an aluminized PET film coating. Bonded to a helix.
- Only sold in full coil lengths of 25 feet.

High Temperature Exhaust Hose / Ducting for Welding Applications							
Part Number	ID Size inch / mm		Working Pressure	Vacuum	Bend Radius	Weight / ft	Price per Foot
H-FG-AL-M102-64	4"	102	4 #	2.7	6"	1.15	\$ 9.32
H-FG-AL-M127-80	5"	127	4 #	2.4	7.5"	1.25	\$ 10.64
H-FG-AL-M152-96	6"	152	3 #	2.2	9"	1.34	\$ 13.32
H-FG-AL-M203-128	8"	203	3 #	1.8	12"	1.75	\$ 17.98



**Wire, Cable, Harness and Hose Overbraid Service**  
Thermal Protection / Abrasion Protection / Organization

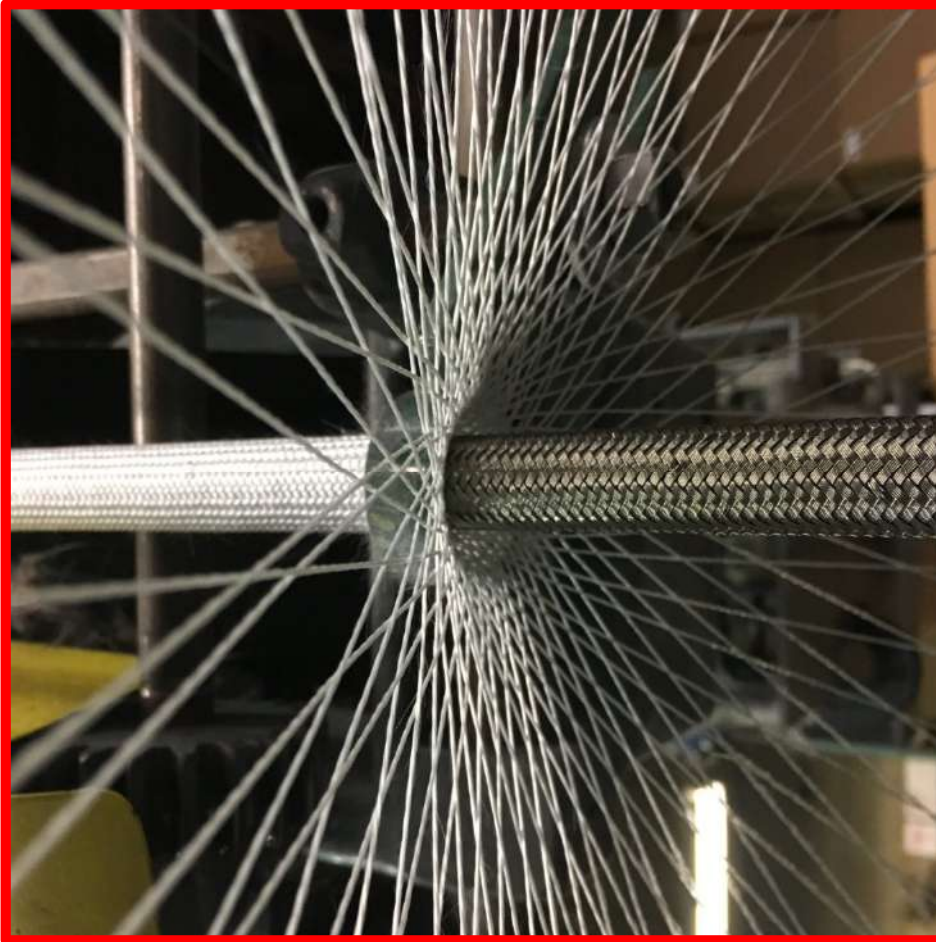

Our in-house braiding capability and experience allows us to provide exceptional quality and a timely response to protect your wiring, cables and hoses.

Available overbraid materials include e-fibreglass filament, Kevlar<sup>®</sup>, Nomex<sup>®</sup>, Nylon, PET, Polyester and Stainless wire

Please provide a description of your materials and sizing to allow us to provide an accurate quotation.

Kevlar<sup>®</sup> & Nomex<sup>®</sup> are trademarks of DuPont™

**Standard Sleeving Sizes: Inside Diameter and Wall Thickness Specifications  
For S-FS-SD (prior to coating), S-FG-S, S-FG-E Sleeve**

AWG Size	Nominal Size				Inside Diameter				Wall Thickness	
	AWG	in.	mm.	dash	Min / Max inches		Min / Max millimeter		In.	mm.
AWG 24	24	0.022	0.56	NA	0.020	0.027	0.508	0.685	0.011	0.279
AWG 22	22	0.027	0.69	NA	0.025	0.032	0.638	0.812	0.013	0.330
AWG 20	20	0.034	0.86	NA	0.032	0.039	0.812	0.990	0.013	0.330
AWG 19	19	0.038	0.96	NA	0.036	0.044	0.914	1.117	0.013	0.330
AWG 18	18	0.042	1.07	NA	0.040	0.049	1.016	1.244	0.015	0.381
AWG 17	17	0.047	1.19	NA	0.045	0.054	1.143	1.371	0.015	0.381
AWG 16	16	0.053	1.35	NA	0.051	0.061	1.295	1.549	0.015	0.381
AWG 15	15	0.059	1.50	NA	0.057	0.067	1.447	1.701	0.015	0.381
AWG 14	14	0.066	1.68	-01	0.064	0.074	1.625	1.879	0.015	0.381
AWG 13	13	0.076	1.93	NA	0.072	0.082	1.828	2.087	0.015	0.381
AWG 12	12	0.085	2.16	NA	0.081	0.091	2.057	2.311	0.015	0.381
AWG 11	11	0.095	2.41	NA	0.091	0.101	2.311	2.565	0.018	0.457
AWG 10	10	0.106	2.69	NA	0.102	0.112	2.59	2.844	0.018	0.457
AWG 9	9	0.118	3.10	NA	0.114	0.124	2.895	3.149	0.018	0.457
AWG 8	8	0.133	3.38	-02	0.129	0.141	3.276	3.581	0.018	0.457
AWG 7	7	0.148	3.76	NA	0.144	0.158	3.657	4.013	0.018	0.457
AWG 6	6	0.166	4.22	NA	0.162	0.178	4.114	4.521	0.020	0.508
AWG 5	5	0.186	4.72	-03	0.182	0.198	4.622	5.029	0.020	0.508
AWG 4	4	0.208	5.28	NA	0.204	0.224	5.181	5.689	0.020	0.508
AWG 3	3	0.234	5.94	NA	0.229	0.249	5.816	6.324	0.020	0.508
AWG 2	2	0.263	6.68	-04	0.258	0.278	6.553	7.061	0.020	0.508
AWG 1	1	0.294	7.47	NA	0.289	0.311	7.340	7.899	0.020	0.508
05	5/16	0.313	7.95	-05	0.312	0.334	7.924	8.483	0.020	0.508
AWG 0	0	0.330	8.38	NA	0.325	0.347	8.255	8.813	0.025	0.635
06	3/8	0.375	9.52	-06	0.375	0.399	9.525	10.134	0.025	0.635
07	7/16	0.438	11.12	-07	0.438	0.462	11.12	11.734	0.025	0.635
08	1/2	0.500	12.70	-08	0.500	0.524	12.70	13.309	0.025	0.635
10	5/8	0.625	15.87	-10	0.625	0.655	15.87	16.637	0.025	0.635
12	3/4	0.750	19.05	-12	0.750	0.786	19.05	19.964	0.025	0.635
14	7/8	0.875	22.22	-14	0.875	0.911	22.22	23.139	0.025	0.635
16	1	1.000	25.40	-16	1.000	1.036	25.00	26.314	na	

**Sleeving Splices**

Most sleeving is produced to NEMA TF 1 1993, which allows for the following maximum number of splices; 50 foot spool, 2 splices; 100 foot, 3 splices; 150 foot, 3 splices; 250 foot, 4 splices; 500 foot, 7 splices; 1000 foot, 10 splices. Please enquire if you require splice free lengths.



## Thermal, EMI/RFI & Abrasion Protection Materials

Fax Orders: 610-340-9054 Telephone Orders: 610-906-3549 [orders@abthermal.com](mailto:orders@abthermal.com)

---

# Protection Tapes / Insulation Tapes Silicone Tapes / Gasket Tapes Tadpole Tapes / Lacing Tapes

Tapes

FlameShield™ Kevlar Aramid Tape / Webbing Mil-T-87130 .....	2-1
FlameShield™ Glass Cloth Tape with Silicone Adhesive Mil-I-19166C .....	2-2
FlameShield™ Glass Cloth Tape with Silicone Adhesive Industrial Grade .....	2-4
FlameShield™ Silicone Rubber Coated Fiberglass Tape, 1 side coated .....	2-5
FlameShield™ Silicone Rubber Coated Fiberglass Tape, 2 side coated .....	2-7
FlameShield™ Silicone Rubber Coated Fiberglass Reinforced Tape, Premium 2 side coated .....	2-8
FlameShield™ Silicone Rubber Self-fusing Tapes .....	2-9
Tuff-Flex™ Fiberglass with soft PTFE Coating Gasket Tape, Plain & Ladder (Bolt-Hole) .....	2-62
Tuff-Flex™ Fiberglass with PTFE Resin Impregnation & Self Adhesive .....	2-65
Tuff-Flex™ Skived PTFE with Self Adhesive .....	2-68
Tuff-Flex™ Skived PTFE with Self Adhesive - High Modulus .....	2-69
Tuff-Flex™ MIL-I-23594C / A-A-59474 Skived PTFE with Self Adhesive .....	2-70
Tuff-Flex™ Expanded PTFE ePTFE Joint Seal Tape .....	2-71
Tuff-Flex™ Fiberglass with PTFE Resin Impregnation, Non Adhesive, FDA Food Grade .....	2-72
Tacky-Cloth™ Rubberized Fiberglass Tacky Cloth Gasket Tape .....	2-74
Tuff-Flex™ Rubberized Fiberglass Luting & Groove Packing .....	2-75
DeltaGlass™ Fiberglass Woven Ultra Thin Electrical Apparatus Insulating Tapes .....	2-77
DeltaGlass™ Fiberglass Knit and Woven Gasket & Insulating Tapes, Plain & Ladder (Bolt-Hole) .....	2-78
ProSil™ Fiberglass / Silica Blend Woven Gasket and Insulating Tapes, Plain & Ladder (Bolt-Hole) .....	2-86
RockGlass™ Exhaust Header Wrap .....	2-88
Vermiculite Coated DeltaGlass™ Fiberglass Woven Tape, Plain & Ladder (Bolt-Hole) .....	2-90
PowerTorque™ Automotive Manifold, Header, Turbo and Exhaust Tapes .....	2-95
InSilMax™ Silica Tapes: Slit – Folded & Stitched – Woven .....	2-96
CerMax™ Ceramic Fiber Tape .....	2-100
GraphTek™ Graphite Flexible Tape .....	2-102
Radiant Heat Reflecting Tapes .....	2-103
Weld Backing Tape .....	2-110



**Thermal, EMI/RFI & Abrasion Protection Materials**

Fax Orders: 610-340-9054 Telephone Orders: 610-906-3549 [orders@abthermal.com](mailto:orders@abthermal.com)

---

Insulated Wrap – for Pipe / Hose / Cable Protection – Steam Pipe & Heat Trace Insulation ..... 2-111

Pressure Sensitive Adhesive Spray for tape mounting ..... 2-106

Pressure Sensitive Mounting tape ..... 2-115

BoltHole™ & LadderTape™ ..... 2-122



## **Tadpole Tapes**

500°F / 260°C Silicone Rubber Tadpole Gasket Seals .....	2-118
320°F / 160°C Aramid High Strength Tadpole Gasket Seals .....	2-119
1200°F / 648°C Precision Fiberglass Tadpole Seal .....	2-120
1200°F / 648°C Fiberglass, with rope or stainless filled bulb Tadpole Seal .....	2-121
1350°F / 732°C ProSil Fiberglass/Silica Blend Tadpole Seal .....	2-122
1350°F / 732°C ProSilMax Fiberglass/Silica Blend with Wire Insert Tadpole Seal .....	2-123
1500°F / 815°C Fiberglass with Vermiculite Coating, with rope or stainless filled bulb .....	2-124
1800°F / 982°C InSilMax and InSilMax XT with rope or stainless filled bulb .....	2-125
2000°F / 1093°C CerMax with rope or stainless filled bulb .....	2-127

## **Tadpoles with Specialized Coatings**

Fiberglass with PTFE Coating with rope or stainless filled bulb Tapole Seal .....	2-129
Rubberized Fiberglass Tacky Cloth with rope or stainless filled bulb Tadpole Seal .....	2-130
Expanded PTFE ePTFE with rope or stainless filled bulb Tadpole Seal .....	2-131
TT Wear Guard Tadpole Tape Cover Mesh .....	2-132

## **Lacing Tapes**

Nylon Lacing Tape A-A-52080 / MIL-T-43435 .....	2-135
Polyester Dacron Lacing Tape A-A-52081 Type II / MIL-T-43435 .....	2-136
PTFE Fluorocarbon Teflon Lacing Tape A-A-52082 Type III / MIL-T-43435 .....	2-137
Fiberglass (E grade) Lacing Tape A-A-52083 Type IV / MIL-T-43435 .....	2-138
Nomex Meta Aramid Lacing Tape A-A-52084 Type V / MIL-T-43435 .....	2-139



**Thermal, EMI/RFI & Abrasion Protection Materials**

Fax Orders: 610-340-9054 Telephone Orders: 610-906-3549 [orders@abthermal.com](mailto:orders@abthermal.com)

---

## Kevlar® Woven Aramid Tape Premium Grade

320°F / 160°C: FlameShield™ : High Temperature & Heat Resistant, High Strength Tape / Webbing

Meets MIL-T-87130

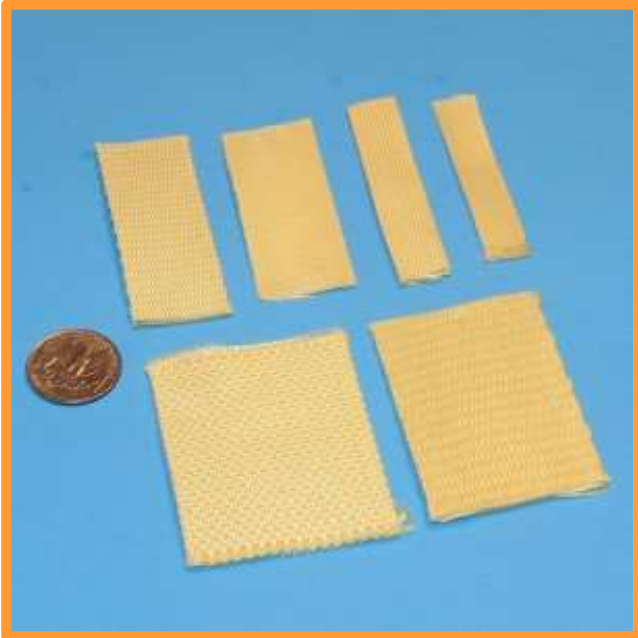

- Soft and pliable, highly flexible.
- Halogen & asbestos free.
- 20 times stronger than steel.
- Highly cut resistant.
- Available in natural (yellow) color.

320°F / 160°C maximum continuous rating with high insulation value & excellent personnel protection. Short term exposure to 572°F / 300°C

FlameShield™ High Temperature & Heat Resistant Woven Kevlar® Aramid Tape - Premium Grade				
Part Number	Width	Thickness	Tensile Strength, lbs	Price per Foot
T-KF-W-M025-16-014	1"	.014"	1500	\$ Call
T-KF-W-M025-16-025	1"	.025"	2500	\$ Call
T-KF-W-M025-16-055	1"	.055"	6000	\$ Call
T-KF-W-M038-24-023	1.5"	.023"	3000	\$ Call
T-KF-W-M038-24-057	1.5"	.057"	NA	\$ Call
T-KF-W-M038-24-069	1.5"	.069"	NA	\$ Call
T-KF-W-M038-24-079	1.5"	.079"	NA	\$ Call

## Fiberglass Glass Cloth Fine Weave Tape with Silicone Adhesive. Meets MIL-I-19166

392°F / 200°C: Glass Cloth High Temperature & Heat Resistant High Adhesion Tape -  
Electrical Insulation Tape meeting MIL-I-19166



- FlameShield™ 19166 and RG48 glass cloth tape is a high temperature fine weave fiberglass tape with a very high adhesion silicone adhesive.
- 3000 volt dielectric strength.
- .007" total thickness (5mil glass w/2 mil adhesive).
- UL recognized and meets Mil-i-19166C.
- Non Mil-Spec version available.
- Adhesion of 40oz/in.
- Tensile strength 180 lbs/in.
- NEMA Insulation class "H". Maximum continuous temperature of 356°F / 180°C.
- Practical short term exposure to 392°F / 200°C.
- Base glass material rated for 1200°F / 648°C. Silicone adhesive will "smoke" off at temperatures above 460°F / 237°C.
- This tape is widely used for electrical installations and repairs. Used on splices requiring high abrasion resistance and mechanical strength. Widely used in Marine and aviation applications as a backshell clamp bushing.



Tape used as a backshell clamp bushing

**Fiberglass Glass Cloth Fine Weave Tape with Silicone Adhesive  
Meets MIL-I-19166 (Continued)  
392°F / 200°C: Glass Cloth High Temperature & Heat Resistant High Adhesion Tape -  
Electrical Insulation Tape meeting MIL-I-19166**



<b>FlameShield™ High Temperature Fiberglass Tape with Silicone Adhesive UL Recognized &amp; Meets Mil-I-19166</b>			
<b>Part Number</b>	<b>Tape Width inch / mm</b>		<b>Price per Roll</b>
T-FG-SA-19166-M013-08	0.5	13	\$ 35.84
T-FG-SA-19166-M019-12	0.75	19	\$ 51.05
T-FG-SA-19166-M025-16	1.0	25	\$ 66.25
T-FG-SA-19166-M038-24	1.5	38	\$ 130.33
T-FG-SA-19166-M051-32	2.0	51	\$ 173.77

- 0.5" and 1" wide tapes are normally stock; 0.75", 1.5" and 2" wide are custom slit from a log and usually takes 2 to 3 days to process through our cutting room.
- This tape is slit from a master log - other widths than those listed are available.
- Standard length is 66 Feet / 20 Metres, rolled.
- RG48 part number applies.



## Glass Cloth Electrical Tape with Silicone Adhesive - Industrial 500°F / 260°C: High Temperature & Heat Resistant High Adhesion Tape - Mechanical and Electrical



- FlameShield™ glass cloth tape is a high temperature fine weave fiberglass tape with a very high adhesion silicone adhesive on one side.
- 3000 volt dielectric strength. 0.007" total thickness. Adhesion of approx 40oz/in.
- Tensile strength approx 180 lbs/in.
- This tape is widely used for electrical installations and repairs. Used on splices requiring high abrasion resistance and mechanical strength.
- Mil-Spec version meeting MIL-I-19166 available -widely used in marine and aviation applications.
- Used for masking in paint spray applications
- Used on heat sealing machinery for higher temperature performance than ptfe tapes.
- Used to finish the ends of high temperature gasket ropes, seals, tapes & tadpole gaskets.

FlameShield™ High Temperature High Strength Fiberglass Glass Cloth Tape with Silicone Adhesive			
Part Number	Tape Width		Price per Roll
	inch	mm	
T-FG-SA-M003-02	0.125	3.17	\$ 5.20
T-FG-SA-M006-04	0.250	6.35	\$ 10.40
T-FG-SA-M010-06	0.375	10	\$ 15.26
T-FG-SA-M013-08	0.500	13	\$ 20.46
T-FG-SA-M016-10	0.625	16	\$ 25.30
T-FG-SA-M019-12	0.750	19	\$ 32.23
T-FG-SA-M022-14	0.875	22	\$ 35.70
T-FG-SA-M025-16	1.00	25	\$ 40.57
T-FG-SA-M032-20	1.25	32	\$ 50.60
T-FG-SA-M038-24	1.50	38	\$ 60.66
T-FG-SA-M045-28	1.75	45	\$ 69.06
T-FG-SA-M051-32	2.00	51	\$ 79.13
T-FG-SA-M064-40	2.50	64	\$ 96.23
T-FG-SA-M076-48	3.00	76	\$ 111.50
T-FG-SA-M102-64	4.00	102	\$ 127.93
T-FG-SA-M152-96	6.00	152	\$ 192.66

Standard length is 108 feet / 36 Yards / 32.9 Metres

- This tape is slit from a master log - other widths than those listed are available.

## Silicone Rubber 1-side Coated Knitted Fiberglass Tape: *Non-Adhesive* 500°F / 260°C: High Temperature, Heat & Flame Resistant Industrial Tape & Wrap



- FlameShield™ Industrial Tape & Wrap, available in 1" width increments up to 5 inches, is made from a knitted base material. This tape has an approximate 5% elongation capability in the lengthwise direction and 15% in the width wise direction, making for easy installations due to its self compressive characteristic when slightly stretched during wrapping. Tape is 0.142" / 3.6mm thick nominal.
- A Heavy Duty version Tape & Wrap (part number AB-FTHD), available in widths from ½" through 40" wide, is made from our heaviest grade 98 oz/yd<sup>2</sup> woven material. Due to the base material being woven instead of knitted, the FTHD tape has negligible elongation capability in all directions.
- Also an excellent cold temperature tape with flexibility to -76°C for refrigeration and cryogenic applications.

500°F / 260°C continuous rating with weld splatter / molten metal splash protection.  
2200°F / 1205°C for periods up to 15 minutes and short excursions to 3000°F / 1650°C.

### FlameShield™ High Temperature Silicone Rubber 1 side Coated Fiberglass Industrial Tape & Wrap – Non Adhesive

Part Number	Tape Width inch / mm		Price per Roll	Price per Foot	Price per Metre
T-FG-SR1-1.00-M025-X	1	25	\$ 237.00	\$ 4.74	\$ 15.49
T-FG-SR1-2.00-M051-X	2	51	\$ 391.00	\$ 7.82	\$ 25.57
T-FG-SR1-3.00-M076-X	3	76	\$ 491.00	\$ 9.82	\$ 32.11
T-FG-SR1-4.00-M102-X	4	102	\$ 649.00		
T-FG-SR1-5.00-M127-X	5	127	\$ 798.00		

For the "X" value, use "R" for Full Spool, use "F" for By-The-Foot

1", 2" and 3" wide tape is available By-The-Foot

Standard length is 100 Feet / 30 Metres, rolled

High Temperature Tape & Wrap is typically used to wrap hydraulic hoses, lines, cables and wiring when a sleeve cannot be installed. The base fabric is a knitted fiberglass, and provides the tape with a small amount of elongation or stretch capability; which allows the over-wrap to hold tight onto what is being wrapped due to the compression that exists when stretched. Band clamps, wire ties or other fasteners can be used to secure the tape if necessary along the wrapped length or at the end of the wrap. An alternative to using Tape is Sleeve with VC, which is a sleeve with Velcro closure.

To aid in mounting this tape onto surfaces, FlangeStik™ pressure sensitive adhesive spray can be used to place the tape in situ temporarily. Permanent fasteners or grab strips should be installed prior to heating of the area sprayed above 200°F. The adhesive will "smoke-off" at elevated temperatures.

## Silicone Rubber 2-side Coated Knitted Fiberglass Tape: *Non-Adhesive* 500°F / 260°C: High Temperature, Heat & Flame Resistant Industrial Tape & Wrap



- FlameShield™ Industrial Tape & Wrap, available in 1" width increments up to 5 inches, is made from a knitted base material. This tape has an approximate 5% elongation capability in the lengthwise direction and 15% in the width wise direction, making for easy installations due to its self compressive characteristic when slightly stretched during wrapping. We take our 1-side coated tape and coat the exposed fiberglass side with our silicone rubber sealant paste. Tape is 0.200" / 5.1mm thick nominal.
- A Heavy Duty version Tape & Wrap (part number AB-FTHD), available in widths from ½" through 40" wide, is made from our heaviest grade 98 oz/yd<sup>2</sup> woven material. Due to the base material being woven instead of knitted, the FTHD tape has negligible elongation capability in all directions.
- Also an excellent cold temperature tape with flexibility to -76°C for refrigeration and cryogenic applications.

500°F / 260°C continuous rating with weld splatter / molten metal splash protection.  
2200°F / 1205°C for periods up to 15 minutes and short excursions to 3000°F / 1650°C.

### FlameShield™ High Temperature Silicone Rubber 2-side Coated Fiberglass Industrial Tape & Wrap – Non Adhesive

Part Number	Tape Width inch / mm		Price per Roll		
T-FG-SR2-1.00-M025-X	1	25	\$ 355.50		
T-FG-SR2-2.00-M051-X	2	51	\$ 586.50		
T-FG-SR2-3.00-M076-X	3	76	\$ 776.50		
T-FG-SR2-4.00-M102-X	4	102	\$ 973.50		
T-FG-SR2-5.00-M127-X	5	127	\$ 1297.00		

For the "X" value, use "R" for Full Spool, use "F" for By-The-Foot

1", 2" and 3" wide tape is available By-The-Foot

Standard length is 100 Feet / 30 Metres. MOQ may apply

High Temperature Tape & Wrap is typically used to wrap hydraulic hoses, lines, cables and wiring when a sleeve cannot be installed. The base fabric is a knitted fiberglass, and provides the tape with a small amount of elongation or stretch capability; which allows the over-wrap to hold tight onto what is being wrapped due to the compression that exists when stretched. Band clamps, wire ties or other fasteners can be used to secure the tape if necessary along the wrapped length or at the end of the wrap. An alternative to using Tape is Sleeve with VC, which is a sleeve with Velcro closure.

To aid in mounting this tape onto surfaces, FlangeStik™ pressure sensitive adhesive spray can be used to place the tape in situ temporarily. Permanent fasteners or grab strips should be installed prior to heating of the area sprayed above 200°F. The adhesive will "smoke-off" at elevated temperatures.

## Silicone Rubber Coated Woven Fiberglass Tape: Heavy Duty Woven Non-Adhesive

500°F / 260°C: High Temperature, Heat & Flame Resistant Heavy Duty Tape & Wrap



Heavy Duty Tape & Wrap, from ½” through 40” wide is made from our heaviest grade 98 oz/yd<sup>2</sup> material.

This tape is made from a heavy woven base fabric, which provides for very little elongation capability. This tape is stiffer than the T-FG-SR series tapes. This tape may have edge fray as it is produced by slitting a roll fabric material.

This tape can also be layered and stitched with either face on each side for use as a flange gasket. Multiply price by 2.5 times for 2 layer tape.

### FlameShield™ High Temperature Silicone Rubber Coated Fiberglass Heavy Duty Tape & Wrap

Part Number	Width inch / mm / -dash	Price per foot	Price per Metre
T-FGHD-SRHD-0.50-M013	½ / 13 / -08	\$ 2.27	\$ 7.45
T-FGHD-SRHD-0.75-M019	¾ / 19 / -12	\$ 2.77	\$ 9.09
T-FGHD-SRHD-1.00-M025	1 / 25 / -16	\$ 3.37	\$ 11.05
T-FGHD-SRHD-1.25-M032	1 ¼ / 32 / -20	\$ 3.89	\$ 12.76
T-FGHD-SRHD-1.50-M038	1 ½ / 38 / -24	\$ 4.42	\$ 14.50
T-FGHD-SRHD-1.75-M044	1 ¾ / 44 / -28	\$ 4.81	\$ 15.78
T-FGHD-SRHD-2.00-M051	2 / 51 / -32	\$ 5.01	\$ 16.43
T-FGHD-SRHD-2.25-M057	2 ¼ / 57 / -36	\$ 5.58	\$ 18.30
T-FGHD-SRHD-2.50-M064	2 ½ / 64 / -40	\$ 6.13	\$ 20.11
T-FGHD-SRHD-2.75-M070	2 ¾ / 70 / -44	\$ 6.67	\$ 21.88
T-FGHD-SRHD-3.00-M076	3 / 76 / -48	\$ 6.91	\$ 22.66
T-FGHD-SRHD-3.25-M083	3 ¼ / 83 / -52	\$ 7.81	\$ 25.62
T-FGHD-SRHD-3.50-M089	3 ½ / 89 / -56	\$ 8.68	\$ 28.47
T-FGHD-SRHD-3.75-M095	3 ¾ / 95 / -60	\$ 9.44	\$ 30.96
T-FGHD-SRHD-4.00-M102	4 / 102 / -64	\$ 10.01	\$ 32.83
T-FGHD-SRHD-4.25-M108	4 ¼ / 108 / -68	\$ 10.61	\$ 34.80
T-FGHD-SRHD-4.50-M114	4 ½ / 114 / -72	\$ 11.37	\$ 37.30
T-FGHD-SRHD-4.75-M121	4 ¾ / 121 / -76	\$ 11.97	\$ 39.26
T-FGHD-SRHD-5.00-M127	5 / 127 / -80	\$ 12.84	\$ 42.12
T-FGHD-SRHD-5.25-M133	5 ¼ / 133 / -84	\$ 13.79	\$ 45.23
T-FGHD-SRHD-5.50-M140	5 ½ / 140 / -88	\$ 14.71	\$ 48.25
T-FGHD-SRHD-5.75-M146	5 ¾ / 146 / -92	\$ 15.65	\$ 51.33
T-FGHD-SRHD-6.00-M152	6 / 152 / -96	\$ 16.58	\$ 54.38
T-FGHD-SRHD-6.25-M159	6 ¼ / 159 / -100	\$ 17.47	\$ 57.30
T-FGHD-SRHD-6.50-M165	6 ½ / 165 / -104	\$ 18.39	\$ 60.32
T-FGHD-SRHD-6.75-M171	6 ¾ / 171 / -108	\$ 19.27	\$ 63.21
T-FGHD-SRHD-7.00-M178	7 / 178 / -112	\$ 20.18	\$ 66.19
T-FGHD-SRHD-7.25-M184	7 ¼ / 184 / -116	\$ 21.09	\$ 69.18
T-FGHD-SRHD-7.50-M191	7 ½ / 191 / -120	\$ 22.02	\$ 72.23
T-FGHD-SRHD-7.75-M197	7 ¾ / 197 / -124	\$ 22.98	\$ 75.37
T-FGHD-SRHD-8.00-M203	8 / 203 / -128	\$ 23.87	\$ 78.29
T-FGHD-SRHD-8.25-M210	8 ¼ / 210 / -132	\$ 24.84	\$ 81.48
T-FGHD-SRHD-8.50-M216	8 ½ / 216 / -136	\$ 25.78	\$ 84.56
T-FGHD-SRHD-8.75-M222	8 ¾ / 222 / -140	\$ 26.81	\$ 87.94
T-FGHD-SRHD-9.00-M229	9 / 229 / -144	\$ 27.85	\$ 91.35
T-FGHD-SRHD-9.25-M235	9 ¼ / 235 / -148	\$ 28.47	\$ 93.38
T-FGHD-SRHD-9.50-M241	9 ½ / 241 / -152	\$ 28.94	\$ 94.92
T-FGHD-SRHD-9.75-M248	9 ¾ / 248 / -156	\$ 29.53	\$ 96.86
T-FGHD-SRHD-10.00-M254	10 / 254 / -160	\$ 30.03	\$ 98.50

Add “-C4” for double layer stitched (approx .27”) thick

Tape is nominal 0.1350” / 3.4mm thick nominal single layer.

This product is available By-The-Foot. For sizes larger than 10” wide please call for a quote

500°F / 260°C continuous rating with weld splatter / molten metal splash protection.

To aid in mounting this tape onto surfaces, FlangeStik™ pressure sensitive adhesive spray can be used to place the tape in situ temporarily. Permanent fasteners or grab strips should be installed prior to heating of the area sprayed above 200°F. The adhesive will “smoke-off” at elevated temperatures.



## Two-Side Silicone Rubber Coated Fiberglass Slit Tape & Wrap, Non-Adhesive, Weld Splatter Protection 500°F / 260°C: High Temperature, Heat & Flame Resistant

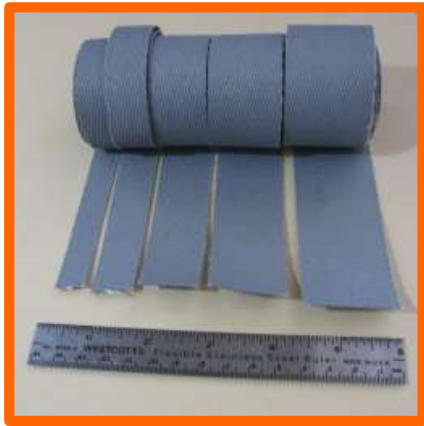

This tape is made from silicone rubber coated fabric; and is typically used as a gasket material or to wrap hydraulic hoses, lines, cables and wiring when a sleeve cannot be installed. The tape has an internal woven fiberglass fabric base which allows only a very minimal amount of bias elongation and negligible elongation along its width and length. (1-side coated tapes such as part number T-FG-SR provide higher elongation).

Tape thicknesses A is made by slitting the fabric roll, while thicknesses B and C are made by layering and stitching. Also an excellent cold temperature tape with flexibility to -76°C for refrigeration and cryogenic applications.

The edges of this tape can be sealed with our liquid silicone SleeveSeal™. This tape makes an excellent weatherproofing when sealed with SleeveSeal™ Tape or Dip or Paste.

500°F / 260°C continuous rating with weld splatter / molten metal splash protection

FlameShield™ High Temperature Two-Side Silicone Rubber Coated Fiberglass Tape & Wrap					
Part Number	Width in / mm		Price per Foot / Metre by Thickness: A / B / C		
			A	B	C
			1/16" / 1.59mm	1/8 / 3.18mm	1/4" / 6.35mm
T-FG-SR-S2-M025-16-X	1.0	25	\$ 1.92 / \$ 6.30	\$ 3.84 / \$ 12.60	\$ 7.68 / \$ 25.19
T-FG-SR-S2-M032-20-X	1.25	32	\$ 2.40 / \$ 7.87	\$ 4.80 / \$ 15.74	\$ 9.60 / \$ 31.49
T-FG-SR-S2-M038-24-X	1.5	38	\$ 2.88 / \$ 9.45	\$ 5.76 / \$ 18.89	\$ 11.52 / \$ 37.79
T-FG-SR-S2-M051-32-X	2.0	51	\$ 3.84 / \$ 12.60	\$ 7.68 / \$ 25.19	\$ 15.36 / \$ 50.38
T-FG-SR-S2-M064-40-X	2.5	64	\$ 4.80 / \$ 15.74	\$ 9.60 / \$ 31.49	\$ 19.20 / \$ 62.98
T-FG-SR-S2-M076-48-X	3.0	76	\$ 5.76 / \$ 18.89	\$ 11.52 / \$ 37.79	\$ 23.04 / \$ 75.57
T-FG-SR-S2-M089-56-X	3.5	89	\$ 6.72 / \$ 22.04	\$ 13.44 / \$ 44.08	\$ 26.88 / \$ 88.17
T-FG-SR-S2-M102-64-X	4.0	102	\$ 7.68 / \$ 25.19	\$ 15.36 / \$ 50.38	\$ 30.72 / \$ 100.76
T-FG-SR-S2-M127-80-X	5.0	127	\$ 9.60 / \$ 31.49	\$ 19.20 / \$ 62.98	\$ 38.40 / \$ 125.95
T-FG-SR-S2-M152-96-X	6.0	152	\$ 11.52 / \$ 37.79	\$ 23.04 / \$ 75.57	\$ 46.08 / \$ 151.14
T-FG-SR-S2-M178-112-X	7.0	178	\$ 13.44 / \$ 44.08	\$ 26.88 / \$ 88.17	\$ 53.76 / \$ 176.33
T-FG-SR-S2-M203-128-X	8.0	203	\$ 15.36 / \$ 50.38	\$ 30.72 / \$ 100.76	\$ 61.44 / \$ 201.52
T-FG-SR-S2-M254-160-X	10.0	254	\$ 19.20 / \$ 62.98	\$ 38.40 / \$ 125.95	\$ 76.88 / \$ 252.17
T-FG-SR-S2-M305-192-X	12.0	305	\$ 23.04 / \$ 75.57	\$ 46.08 / \$ 151.14	\$ 92.16 / \$ 302.29
T-FG-SR-S2-M355-224-X	14.0	355	\$ 26.88 / \$ 88.17	\$ 53.76 / \$ 176.33	\$ 107.52 / \$ 352.67
T-FG-SR-S2-M457-288-X	18.0	457	\$ 34.56 / \$ 113.36	\$ 69.12 / \$ 226.71	\$ 138.24 / \$ 453.43
T-FG-SR-S2-M508-320-X	20.0	508	\$ 38.40 / \$ 125.95	\$ 76.80 / \$ 251.91	\$ 153.60 / \$ 503.81

- For the "X" value, specify A, B or C in part number to correspond to the desired thickness  
A1 = 1/16" / .0625" / 1.59mm    B2 = 1/8" / .125" / 3.18mm    C4 = 1/4" / .250" / 6.35mm

Band clamps, wire ties or other fasteners can be used to secure the tape if necessary along the wrapped length or at the end of the wrap. An alternative to using this tape is to use sleeve with Velcro closure. For gasket applications, this tape can usually be secured with a silicone adhesive such as our AB-HTG-165 (general purpose high temperature silicone adhesive) or AB-SRB-201 (specialty adhesive for bonding silicone rubber components together). For larger sizes than 12" please call for a quote

To aid in mounting this tape onto surfaces, FlangeStik™ pressure sensitive adhesive spray can be used to place the tape in situ temporarily. Permanent fasteners or grab strips should be installed prior to heating of the area sprayed above 200°F. The adhesive will "smoke-off" at elevated temperatures.



**Silicone Rubber Coated Fiberglass Reinforced Tape  
 Premium Grade (No Adhesive)  
 -100°F to 450°F / -73°C to 232°C: High Temperature Heat & Chemical Resistance  
 DeltaGlass™**

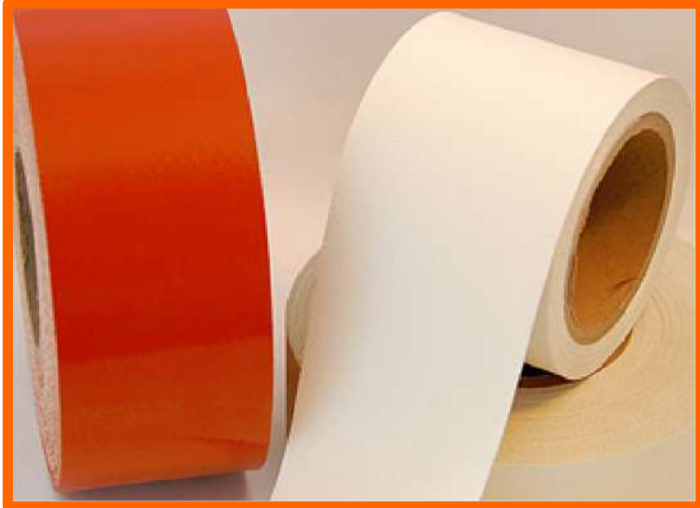

- e-fiberglass core.
- Silicone rubber coating.
- Excellent release properties.
- High dielectric factor.

This fabric offers high temperature range with excellent resistance to almost all solvents, caustics and acids. Non-porous finish. Welding splatter, spark and molten splash resistant.

The base fabric is rated to 1200°F / 648°C.

Used as gaskets, safety curtains, conveyor belts. Used to wrap other insulation materials on piping to provide contamination protection.

**Any Width Is Available Between 1/2" and 36 inches**

450°F / 232°C continuous rating, high insulation value & excellent personnel protection

<b>High Temperature, Heat &amp; Chemical Resistance DeltaGlass™ E-glass Fiberglass Tape with Silicone Rubber Coating – Premium Grade</b>				
<b>Part Number</b>	<b>Thickness, in.</b>	<b>Tensile warp lbs/in</b>	<b>Weight oz/yd<sup>2</sup></b>	<b>Price per Inch of Roll Width (Roll Length: 18 yd / 36 yd)</b>
T-FG-SR2-P-009339-10-W	.0093	74	10	\$ 38.35 / \$ 76.70
T-FG-SR2-P-015039-16-R/W	.0150	229	16	\$ 34.93 / \$ 69.85
T-FG-SR2-P-020339-22-R	.0203	263	22	\$ 36.10 / \$ 72.20
T-FG-SR2-P-022039-22-R/W	.0220	285	22	\$ 54.08 / \$ 108.15
T-FG-SR1-P-023037.5-24-R*	.0230	350	24	\$ 51.09 / \$ 102.17
T-FG-SR2-P-029539-32-R	.0295	286	32	\$ 65.47 / \$ 130.93
T-FG-SR2-P-040039-41-W	.0400	410	41	\$ 68.87 / \$ 137.73

- \* This tape is coated with a saturation process that leave the reverse side fabric sealed but with no extra coverage over the base fabric that the other versions have.
- W at the end of the part number indicates white color. R indicates red color.

## Silicone Rubber Self Fusing Compression & Stretch Electrical Insulating Tape (Meets MIL Spec MIL-I-46852 & A-A-59163)

-60°F to +400°F / -51°C to 204°F: FlameShield™ Self Binding / Self-Fusing / Self Amalgamating Tape - High Temperature, Heat & Flame Resistant



- Self-bonds / self fuses / self amalgamating tape. No residue when removed. Starts fusing within minutes; fully bonded within hours. Excellent cold temperature performance. Low water absorption.
- Tested to:
  - ASTM D 149; provides minimum 400 V/mil. for .010" to .030" thick tape, 300 V/mil for .040" thick tape and 250 V/mil for .060" thick tape.
  - ASTM D 412; provides minimum 700 psi tensile strength and minimum 300% elongation.
  - ASTM D 2240; Durometer (Shore A); 55. Other test data available.
- Excellent for sealing ends of firesleeve: prevents sleeve from absorbing contamination and wicking liquids. Excellent for wrapping electrical & mechanical connections and splices. Makes clean and neat installations of cables, wires and hoses. Makes an instant separation bumper and provides vibration dampening.
- Meets Mil-I-46852, AA59163 and ABS 5334 specifications. Certificate of Conformity available.
- Cross Reference Equivalents Available to MOX 600R and 600T levelwrap series; 602-1, 603-1, 604-1, 605-1, 606-1, 607-1. McDonnell Douglas / Boeing DMS-2186 Type I & II, McDonnell Douglas Helicopter HS5215, General Dynamics P5384, Martin Marietta MMS 517-6 Type II, McDonnell Douglas P.S. 17115, ST0130RB0078 Type I, 3003M70P01, MS70T09-S, WS1363A, Premier Farnell 810112, Safe Flight 59562-5, PLYSIL3455, TYT200-1, 66N, 67N and various NATO / National Stock Numbers (NSN).
- Standard roll length is 36 feet / 12 Yards / 10.9 Metres; other lengths available.
- Amalgamating time: Room temperature; 24 hours / at 120°C; 120 minutes / at 150°C; 35 minutes / at 200°C; 20 minutes / at 250°C; 15 minutes. Tested for short duration fluid resistance: Jet Fuel (JP5), Hydraulic Fluid (Skydrol 500B4), Mineral Oil (NATO 0142), Synthetic Oil (NATO 0156), MIL-C-87836 & Foran 141B cleaning fluids, MIL-A-8243 cooling fluid.

These tapes are guaranteed to meet specification for 1 year from date of manufacture providing tapes are stored dry at 21°C +/- 3°C or 70°F +/- 5°F. Standard tapes have an interleaved liner of polyethylene. Polyester liner available.

Type II tapes have a center guideline stripe to assist in making 50% overwraps. The triangular profile version tape allows for minimal ridge lines, providing wire and cable splices and joints with an almost totally smooth surface (prevents snagging when splice is pulled through obstructions).

<b>FlameShield™ MIL Spec High Temperature Silicone Self Fusing                      Compression/Stretch Electrical Insulating Tape</b> <b>Meets MIL-I-46852 / A-A-59163 / ABS 5334 Specifications - Type I and Type II</b>				
Part Number	Tape Width Inches / mm	Thickness inches / mm	Color / Type / Profile	Single Roll Price Per Roll
T-SR-M013-08-RXX-20	1/2 / 12.7	0.020 / 0.508	Black or Red / I / Rectangular	\$ 29.37
T-SR-M013-08-RXX-30	1/2 / 12.7	0.030 / 0.760	Black or Red / I / Rectangular	\$ 37.16
T-SR-M016-10-RXX-20	5/8 / 15.7	0.020 / 0.508	Black or Red / I / Rectangular	\$ 30.17
T-SR-M019-12-RXX-20	3/4 / 19	0.020 / 0.508	Black or Red / I / Rectangular	\$ 31.96
T-SR-M025-16-RXX-10	1 / 25.4	0.010 / 0.250	Black or Red / I / Rectangular	\$ 29.37
T-SR-M025-16-TXX-20	1 / 25.4	0.020 / 0.508	Black or Red / II / Triangular	\$ 33.80
T-SR-M025-16-RXX-20	1 / 25.4	0.020 / 0.508	Black or Red / I / Rectangular	\$ 34.71
T-SR-M025-16-TXX-40	1 / 25.4	0.040 / 1.000	Black or Red / II / Triangular	\$ 37.91
T-SR-M025-16-RXX-40	1 / 25.4	0.040 / 1.000	Black or Red / I / Rectangular	\$ 39.64
T-SR-M038-24-RXX-20	1 1/2 / 38.1	0.020 / 0.508	Black or Red / I / Rectangular	\$ 48.77
T-SR-M038-24-RXX-12	1 1/2 / 38.1	0.012 / 0.304	Black or Red / I / Rectangular	\$ 38.47
T-SR-M051-32-RXX-20	2 / 50.8	0.020 / 0.508	Black or Red / I / Rectangular	\$ 57.13
T-SR-M051-32-TXX-20	2 / 50.8	0.020 / 0.508	Black or Red / II / Triangular	\$ 48.86
<b>Triangular Type II Tapes Only: .020" has a blue guideline / .040" has a green guideline</b>				

**Please enquire for pricing on widths and thicknesses other than those listed above.**

- Standard roll length is 36 feet / 12 Yards / 10.9 Metres; other lengths available.
- For the XX value in the part number (color code): OR = Oxide-Red, BK = Black. Other colors available.
- Certificate of Conformity: Add \$6.00 for individual roll CofC. Lot/Batch CofC \$25.00 per order line item.
- Test Report: Add \$75.00 per order line item.

Amalgamating time: Room temperature; 24 hours / at 120°C; 120 minutes / at 150°C; 35 minutes / at 200°C; 20 minutes / at 250°C; 15 minutes. Tested for short duration fluid resistance: Jet Fuel (JP5), Hydraulic Fluid (Skydrol 500B4), Mineral Oil (NATO 0142), Synthetic Oil (NATO 0156), MIL-C-87836 & Foran 141B cleaning fluids, MIL-A-8243 cooling fluid.

These tapes are guaranteed to meet specification for 1 year from date of manufacture providing tapes are stored dry at 21°C +/- 3°C or 70°F +/- 5°F. Standard tapes have an interleaved liner of polyethylene. Polyester liner available.

Type II tapes have a center guideline stripe to assist in making 50% overwraps. The triangular profile version tape allows for minimal ridge lines, providing wire and cable splices and joints with an almost totally smooth surface (prevents snagging when splice is pulled through obstructions).

## FlameShield™ MIL Spec Silicone Rubber Self Fusing Compression & Stretch Electrical Insulating Tape - Technical Data

<b>Specifications for FlameShield™ Silicone Rubber Tape (MIL-I-46852 &amp; A-A-59163) Class 1 – Type I and Type II</b>			
Property	Standard	Nominal Test Result or Tolerance	Test Method
Thickness: 1" wide tape  1.5" wide tape 2.0" wide tape	.010" .020" .030" .040" .020" .020"	+/- .002"	N/A
Width	0.50", 0.75", 1.00", 1.50", 2.00"	+/- .020"	N/A
Length	36 feet / 12 yards / 10.9m	+/- 6.00"	N/A
Color	Oxide-Red or Black	N/A	N/A
Guideline Color (Type II)	.020" Tapes: Blue .030" Tapes: White .040" Tapes: Green	N/A	N/A
Operating Temperature	-60°C to +260°C -76°F to +500°F	N/A	N/A
Brittle Temperature	-65°C / -85°F	N/A	N/A
Interleave Material	.002" thick Mylar	N/A	N/A
Tensile Strength	700 psi (minimum)	1100	ASTM D412 / D119
Dielectric Strength	.020" Tape: 400 V/mm .030" Tape: 400 V/mm .040" Tape: 300 V/mm	575	ASTM D-149
Dielectric Constant		2.94 @ 1Khz	ASTM D150
Volume Resistivity	1 x 10 <sup>14</sup> ohms/cm <sup>3</sup>	3 x 10 <sup>14</sup>	ASTM D149
Elongation	300% (minimum)	700	ASTM D412 / D119
Tear Strength	85 psi (minimum)	146	ASTM D624
Bond Strength (1" Width)	2 lbs (minimum)	5.5	ASTM D2148
Adhesion	Shall not unwind more than 1.0" after 3 minutes with 600g load	0.12"	ASTM D2148
Inclined Mandrel Tack Test (inch)		0.25	ASTM D2148
Water absorption (by wt)	3% Maximum	0.9%	FED-STD-601 Method 6251
Dissipation Factor		<0.0004 @ 1 KHz	ASTM D150
Hardness, durometer Shore A	55 - 65	55	ASTM D2148 / D2240
Flame Test		Pass	FAA 60 Sec Vertical



**MIL-I-46852-1I0010 / MIL-I-46852-1I0020 / MIL-I-46852-1I0030**

**MIL-I-46852-1I0040**

**Class 1 - Type I**

**MIL-I-46852-1II0020 / MIL-I-46852-1II0030 / MIL-I-46852-1II0040**

**Class 1 - Type II**

## Silicone Rubber Self Fusing Electrical Insulating Tape

500°F / 260°C: FlameShield™ Self Binding / Self-Fusing / Self Amalgamating Tape -  
High Temperature, Heat & Flame Resistant



- Self-bonds / self fuses / self amalgamating tape. No residue when removed. Starts fusing within minutes; fully bonded within hours. Excellent cold temperature performance. Low water absorption.
- Tested to:
  - ASTM D 149; provides minimum 400 V/mil. for .010" to .030" thick tape, 300 V/mil for .040" thick tape and 250 V/mil for .060" thick tape.
  - ASTM D 412; provides minimum 700 psi tensile strength and minimum 300% elongation.
  - ASTM D 2240; Durometer (Shore A); 55. Other test data available.
- Excellent for sealing ends of firesleeve: prevents sleeve from absorbing contamination and wicking liquids. Excellent for wrapping electrical & mechanical connections and splices. Makes clean and neat installations of cables, wires and hoses. Makes an instant separation bumper and provides vibration dampening.
- Meets Mil-I-46852, AA59163 and ABS 5334 specifications. Certificate of Conformity available.
- Cross Reference Equivalents Available to MOX 600R and 600T levelwrap series; 602-1, 603-1, 604-1, 605-1, 606-1, 607-1. McDonnell Douglas / Boeing DMS-2186 Type I & II, McDonnell Douglas Helicopter HS5215, General Dynamics P5384, Martin Marietta MMS 517-6 Type II, McDonnell Douglas P.S. 17115, ST0130RB0078 Type I, 3003M70P01, MS70T09-S, WS1363A, Premier Farnell 810112, Safe Flight 59562-5, PLYSIL3455, TYT200-1, 66N, 67N and various NATO / National Stock Numbers (NSN).
- Amalgamating time: Room temperature; 24 hours / at 120°C; 120 minutes / at 150°C; 35 minutes / at 200°C; 20 minutes / at 250°C; 15 minutes. Tested for short duration fluid resistance: Jet Fuel (JP5), Hydraulic Fluid (Skydrol 500B4), Mineral Oil (NATO 0142), Synthetic Oil (NATO 0156), MIL-C-87836 & Foran 141B cleaning fluids, MIL-A-8243 cooling fluid.

These tapes are guaranteed to meet specification for 1 year from date of manufacture providing tapes are stored dry at 21°C +/- 3°C or 70°F +/- 5°F. Standard tapes have an interleaved liner of polyethylene. Polyester liner available.

Type II tapes have a center guideline stripe to assist in making 50% overwraps. The triangular profile version tape allows for minimal ridge lines, providing wire and cable splices and joints with an almost totally smooth surface (prevents snagging when splice is pulled through obstructions).



**FlameShield™ MIL-I-46852 Specification  
 High Temperature Silicone Self Fusing  
 Compression/Stretch Electrical Insulating Tape**

**MIL-I-46852-1I0020 / MIL-I-46852-1I0020 / MIL-I-46852-1I0030 / MIL-I-46852-1I0030  
 MIL-I-46852-1I0040 / MIL-I-46852-1I0040**

**Class 1 – Type I and Class 1 - Type II**

Part Number	Tape Width Inches	Thickness inches	Color / Type / Profile	Price Per Roll
MIL-I-46852-1I0020-RXX-0.50	½"	0.020"	Black or Red / Type I / Rectangular	\$ 29.37
MIL-I-46852-1I0030-RXX-0.50	½"	0.030"	Black or Red / Type I / Rectangular	\$ 37.16
MIL-I-46852-1I0020-RXX-0.62	5/8"	0.020"	Black or Red / Type I / Rectangular	\$ 30.17
MIL-I-46852-1I0020-RXX-0.75	¾"	0.020"	Black or Red / Type I / Rectangular	\$ 31.96
MIL-I-46852-1I0010-RXX-1.00	1"	0.010"	Black or Red / Type I / Rectangular	\$ 29.37
MIL-I-46852-1I0020-TXX-1.00	1"	0.020"	Black or Red / Type II / Triangular	\$ 33.80
MIL-I-46852-1I0020-RXX-1.00	1"	0.020"	Black or Red / Type I / Rectangular	\$ 34.71
MIL-I-46852-1I0040-TXX-1.00	1"	0.040"	Black or Red / Type II / Triangular	\$ 37.91
MIL-I-46852-1I0040-RXX-1.00	1"	0.040"	Black or Red / Type I / Rectangular	\$ 39.64
MIL-I-46852-1I0020-RXX-1.50	1 ½"	0.020"	Black or Red / Type I / Rectangular	\$ 48.77
MIL-I-46852-1I0012-RXX-1.50	1 ½"	0.012"	Black or Red / Type I / Rectangular	\$ 38.47
MIL-I-46852-1I0020-RXX-2.00	2"	0.020"	Black or Red / Type I / Rectangular	\$ 57.13
MIL-I-46852-1I0020-TXX-2.00	2"	0.020"	Black or Red / Type II / Triangular	\$ 48.86

**Guideline Color on Type II Triangular Tapes Only:** .020" = blue / .030" = white / .040" = green  
 Type II edge thickness is .008" +/- .001"

**Please enquire for pricing on widths and thicknesses other than those listed above.**

- Standard roll length is 36 feet / 12 Yards / 10.9 Metres; other lengths available.
- For the XX value (color code): OR = Oxide-Red, BK = Black. Other colors available.
- Certificate of Conformity: Add \$6.00 for individual roll CofC. Lot/Batch CofC \$25.00 per order line item.
- Test Report: Add \$75.00 per order line item.

Amalgamating time: Room temperature; 24 hours / at 120°C; 120 minutes / at 150°C; 35 minutes / at 200°C; 20 minutes / at 250°C; 15 minutes. Tested for short duration fluid resistance: Jet Fuel (JP5), Hydraulic Fluid (Skydrol 500B4), Mineral Oil (NATO 0142), Synthetic Oil (NATO 0156), MIL-C-87836 & Foran 141B cleaning fluids, MIL-A-8243 cooling fluid.

These tapes are guaranteed to meet specification for 1 year from date of manufacture providing tapes are stored dry at 21°C +/- 3°C or 70°F +/- 5°F. Standard tapes have an interleaved liner of polyethylene. Polyester liner available.

## FlameShield™ MIL-I-46852 Specification Silicone Rubber Self Fusing Electrical Insulating Tape - Technical Data

<b>Specifications for FlameShield™ Silicone Rubber Tape meeting MIL-I-46852 Class 1 – Type I and Type II</b>			
<b>Property</b>	<b>Standard</b>	<b>Nominal Test Result or Tolerance</b>	<b>Test Method</b>
Thickness: 1" wide tape	.010" .020" .030" .040"	+/- .002"	N/A
Width	0.50", 0.625", 0.75", 1.00", 1.50", 2.00"	+/- .020"	N/A
Length	36 feet / 12 yards	+/- 6.00"	N/A
Color	Oxide-Red or Black	N/A	N/A
Guideline Color (Type II)	.020" Tapes: Blue .030" Tapes: White .040" Tapes: Green	N/A	N/A
Operating Temperature	-60°C to +260°C -76°C to +500°F	N/A	N/A
Brittle Temperature	-65°C / -85°F	N/A	N/A
Interleave Material	.002" thick Mylar	N/A	N/A
Tensile Strength	700 psi (minimum)	1100	ASTM D412 / D119
Dielectric Strength	.010" tape: 400 V/mil .020" tape: 400 V/mil .030" tape: 400 V/mil .040" tape: 300 V/mil	575	ASTM D-149
Dielectric Constant		2.94 @ 1Khz	ASTM D150
Volume Resistivity	1 x 10 <sup>14</sup> ohms/cm <sup>3</sup>	3 x 10 <sup>14</sup>	ASTM D149
Elongation	300% (minimum)	700	ASTM D412 / D119
Tear Strength	85 psi (minimum)	146	ASTM D624
Bond Strength (1" Width)	2 lbs (minimum)	5.5	ASTM D2148
Adhesion	Shall not unwind more than 1.0" after 3 minutes with 600g load	0.12"	ASTM D2148
Inclined Mandrel Tack Test (inch)		0.25	ASTM D2148
Water absorption (by wt)	3% Maximum	0.9%	FED-STD-601 Method 6251
Dissipation Factor		<0.0004 @ 1 KHz	ASTM D150
Hardness, durometer Shore A	55 - 65	55	ASTM D2148 / D2240
Flame Test		Pass	FAA 60 Sec Vertical

**AA59163-1I0010 / AA59163-1I0020 / AA59163-1I0030 / AA59163-1I0040**

**Class 1 - Type I**

**AA59163-1II0020 / AA59163-1II0030 / AA59163-1II0040**

**Class 1 - Type II**

**Silicone Rubber Self Fusing Electrical Insulating Tape**

**500°F / 260°C: FlameShield™ Self Binding / Self-Fusing / Self Amalgamating Tape - High Temperature, Heat & Flame Resistant**

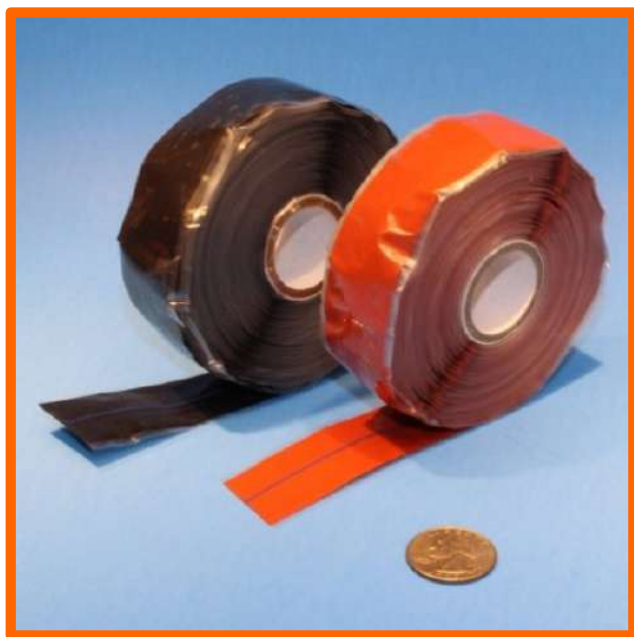

- Self-bonds / self fuses / self amalgamating tape. No residue when removed. Starts fusing within minutes; fully bonded within hours. Excellent cold temperature performance. Low water absorption.
- Tested to:
  - ASTM D 149; provides minimum 400 V/mil. for .010" to .030" thick tape, 300 V/mil for .040" thick tape and 250 V/mil for .060" thick tape.
  - ASTM D 412; provides minimum 700 psi tensile strength and minimum 300% elongation.
  - ASTM D 2240; Durometer (Shore A); 55. Other test data available.
- Excellent for sealing ends of firesleeve: prevents sleeve from absorbing contamination and wicking liquids. Excellent for wrapping electrical & mechanical connections and splices. Makes clean and neat installations of cables, wires and hoses. Makes an instant separation bumper and provides vibration dampening.
- Meets Mil-I-46852, AA59163 and ABS 5334 specifications. Certificate of Conformity available.
- Cross Reference Equivalents Available to MOX 600R and 600T levelwrap series; 602-1, 603-1, 604-1, 605-1, 606-1, 607-1. McDonnell Douglas / Boeing DMS-2186 Type I & II, McDonnell Douglas Helicopter HS5215, General Dynamics P5384, Martin Marietta MMS 517-6 Type II, McDonnell Douglas P.S. 17115, ST0130RB0078 Type I, 3003M70P01, MS70T09-S, WS1363A, Premier Farnell 810112, Safe Flight 59562-5, PLYSIL3455, TYT200-1, 66N, 67N and various NATO / National Stock Numbers (NSN).
- Amalgamating time: Room temperature; 24 hours / at 120°C; 120 minutes / at 150°C; 35 minutes / at 200°C; 20 minutes / at 250°C; 15 minutes. Tested for short duration fluid resistance: Jet Fuel (JP5), Hydraulic Fluid (Skydrol 500B4), Mineral Oil (NATO 0142), Synthetic Oil (NATO 0156), MIL-C-87836 & Foran 141B cleaning fluids, MIL-A-8243 cooling fluid.

These tapes are guaranteed to meet specification for 1 year from date of manufacture providing tapes are stored dry at 21°C +/- 3°C or 70°F +/- 5°F. Standard tapes have an interleaved liner of polyethylene. Polyester liner available.

Type II tapes have a center guideline stripe to assist in making 50% overwraps. The triangular profile version tape allows for minimal ridge lines, providing wire and cable splices and joints with an almost totally smooth surface (prevents snagging when splice is pulled through obstructions).

<b>FlameShield™ CID AA-59163 Specification</b> <b>High Temperature Silicone Self Fusing</b> <b>Compression/Stretch Electrical Insulating Tape</b> <b>AA59163-1I0020 / AA59163-1II0020 / AA59163-1I0030 / AA59163-1II0030</b> <b>AA59163-1I0040 / AA59163-1II0040</b> <b>Class 1 – Type I and Class 1 - Type II</b>				
Part Number	Tape Width Inches	Thickness inches	Color / Type / Profile	Single Roll Price Per Roll
AA59163-1I0020-RXX-0.50	½"	0.020"	Black or Red / Type I / Rectangular	\$ 29.37
AA59163-1I0030-RXX-0.50	½"	0.030"	Black or Red / Type I / Rectangular	\$ 37.16
AA59163-1I0020-RXX-0.62	5/8"	0.020"	Black or Red / Type I / Rectangular	\$ 30.17
AA59163-1I0020-RXX-0.75	¾"	0.020"	Black or Red / Type I / Rectangular	\$ 31.96
AA59163-1I0010-RXX-1.00	1"	0.010"	Black or Red / Type I / Rectangular	\$ 29.37
AA59163-1II0020-TXX-1.00	1"	0.020"	Black or Red / Type II / Triangular	\$ 33.80
AA59163-1I0020-RXX-1.00	1"	0.020"	Black or Red / Type I / Rectangular	\$ 34.71
AA59163-1II0040-TXX-1.00	1"	0.040"	Black or Red / Type II / Triangular	\$ 37.91
AA59163-1I0040-RXX-1.00	1"	0.040"	Black or Red / Type I / Rectangular	\$ 39.64
AA59163-1I0020-RXX-1.50	1 ½"	0.020"	Black or Red / Type I / Rectangular	\$ 48.77
AA59163-1I0012-RXX-1.50	1 ½"	0.012"	Black or Red / Type I / Rectangular	\$ 38.47
AA59163-1I0020-RXX-2.00	2"	0.020"	Black or Red / Type I / Rectangular	\$ 57.13
AA59163-1II0020-TXX-2.00	2"	0.020"	Black or Red / Type II / Triangular	\$ 48.86
<b>Guideline Color on Type II Triangular Tapes Only: .020" = blue / .030" = white / .040" = green</b> Type II edge thickness is .008" +/- .001"				

**Please enquire for pricing on widths and thicknesses other than those listed above.**

- Standard roll length is 36 feet / 12 Yards / 10.9 Metres; other lengths available.
- For the XX value (color code): OR = Oxide-Red, BK = Black. Other colors available.
- Certificate of Conformity: Add \$6.00 for individual roll CofC. Lot/Batch CofC \$25.00 per order line item.
- Test Report: Add \$75.00 per order line item.

Amalgamating time: Room temperature; 24 hours / at 120°C; 120 minutes / at 150°C; 35 minutes / at 200°C; 20 minutes / at 250°C; 15 minutes. Tested for short duration fluid resistance: Jet Fuel (JP5), Hydraulic Fluid (Skydrol 500B4), Mineral Oil (NATO 0142), Synthetic Oil (NATO 0156), MIL-C-87836 & Foran 141B cleaning fluids, MIL-A-8243 cooling fluid.

These tapes are guaranteed to meet specification for 1 year from date of manufacture providing tapes are stored dry at 21°C +/- 3°C or 70°F +/- 5°F. Standard tapes have an interleaved liner of polyethylene. Polyester liner available.

## FlameShield™ CID A-A-59163 Specification Silicone Rubber Self Fusing Electrical Insulating Tape - Technical Data

<b>Specifications for FlameShield™ Silicone Rubber Tape (MIL-I-46852 &amp; A-A-59163) Class 1 – Type I and Type II</b>			
<b>Property</b>	<b>Standard</b>	<b>Nominal Test Result or Tolerance</b>	<b>Test Method</b>
Thickness: 1" wide tape	.010" .020" .030" .040"	+/- .002"	N/A
Width	0.50", 0.625", 0.75", 1.00", 1.50", 2.00"	+/- .020"	N/A
Length	36 feet / 12 yards	+/- 6.00"	N/A
Color	Oxide-Red or Black	N/A	N/A
Guideline Color (Type II)	.020" Tapes: Blue .030" Tapes: White .040" Tapes: Green	N/A	N/A
Operating Temperature	-60°C to +260°C -76°C to +500°F	N/A	N/A
Brittle Temperature	-65°C / -85°F	N/A	N/A
Interleave Material	.002" thick Mylar	N/A	N/A
Tensile Strength	700 psi (minimum)	1100	ASTM D412 / D119
Dielectric Strength	.010" tape: 400 V/mil .020" tape: 400 V/mil .030" tape: 400 V/mil .040" tape: 300 V/mil	575	ASTM D-149
Dielectric Constant		2.94 @ 1Khz	ASTM D150
Volume Resistivity	1 x 10 <sup>14</sup> ohms/cm <sup>3</sup>	3 x 10 <sup>14</sup>	ASTM D149
Elongation	300% (minimum)	700	ASTM D412 / D119
Tear Strength	85 psi (minimum)	146	ASTM D624
Bond Strength (1" Width)	2 lbs (minimum)	5.5	ASTM D2148
Adhesion	Shall not unwind more than 1.0" after 3 minutes with 600g load	0.12"	ASTM D2148
Inclined Mandrel Tack Test (inch)		0.25	ASTM D2148
Water absorption (by wt)	3% Maximum	0.9%	FED-STD-601 Method 6251
Dissipation Factor		<0.0004 @ 1 KHz	ASTM D150
Hardness, durometer Shore A	55 - 65	55	ASTM D2148 / D2240
Flame Test		Pass	FAA 60 Sec Vertical



**AA59163-1I0010 / AA59163-1I0020 / AA59163-1I0020 / AA59163-1I0030  
AA59163-1I0030 / AA59163-1I0040 / AA59163-1I0040**

**Class 2 - Type IM and Class 2 - Type IIM**

**Silicone Rubber Self Fusing Electrical Insulating Tape**

500°F / 260°C: FlameShield™ Self Binding / Self-Fusing / Self Amalgamating Tape -

High Temperature, Heat & Flame Resistant



- Self-bonds / self fuses / self amalgamating tape. No residue when removed. Starts fusing within minutes; fully bonded within hours. Excellent cold temperature performance. Low water absorption.
- Tested to:
  - ASTM D 149; provides minimum 400 V/mil. for 0.250mm to 0.750mm thick tape, 300 V/mil for 1.000mm thick tape.
  - ASTM D 412; provides minimum 4800 kPa tensile strength and minimum 300% elongation.
  - ASTM D 2240; Durometer (Shore A); 55. Other test data available.
- Excellent for sealing ends of firesleeve: prevents sleeve from absorbing contamination and wicking liquids. Excellent for wrapping electrical & mechanical connections and splices. Makes clean and neat installations of cables, wires and hoses. Makes an instant separation bumper and provides vibration dampening.
- Meets Mil-I-46852, AA59163 and ABS 5334 specifications. Certificate of Conformity available.
- Cross Reference Equivalents Available to MOX 600R and 600T levelwrap series; 602-1, 603-1, 604-1, 605-1, 606-1, 607-1. McDonnell Douglas / Boeing DMS-2186 Type I & II, McDonnell Douglas Helicopter HS5215, General Dynamics P5384, Martin Marietta MMS 517-6 Type II, McDonnell Douglas P.S. 17115, ST0130RB0078 Type I, 3003M70P01, MS70T09-S, WS1363A, Premier Farnell 810112, Safe Flight 59562-5, PLYSIL3455, TYT200-1, 66N, 67N and various NATO / National Stock Numbers (NSN).
- Amalgamating time: Room temperature; 24 hours / at 120°C; 120 minutes / at 150°C; 35 minutes / at 200°C; 20 minutes / at 250°C; 15 minutes. Tested for short duration fluid resistance: Jet Fuel (JP5), Hydraulic Fluid (Skydrol 500B4), Mineral Oil (NATO 0142), Synthetic Oil (NATO 0156), MIL-C-87836 & Foran 141B cleaning fluids, MIL-A-8243 cooling fluid.



These tapes are guaranteed to meet specification for 1 year from date of manufacture providing tapes are stored dry at 21°C +/- 3°C or 70°F +/- 5°F. Standard tapes have an interleaved liner of polyethylene. Polyester liner available.

Type II tapes have a center guideline stripe to assist in making 50% overwraps. The triangular profile version tape allows for minimal ridge lines, providing wire and cable splices and joints with an almost totally smooth surface (prevents snagging when splice is pulled through obstructions).

## FlameShield™ CID AA-59163 Specification High Temperature Silicone Self Fusing Compression/Stretch Electrical Insulating Tape

**AA59163-1I0020 / AA59163-1II0020 / AA59163-1I0030 / AA59163-1II0030  
AA59163-1I0040 / AA59163-1II0040**

**Class 2 – Type IM and Class 2 - Type IIM**

Part Number	Tape Width mm	Thickness mm	Color / Type / Profile	Single Roll Price Per Roll
AA59163-2IM0500-RXX-13	13	0.500	Black or Red / Type IM / Rectangular	\$ 29.37
AA59163-2IM0750-RXX-13	13	0.750	Black or Red / Type IM / Rectangular	\$ 37.16
AA59163-2IM0500-RXX-15	15	0.500	Black or Red / Type IM / Rectangular	\$ 30.17
AA59163-2IM0500-RXX-20	20	0.500	Black or Red / Type IM / Rectangular	\$ 31.96
AA59163-2IM0250-RXX-25	25	0.250	Black or Red / Type IM / Rectangular	\$ 29.37
AA59163-2IIM0500-TXX-25	25	0.500	Black or Red / Type IIM / Triangular	\$ 33.80
AA59163-2IM0500-RXX-25	25	0.500	Black or Red / Type IM / Rectangular	\$ 34.71
AA59163-2IIM1000-TXX-25	25	1.000	Black or Red / Type IIM / Triangular	\$ 37.91
AA59163-2IM1000-RXX-25	25	1.000	Black or Red / Type IM / Rectangular	\$ 39.64
AA59163-2IM0500-RXX-38	38	0.500	Black or Red / Type IM / Rectangular	\$ 48.77
AA59163-2IM0300-RXX-38	38	0.300	Black or Red / Type IM / Rectangular	\$ 38.47
AA59163-2IM0500-RXX-50	50	0.500	Black or Red / Type IM / Rectangular	\$ 57.13
AA59163-2IIM0500-TXX-50	50	0.500	Black or Red / Type IIM / Triangular	\$ 48.86

**Guideline Color on Type IIM Triangular Tapes Only:** .500mm = blue / .750mm = white / 1.000mm = green

Type IIM edge thickness is 0.215mm +/- 0.015mm

**Please enquire for pricing on widths and thicknesses other than those listed above.**

- Standard roll length is 36 feet / 12 Yards / 10.9 Metres; other lengths available.
- For the XX value (color code): OR = Oxide-Red, BK = Black. Other colors available.
- Certificate of Conformity: Add \$6.00 for individual roll CoFC. Lot/Batch CoFC \$25.00 per order line item.
- Test Report: Add \$75.00 per order line item.

Amalgamating time: Room temperature; 24 hours / at 120°C; 120 minutes / at 150°C; 35 minutes / at 200°C; 20 minutes / at 250°C; 15 minutes. Tested for short duration fluid resistance: Jet Fuel (JP5), Hydraulic Fluid (Skydrol 500B4), Mineral Oil (NATO 0142), Synthetic Oil (NATO 0156), MIL-C-87836 & Foran 141B cleaning fluids, MIL-A-8243 cooling fluid.

These tapes are guaranteed to meet specification for 1 year from date of manufacture providing tapes are stored dry at 21°C +/- 3°C or 70°F +/- 5°F. Standard tapes have an interleaved liner of polyethylene. Polyester liner available.

## FlameShield™ CID AA-59163 Specification Silicone Rubber Self Fusing Electrical Insulating Tape - Technical Data

<b>Specifications for FlameShield™ Silicone Rubber Tape (MIL-I-46852 &amp; A-A-59163) Class 2 – Type IM and Type IIM</b>			
<b>Property</b>	<b>Standard</b>	<b>Nominal Test Result or Tolerance</b>	<b>Test Method</b>
Thickness: 1" wide tape	0.250mm 0.500mm 0.750mm 1.000mm	+/- .002"	N/A
Width	13mm, 19mm, 25mm, 38mm, 50mm	+/- .020"	N/A
Length	10.9m	+/- 120mm	N/A
Color	Oxide-Red or Black	N/A	N/A
Guideline Color (Type II)	0.500mm Tapes: Blue 0.750mm Tapes: White 1.000mm Tapes: Green	N/A	N/A
Operating Temperature	-60°C to +260°C -76°C to +500°F	N/A	N/A
Brittle Temperature	-65°C / -85°F	N/A	N/A
Interleave Material	.002" thick Mylar	N/A	N/A
Tensile Strength	4800 kPa (minimum)	7400	ASTM D412 / D119
Dielectric Strength	0.250mm tape: 400 V/mil 0.500mm tape: 400 V/mil 0.750mm tape: 400 V/mil 1.000mm tape: 300 V/mil	575	ASTM D-149
Dielectric Constant		2.94 @ 1Khz	ASTM D150
Volume Resistivity	1.7 x 10 <sup>14</sup> nanoohm metre	3 x 10 <sup>14</sup>	ASTM D149
Elongation	300% (minimum)	700	ASTM D412 / D119
Tear Strength	85 psi (minimum)	146	ASTM D624
Bond Strength (25mm Width)	0.9 kilogram-force	2.6	ASTM D2148
Adhesion	Shall not unwind more than 1.0" after 3 minutes with 600g load	0.12"	ASTM D2148
Inclined Mandrel Tack Test (inch)		0.25	ASTM D2148
Water absorption (by wt)	3% Maximum	0.9%	FED-STD-601 Method 6251
Dissipation Factor		<0.0004 @ 1 KHz	ASTM D150
Hardness, durometer Shore A	55 - 65	55	ASTM D2148 / D2240
Flame Test		Pass	FAA 60 Sec Vertical

## MIL-I-22444 Silicone Rubber Supported/Reinforced Self Fusing Limited Stretch Electrical Insulation Tape - Cable Splicing

500°F / 260°C: FlameShield™ Meets MIL-I-22444 and ASNA 5107 Specifications  
Self Binding Self-Fusing Tape - High Temperature, Heat & Flame Resistant



- Self-bonds / self fuses / self amalgamating. No sticky residue or adhesive when removed. Starts fusing within minutes, fully bonded within hours. Excellent cold weather and cryogenic performance.
- Excellent for sealing ends of firesleeve: protects sleeve from contamination and wicking liquids. Excellent for wrapping electrical & mechanical connections and splices. Makes clean and neat installations of cables, wires and hoses. Makes an instant separation bumper and provides vibration dampening. Secures insulation to hot air ducting.
- Meets Mil-i-22444 and ASNA 5107 specifications.
- Sinusoidal Fiberglass Reinforced with either 15% maximum stretch (SB15) or 25% maximum stretch (SA25) until failure of the reinforcement web.
- Specified for cable splicing by the US Navy.
- Used as a compression protection tape under wiring connector backshell clamping collars.
- CofC available.



The above picture of the clear version of the tape shows the fiberglass reinforcement layer. Tape is normally ordered in Oxide-Red or Black Color; other colors available including clear.

- Equivalent to MOX SA and MOX SB series tapes SB01020, SB00520, SB01015, SB01050 & SA00520, SA01020, SA03030, SA01015; DMS-2186 Type I, EMD/EMS 2074; General Dynamics P5189 & 5-00857; General Electric A50A493-C/D & A50E112; Grumman GT353V; RMS315 Type I; Simmonds 151274 (black); IBM 6084744; RL6000SA; RL6000SB; 68N, 69N, 78N, 79N; NSN 5970-01-325-8971; NSN 5970-00-841-1172; NSN 5970-14-464-7312; NSN 5970-01-596-7929

**MIL-I-22444 Silicone Rubber Supported/Reinforced Self Fusing Limited Stretch Electrical Insulation Tape - Cable Splicing (Continued)**

**500°F / 260°C: FlameShield™ Meets MIL-I-22444 and ASNA 5107 Specifications  
 Self Binding Self-Fusing Tape - High Temperature, Heat & Flame Resistant**



- "S25" tape is 25% limited elongation
- "S15" tape is 15% limited elongation

<b>FlameShield™ MIL Spec High Temperature Silicone Self Fusing Compression/Stretch Tape Meets MIL-I-22444 Type I</b>				
<b>Part Number</b>	<b>Tape Width Inches / mm</b>	<b>Thickness inches / mm</b>	<b>Type / Profile</b>	<b>Single Roll Price Per Roll</b>
MIL-I-22444-S25-M013-08-RXX-20	1/2 / 13	0.020 / 0.5	I / Rectangular	\$ 56.33
MIL-I-22444-S15-M013-08-RXX-20	1/2 / 13	0.020 / 0.5	I / Rectangular	\$ 56.33
MIL-I-22444-5970-00-446-8928-ROR*	1/2 / 13	0.020 / 0.5	I / Rectangular	\$ 99.24
MIL-I-22444-68N-5970-14-464-7312-ROR	3/4 / 19	0.012 / 0.3	I / Rectangular	\$ 61.37
MIL-I-22444-69N-RBK	3/4 / 19	0.020 / 0.5	I / Rectangular	\$ 64.82
MIL-I-22444-78N-ROR	1 / 25	0.020 / 0.5	I / Rectangular	\$ 67.29
MIL-I-22444-79N-RBK	1 / 25	0.020 / 0.5	I / Rectangular	\$ 67.29
MIL-I-22444-S25-M025-16-RXX-20	1 / 25	0.020 / 0.5	I / Rectangular	\$ 67.29
MIL-I-22444-S15-M025-16-RXX-20	1 / 25	0.020 / 0.5	I / Rectangular	\$ 67.29
MIL-I-22444-S25-M025-16-RXX-40	1 / 25	0.040 / 1.0	I / Rectangular	\$ 75.38

\*5970-00-446-8928 was originally specified at 0.018" thick but is no longer produced in that thickness. Replacement is MIL-I-22444-5970-00-446-8928-OR and is 0.020" thick.

**Please enquire for pricing on sizes other than those listed above.**

- Standard roll length is 36 feet / 12 Yards / 10.9 Metres. \* roll length 60 feet / 20 yards
- For the XX value (color code): OR = Oxide-Red, BK = Black. Clear & other colors available.
- Certificate of Conformity: Add \$6.00 for individual roll CofC. Lot/Batch CofC \$25.00 per order line item.
- Test Report: Add \$75.00 per order line item.

Amalgamating time: At 120°C; 120 minutes / at 150°C; 35 minutes / at 200°C; 20 minutes / at 250°C; 15 minutes

Tested for short duration fluid resistance: Jet Fuel (JP5), Hydraulic Fluid (Skydrol 500B4), Mineral Oil (NATO 0142), Synthetic Oil (NATO 0156), MIL-C-87836 & Foran 141B cleaning fluids, MIL-A-8243 cooling fluid.

These tapes are guaranteed to meet specification for 1 year from date of manufacture providing tapes are stored dry at 21°C +/- 3°C or 70°F +/- 5°F. Standard tapes have an interleaved liner of polyethylene. Polyester liner available.



**Boeing DMS 2186 Silicone Rubber Self Fusing Electrical Insulating Tape**  
**500°F / 260°C: FlameShield™ - Meets Boeing DMS 2186 Specifications – Available**  
**as DMS 2186 Type I & Type II**  
**Self Binding Self-Fusing Tape - High Temperature, Heat & Flame Resistant**

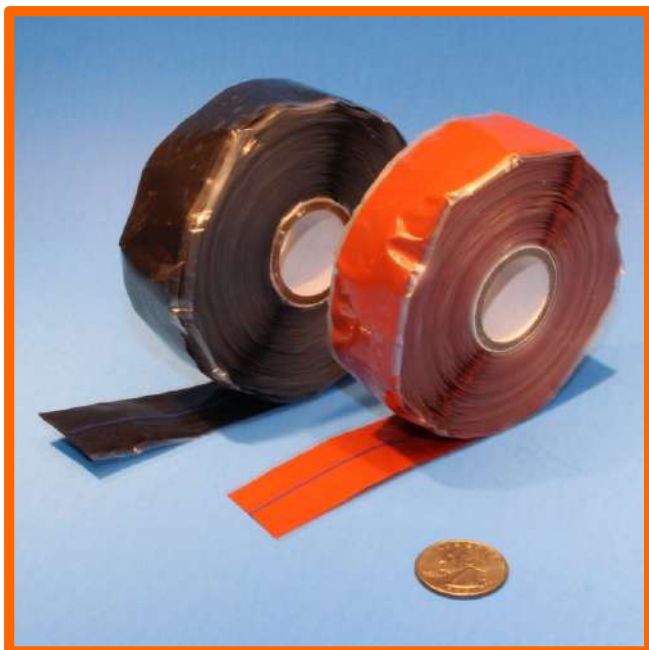

- Meets Boeing DMS2186 specifications.
- Self-bonds / self fuses / self amalgamating. No sticky residue or adhesive when removed. Starts fusing within minutes, fully bonded within hours. Excellent cold weather performance. Makes an excellent compression tape.
- Excellent for sealing ends of firesleeve: prevents sleeve from absorbing contamination and wicking liquids. Excellent for wrapping electrical & mechanical connections and splices. Makes clean and neat installations of cables, wires and hoses. Makes an instant separation bumper and provides vibration dampening.
- Type I meets MIL-I-22444 specifications. Type II meets Mil-I-46852, AA59163 and other proprietary specifications.
- Meets FAR 25.853 Appendix F, section a, 1, iv – Horizontal burn rate.
- CofC available.
- Available in Oxide-Red or Black.

FlameShield™ Boeing DMS 2186 Type I and Type II High Temperature Silicone Rubber Self Fusing Compression/Stretch Tape			
Part Number	Tape Width Inches / mm	Tape Thickness inches / mm	Single Roll Price
<b>BOEING DMS 2186 Type I (meets MIL-I-22444)</b>			
T-SR-BOEING-DMS2186-1S-0.75-20-XX	¾ / 19	0.020 / 0.51	\$ 63.96
T-SR-BOEING-DMS2186-1S-1.00-20-XX	1 / 25	0.020 / 0.51	\$ 88.96
<b>BOEING DMS 2186 Type II (meets MIL-I-46852 / AA-59163)</b>			
T-SR-BOEING-DMS2186-2-1.00-20-XX	1 / 25	0.020 / 0.51	\$ 45.46
T-SR-BOEING-DMS2186-2-1.00-30-XX	1 / 25	0.030 / 0.76	\$ 59.10
T-SR-BOEING-DMS2186-2-1.00-40-XX	1 / 25	0.040 / 1.01	\$ 72.97
T-SR-BOEING-DMS2186-2-1.25-50-XX	1 1/4 / 32	0.050 / 1.27	\$ 83.91
T-SR-BOEING-DMS2186-2-1.25-60-XX	1 1/2 / 38	0.060 / 1.52	\$ 96.74
T-SR-BOEING-DMS2186-2-1.25-80-XX	1 1/2 / 38	0.080 / 2.03	\$ 112.12

- Standard roll length is 36 feet / 12 Yards / 10.9 Metres; other lengths available.
- For the XX value (color code): OR = Oxide-Red, BK = Black
- DMS2186 specification does not allow tapes to be thinner than .020"

These tapes are guaranteed to meet specification for 1 year from date of manufacture providing tapes are stored dry at 21°C +/- 3°C or 70°F +/- 5°F. Recertification is available.

## Lockheed Martin Astronautics MMS J517 Type I & Type II Silicone Rubber Tape

**500°F / 260°C: FlameShield™ Self Fusing Electrical Insulating Tape**  
**Self Binding Self-Fusing Tape - High Temperature, Heat & Flame Resistant**

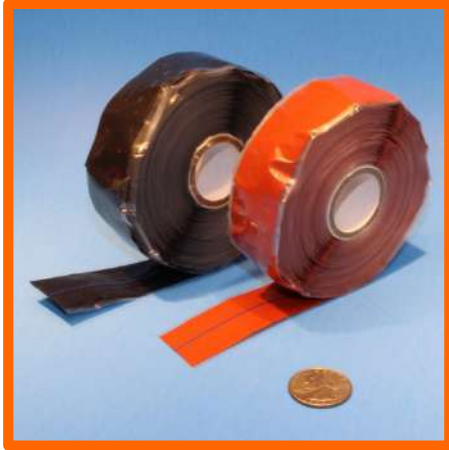

- Self-bonds / self fuses / self amalgamating. No sticky residue or adhesive when removed. Starts fusing within minutes, fully bonded within hours. Excellent cold weather performance. Makes an excellent compression tape.
- Excellent for sealing ends of firesleeve: prevents sleeve from absorbing contamination and wicking liquids. Excellent for wrapping electrical & mechanical connections and splices. Makes clean and neat installations of cables, wires and hoses. Makes an instant separation bumper and provides vibration dampening.
- Meets Mil-I-46852 and AA59163 and other specifications.
- CofC available.

### FlameShield™ High Temperature Silicone Rubber Self Fusing Compression/Stretch Electrical Insulating Tape – Meets MMS J517 Type I and Type II Specifications

Part Number	Tape Width Inches / mm	Tape Thickness inches / mm	Price Per Roll
<b>MMS J517 Type I</b>			
T-SR-MMSJ517-1-08-10	1/2 / 13	0.010 / 0.25	\$ 27.12
T-SR- MMSJ517-1-08-20	1/2 / 13	0.020 / 0.51	\$ 28.66
T-SR-MMSJ517-1-08-30	1/2 / 13	0.030 / 0.76	\$ 30.46
T-SR-MMSJ517-1-12-10	3/4 / 19	0.010 / 0.25	\$ 29.55
T-SR-MMSJ517-1-12-20	3/4 / 19	0.020 / 0.51	\$ 31.28
T-SR-MMSJ517-1-12-30	3/4 / 19	0.030 / 0.76	\$ 34.81
T-SR-MMSJ517-1-16-10	1 / 25	0.010 / 0.25	\$ 30.93
T-SR-MMSJ517-1-16-20	1 / 25	0.020 / 0.51	\$ 33.80
T-SR-MMSJ517-1-16-30	1 / 25	0.030 / 0.76	\$ 36.91
T-SR-MMSJ517-1-20-10	1.25 / 32	0.010 / 0.25	\$ 38.77
T-SR-MMSJ517-1-20-20	1.25 / 32	0.020 / 0.51	\$ 40.21
T-SR-MMSJ517-1-20-30	1.25 / 32	0.030 / 0.76	\$ 42.37
T-SR-MMSJ517-1-24-10	1.50 / 38	0.010 / 0.25	\$ 43.66
T-SR-MMSJ517-1-24-20	1.50 / 38	0.020 / 0.51	\$ 47.82
T-SR-MMSJ517-1-24-30	1.50 / 38	0.030 / 0.76	\$ 55.37
<b>MMS J517 Type II</b>			
T-SR-MMSJ517-2-16-20-XX	1 / 25	0.020 / 0.51	\$ 33.80
T-SR-MMSJ517-2-16-30-XX	1 / 25	0.030 / 0.76	\$ 42.88
T-SR-MMSJ517-2-16-40-XX	1 / 25	0.040 / 1.01	\$ 47.37
T-SR-MMSJ517-2-20-50-XX	1 1/4 / 32	0.050 / 1.27	\$ 53.91
T-SR-MMSJ517-2-24-60-XX	1 1/2 / 38	0.060 / 1.52	\$ 56.74
T-SR-MMSJ517-2-24-80-XX	1 1/2 / 38	0.080 / 2.03	\$ 63.12

- Standard roll length is 36 feet / 12 Yards / 10.9 Metres; other lengths available.
- For the XX value (color code): OR = Oxide-Red, BK = Black

These tapes are guaranteed to meet specification for 1 year from date of manufacture providing tapes are stored dry at 21°C +/- 3°C or 70°F +/- 5°F. Standard tapes have an interleaved liner of polyethylene. Polyester liner available.

**Lockheed Martin Space Systems 5-00857 & 5-00615 Silicone Tape**  
**500°F / 260°C: FlameShield™ Silicone Rubber Self Fusing Compression & Stretch**  
**Electrical Insulating Tape**  
**Self Binding Self-Fusing Tape - High Temperature, Heat & Flame Resistant**

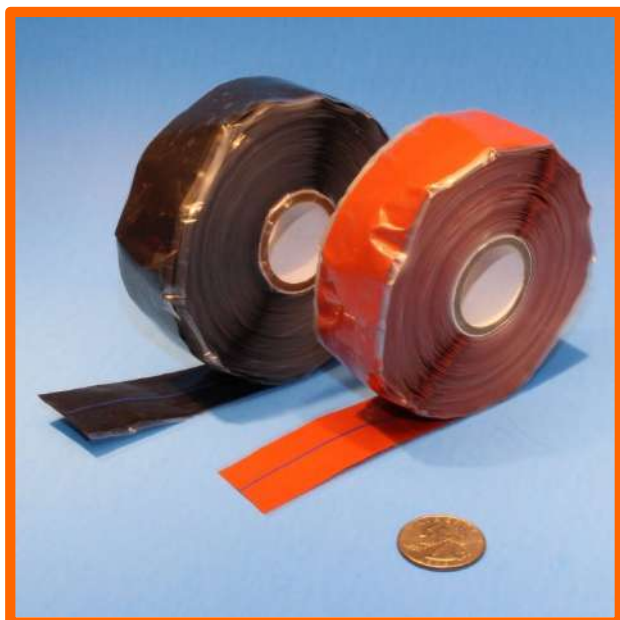

- Meets Lockheed-Martin 5-00857 & 5-00615 specifications.
- Self-bonds / self fuses / self amalgamating. No sticky residue or adhesive when removed. Starts fusing upon contact, fully bonded within hours. Excellent cold weather performance. Makes an excellent compression tape.
- Excellent for sealing ends of firesleeve: prevents sleeve from absorbing contamination and wicking liquids. Excellent for wrapping electrical & mechanical connections and splices. Makes clean and neat installations of cables, wires and hoses. Makes an instant separation bumper and provides vibration dampening.
- Meets MIL-I-22444, Mil-I-46852 and/or AA59163 and other proprietary specifications.
- CofC available.

<b>FlameShield™ High Temperature Silicone Rubber Self Fusing Compression/Stretch Tape Meets Lockheed Martin Space Systems 5-00857 &amp; 5-00615 Specifications</b>			
<b>Part Number</b>	<b>Tape Width Inches / mm</b>	<b>Tape Thickness inches / mm</b>	<b>Price Per Roll</b>
<b>Specification 5-00857</b>			
T-SR-5-00857-S-ZZ	As per specification	As per specification	\$ 67.29
<b>Specification 5-00615</b>			
T-SR-5-00615	As per specification	As per specification	\$ 34.71

- Standard roll length is 36 feet / 12 Yards / 10.9 Metres; other lengths available.
- For the ZZ value (color code): OR = Oxide-Red, BK = Black

These tapes are guaranteed to meet specification for 1 year from date of manufacture providing tapes are stored dry at 21°C +/- 3°C or 70°F +/- 5°F. Standard tapes have an interleaved liner of polyethylene. Polyester liner available.

**Lockheed Martin Tactical Systems P5189 Silicone Tape**  
**500°F / 260°C: FlameShield™ Silicone Rubber Self Fusing Compression & Stretch**  
**Electrical Insulating Tape**  
*Self Binding Self-Fusing Tape - High Temperature, Heat & Flame Resistant*



- Meets Lockheed-Martin Tactical Systems P5189 specifications.
- Self-bonds / self fuses / self amalgamating. No sticky residue or adhesive when removed. Starts fusing upon contact, fully bonded within hours. Excellent cold weather performance. Makes an excellent compression tape.
- Excellent for sealing ends of firesleeve: prevents sleeve from absorbing contamination and wicking liquids. Excellent for wrapping electrical & mechanical connections and splices. Makes clean and neat installations of cables, wires and hoses. Makes an instant separation bumper and provides vibration dampening.
- Meets MIL-I-22444 and other proprietary specifications.
- CofC available.

<b>FlameShield™ High Temperature Silicone Rubber Self Fusing                      Compression/Stretch Electrical Insulating Tape                      Meets Lockheed Martin Tactical Systems P5189 Specifications</b>			
Part Number	Tape Width Inches / mm	Tape Thickness inches / mm	Price Per Roll
<b>Specification P5189</b>			
T-SR-P5189-S-08	1/2 / 13	As per specification	\$ 35.81
T-SR-P5189-S-16	1 / 25	As per specification	\$ 46.43

- Standard roll length is 36 feet / 12 Yards / 10.9 Metres; other lengths available.

These tapes are guaranteed to meet specification for 1 year from date of manufacture providing tapes are stored dry at 21°C +/- 3°C or 70°F +/- 5°F. Standard tapes have an interleaved liner of polyethylene. Polyester liner available.

**Lockheed Martin Systems Integration 6084744 Silicone Rubber Tape**  
**500°F / 260°C: FlameShield™ Silicone Rubber Self Fusing Compression & Stretch**  
**Electrical Insulating Tape**  
*Self Binding Self-Fusing Tape - High Temperature, Heat & Flame Resistant*



- Self-bonds / self fuses / self amalgamating. No sticky residue or adhesive when removed. Starts fusing upon contact, fully bonded within hours. Excellent cold weather performance. Makes an excellent compression tape.
- Excellent for sealing ends of firesleeve: prevents sleeve from absorbing contamination and wicking liquids. Excellent for wrapping electrical & mechanical connections and splices. Makes clean and neat installations of cables, wires and hoses. Makes an instant separation bumper and provides vibration dampening.
- Meets Mil-I-22444 and other proprietary specifications.
- CofC available.
- NSN 5970-01-596-7929

FlameShield™ High Temperature Silicone Rubber Self Fusing Compression/Stretch Electrical Insulating Tape Meets Lockheed Martin Systems Integration 6084744 Specifications			
Part Number	Tape Width Inches / mm	Tape Thickness inches / mm	Price Per Roll
<b>Specification 6084744</b>			
T-SR-6084744-08-S15-XX	1/2 / 13	As per specification	\$ 56.33
T-SR-6084744-16-S15-XX	1 / 25	As per specification	\$ 67.29
T-SR-6084744-08-S25-XX (NSN 7970-01-596-7929)	1/2 / 13	As per specification	\$ 56.33
T-SR-6084744-16-S25-XX	1 / 25	As per specification	\$ 67.29

- Standard roll length is 36 feet / 12 Yards / 10.9 Metres; other lengths available.
- For the XX value (color code): OR = Oxide-Red, BK = Black

These tapes are guaranteed to meet specification for 1 year from date of manufacture providing tapes are stored dry at 21°C +/- 3°C or 70°F +/- 5°F. Standard tapes have an interleaved liner of polyethylene. Polyester liner available.



**General Dynamics P5384 Silicone Rubber Tape**  
**500°F / 260°C: FlameShield™ Silicone Rubber Self Fusing Compression & Stretch**  
**Electrical Insulating Tape**  
**Self Binding Self-Fusing Tape - High Temperature, Heat & Flame Resistant**



- Meets General Dynamics P5384 specifications.
- Self-bonds / self fuses / self amalgamating. No sticky residue or adhesive when removed. Starts fusing upon contact, fully bonded within hours. Excellent cold weather performance. Makes an excellent compression tape.
- Excellent for sealing ends of firesleeve: prevents sleeve from absorbing contamination and wicking liquids. Excellent for wrapping electrical & mechanical connections and splices. Makes clean and neat installations of cables, wires and hoses. Makes an instant separation bumper and provides vibration dampening.
- Meets Mil-I-46852 and AA59163 and other proprietary specifications.
- CofC available.

FlameShield™ High Temperature Silicone Rubber Self Fusing Compression/Stretch Electrical Insulating Tape Meets General Dynamics P5384 Specifications			
Part Number	Tape Width Inches / mm	Tape Thickness	Price Per Roll
T-SR-P5384	As per specification	As per specification	\$ 37.91

- Standard roll length is 36 feet / 12 Yards / 10.9 Metres; other lengths available.
- This tape is Black per the specification.

These tapes are guaranteed to meet specification for 1 year from date of manufacture providing tapes are stored dry at 21°C +/- 3°C or 70°F +/- 5°F. Standard tapes have an interleaved liner of polyethylene. Polyester liner available.

**Boeing HS5215E103 - NSN 5330-01-479-4233 Silicone Rubber Tape**  
**500°F / 260°C: FlameShield™ Silicone Rubber Self Fusing Compression & Stretch**  
**Electrical Insulating Tape**  
*Self Binding Self-Fusing Tape - High Temperature, Heat & Flame Resistant*



- Meets HS5215E103 specifications.
- Self-bonds / self fuses / self amalgamating. No sticky residue or adhesive when removed. Starts fusing upon contact, fully bonded within hours. Excellent cold weather performance. Makes an excellent compression tape.
- Excellent for sealing ends of firesleeve: prevents sleeve from absorbing contamination and wicking liquids. Excellent for wrapping electrical & mechanical connections and splices. Makes clean and neat installations of cables, wires and hoses. Makes an instant separation bumper and provides vibration dampening. Used as a backshell clamp bushing tape.
- Meets Mil-I-46852 and other proprietary specifications.
- CofC available.

FlameShield™ High Temperature Silicone Rubber Self Fusing Compression/Stretch Electrical Insulating Tape Meets HS5215E103 Specifications			
Part Number	Tape Width Inches / mm	Tape Thickness	Price Per Roll
T-SR-HS5215E103	As per specification	As per specification	\$ 38.17

- Standard roll length is 36 feet / 12 Yards / 10.9 Metres; other lengths available.
- This tape is Black per the specification.

These tapes are guaranteed to meet specification for 1 year from date of manufacture providing tapes are stored dry at 21°C +/- 3°C or 70°F +/- 5°F. Standard tapes have an interleaved liner of polyethylene. Polyester liner available.

**UL 94 V-0 Flamability Standards Silicone Tape**  
**400°F / 204°C: FlameShield™ Silicone Rubber Self Fusing Compression & Stretch**  
**Electrical Insulating Tape – Flame Retardant**  
*Self Binding Self-Fusing Tape - High Temperature, Heat & Flame Resistant*



- Produced with UL V-0 recognized flame retardant silicone rubber compound.
- Self-bonds / self fuses / self amalgamating. No sticky residue or adhesive when removed. Starts fusing upon contact, fully bonded within hours. Excellent cold weather performance. Makes an excellent compression tape.
- Excellent for sealing ends of firesleeve: prevents sleeve from absorbing contamination and wicking liquids. Excellent for wrapping electrical & mechanical connections and splices. Makes clean and neat installations of cables, wires and hoses. Makes an instant separation bumper and provides vibration dampening.
- Meets A-A-59163 and other proprietary specifications.
- -65°F / -51°C low temperature range.
- CofC available.
- Available in Brown or Black.

<b>FlameShield™ Flame Resistant High Temperature Silicone Self Fusing                      Compression/Stretch Electrical Insulating Tape</b> <b>Meets UL 94 V-0 Flame Test Standards and A-A-59163 Specifications</b>				
Part Number	Tape Width Inches / mm	Thickness inches / mm	Type / Profile	Single Roll Price Per Roll
T-SR-UL-16-RXX-10	1 / 25	0.010 / 0.25	I / Rectangular	\$ 34.80
T-SR-UL-16-RXX-20	1 / 25	0.020 / 0.51	I / Rectangular	\$ 41.71
T-SR-UL-16-RXX-30	1 / 25	0.030 / 0.76	I / Rectangular	\$ 49.67
T-SR-UL-16-RXX-40	1 / 25	0.040 / 1.02	I / Rectangular	\$ 62.91

- Standard roll length is 36 feet / 12 Yards / 10.9 Metres
- For the XX value (color code): BK = Black, BR = Brown

**Rockwell International ST0130RB0078 Silicone Rubber Tape**  
**500°F / 260°C: FlameShield™ Silicone Rubber Self Fusing Compression & Stretch**  
**Electrical Insulating Tape**  
*Self Binding Self-Fusing Tape - High Temperature, Heat & Flame Resistant*

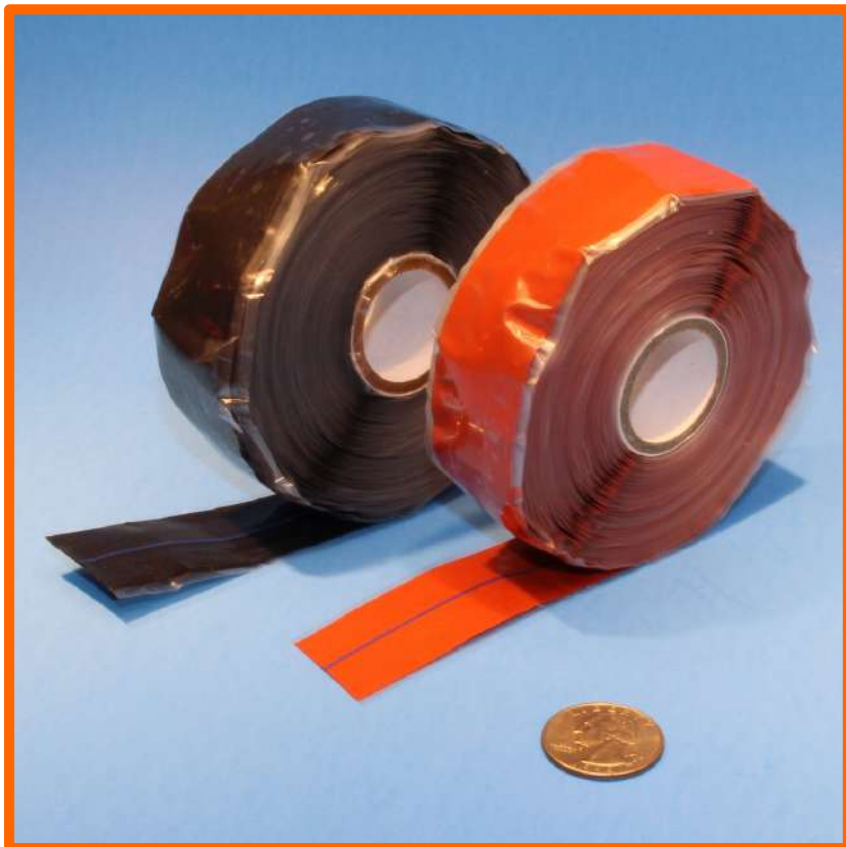

- Self-bonds / self fuses / self amalgamating. No sticky residue or adhesive when removed. Starts fusing within minutes, fully bonded within hours. Excellent cold weather performance. Makes an excellent compression tape.
- Excellent for sealing ends of firesleeve: prevents sleeve from absorbing contamination and wicking liquids. Excellent for wrapping electrical & mechanical connections and splices. Makes clean and neat installations of cables, wires and hoses. Makes an instant separation bumper and provides vibration dampening.
- Meets Mil-I-46852 and AA59163 and other proprietary specifications.
- CofC available.

<b>FlameShield™ Rockwell International ST0130RB0078 High Temperature Silicone Rubber Self Fusing Compression/Stretch Tape</b>			
<b>Part Number</b>	<b>Tape Width Inches / mm</b>	<b>Tape Thickness Inches / mm</b>	<b>Price Per Roll</b>
<b>ST0130RB0078 Type I Tape</b>			
T-SR-ST0130RB0078-1T	As per specification	As per specification	\$ 33.80
<b>ST0130RB0078 Type II Tape</b>			
T-SR-ST0130RB0078-2R-12	As per specification	0.012 / 0.30	\$ 30.47
T-SR-ST0130RB0078-2R-15	As per specification	0.015 / 0.38	\$ 32.88
T-SR-ST0130RB0078-2R-20	As per specification	0.020 / 0.51	\$ 34.71

- Standard roll length is 36 feet / 12 Yards / 10.9 Metres; other lengths available.
- All versions of ST0130RB0078 are Oxide-Red

These tapes are guaranteed to meet specification for 1 year from date of manufacture providing tapes are stored dry at 21°C +/- 3°C or 70°F +/- 5°F. Standard tapes have an interleaved liner of polyethylene. Polyester liner available.

**General Electric Power Generation A50A493 & 3003M70P Silicone Rubber Tape**  
**500°F / 260°C: FlameShield™ Silicone Rubber Self Fusing Compression & Stretch Electrical Insulating Tape**  
**Self Binding Self-Fusing Tape - High Temperature, Heat & Flame Resistant**



- Self-bonds / self fuses / self amalgamating. No sticky residue or adhesive when removed. Starts fusing within minutes, fully bonded within hours. Excellent cold weather performance. Makes an excellent compression tape.
- Excellent for sealing ends of firesleeve: prevents sleeve from absorbing contamination and wicking liquids. Excellent for wrapping electrical & mechanical connections and splices. Makes clean and neat installations of cables, wires and hoses. Makes an instant separation bumper and provides vibration dampening.
- Meets Mil-I-46852 and AA59163 and other proprietary specifications.
- CofC available.

<b>FlameShield™ General Electric Power Generation Standard A50A493 &amp; 3003M70 High Temperature Silicone Rubber Self Fusing Compression/Stretch Tape</b>			
<b>Part Number</b>	<b>Tape Width Inches / mm</b>	<b>Tape Thickness Inches / mm</b>	<b>Price Per Roll</b>
<b>A50A493A Tape:</b>			
T-SR-GEPG-93A-T-16-20	1 / 25	0.020 / 0.51	\$ 33.80
<b>A50A493B Tape:</b>			
T-SR-GEPG-93B-T-16-40	1 / 25	0.040 / 1.02	\$ 37.91
<b>A50A493C Tape:</b>			
T-SR-GEPG-93C-R-16-20	1 / 25	0.020 / 0.51	\$ 46.43
<b>A50A493D Tape:</b>			
T-SR-GEPG-93D-R-48-30	3 / 76	0.030 / 0.76	\$ 104.87
<b>3003M70P01 Tape:</b>			
T-SR-GEPG-P01-T-16-20	1 / 25	0.020 / 0.51	\$ 33.80
<b>3003M70P02 Tape:</b>			
T-SR-GEPG-P02-R-12-20	3/4 / 19	0.020 / 0.51	\$ 31.96
<b>3003M70P03 Tape:</b>			
T-SR-GEPG-P03-R-08-20	1/2 / 13	0.020 / 0.51	\$ 29.37
<b>3003M70P04 Tape:</b>			
T-SR-GEPG-P04-R-24-60	3 / 76	0.060 / 1.52	\$ 48.77

- Standard roll length is 36 feet / 12 Yards / 10.9 Metres; other lengths available.
- All versions of A50A493 are Oxide-Red



## General Electric Transportation Systems A50E112 & EMS2074 Silicone Rubber Tape

500°F / 260°C: FlameShield™ Silicone Rubber Self Fusing Compression & Stretch Electrical Insulating Tape

*Self Binding Self-Fusing Tape - High Temperature, Heat & Flame Resistant*



- Self-bonds / self fuses / self amalgamating. No sticky residue or adhesive when removed. Starts fusing within minutes, fully bonded within hours. Excellent cold weather performance. Makes an excellent compression tape.
- Excellent for sealing ends of firesleeve: prevents sleeve from absorbing contamination and wicking liquids. Excellent for wrapping electrical & mechanical connections and splices. Makes clean and neat installations of cables, wires and hoses. Makes an instant separation bumper and provides vibration dampening.
- Meets Mil-I-46852 and AA59163 and other proprietary specifications.
- CofC available.

FlameShield™ General Electric Transportation Systems Standard A50E112 & EMS2074 – Junction Insulation Tape High Temperature Silicone Rubber Self Fusing Compression/Stretch Tape			
Part Number	Tape Width Inches / mm	Tape Thickness Inches / mm	Price Per Roll
<b>A50E112 Tape &amp; 8355873 Tape</b>			
T-SR-GETS-R-S-16-20	1 / 25	0.020 / 0.51	\$ 33.80
<b>A50E112 Tape &amp; 8355873 Tape High Strength Version</b>			
T-SR-GETS-R-16-30HS	1 / 25	0.030 / 1.02	\$ 44.91

- Standard roll length is 36 feet / 12 Yards / 10.9 Metres; other lengths available.
- Tapes are Oxide-Red
- Standard version is 1362 psi / High Strength version is 1500 psi

These tapes are guaranteed to meet specification for 1 year from date of manufacture providing tapes are stored dry at 21°C +/- 3°C or 70°F +/- 5°F. Standard tapes have an interleaved liner of polyethylene. Polyester liner available.

**Rohr RMS315 Silicone Rubber Tape**  
**500°F / 260°C: FlameShield™ Silicone Rubber Self Fusing Compression & Stretch**  
**Electrical Insulating Tape**  
**Self Binding Self-Fusing Tape - High Temperature, Heat & Flame Resistant**



- Self-bonds / self fuses / self amalgamating. No sticky residue or adhesive when removed. Starts fusing within minutes, fully bonded within hours. Excellent cold weather performance. Makes an excellent compression tape.
- Excellent for sealing ends of firesleeve: prevents sleeve from absorbing contamination and wicking liquids. Excellent for wrapping electrical & mechanical connections and splices. Makes clean and neat installations of cables, wires and hoses. Makes an instant separation bumper and provides vibration dampening.
- Meets Mil-I-46852 and AA59163 and other proprietary specifications.
- Meets FAR 25.853 Appendix F, section a, 1, iv – Horizontal burn rate.
- CofC available.

<b>FlameShield™ Rohr RMS315 Tape</b>			
<b>High Temperature Silicone Rubber Self Fusing Compression/Stretch Tape</b>			
<b>Part Number</b>	<b>Tape Width Inches / mm</b>	<b>Tape Thickness Inches / mm</b>	<b>Price Per Roll</b>
<b>Rohr RMS315 Type I Tape</b>			
T-SR-RMS315-1RS-08-20-XX	1/2 / 13	As per specification	\$ 47.76
T-SR-RMS315-1RS-16-12-XX	1 / 25	As per specification	\$ 64.29
T-SR-RMS315-1RS-20-20-XX	1.25 / 32	As per specification	\$ 67.96
<b>Rohr RMS315 Type II Tape</b>			
T-SR-RMS315-2T-20-XX	As per specification	0.020 / 0.51	\$ 33.80
T-SR-RMS315-2T-30-XX	As per specification	0.030 / 0.76	\$ 35.71
T-SR-RMS315-2T-A-40-XX	As per specification	0.040 / 1.01	\$ 37.33
T-SR-RMS315-2T-B-40-XX	As per specification	0.040 / 1.01	\$ 42.87
T-SR-RMS315-2T-A-50-XX	As per specification	0.050 / 1.27	\$ 44.63
T-SR-RMS315-2T-B-50-XX	As per specification	0.050 / 1.27	\$ 47.37
T-SR-RMS315-2T-60-XX	As per specification	0.060 / 1.52	\$ 49.88
T-SR-RMS315-2T-70-XX	As per specification	0.070 / 1.78	\$ 52.67
<b>Rohr RMS315 Type III Tape</b>			
T-SR-RMS315-3R	As per specification	As per specification	\$ 35.62

- Standard roll length is 36 feet / 12 Yards / 10.9 Metres; other lengths available.
- For the XX value (color code): OR = Oxide-Red, BK = Black

**Garmin 249-00114-00 Silicone Rubber Tape**  
**500°F / 260°C: FlameShield™ Silicone Rubber Self Fusing Compression & Stretch**  
**Electrical Insulating Tape**  
*High Temperature, Heat & Flame Resistant*



- Garmin 249-00114-00 tape is available in oxide-red and black colors.
- Self-bonds / self fuses / self amalgamating. No sticky residue or adhesive when removed. Starts fusing upon contact, fully bonded within hours. Excellent cold weather performance. Makes an excellent compression tape.
- Used to protect wiring at the backshell clamp from clamping damage. Also provides equalization of strain relief.
- Used to build up the diameter of the wire bundle so that the cable clamp on the backshell will hold the wires in situations where too few wires would have resulted in the clamp not contacting the wires, resulting in strain on the connector's internal pins.
- Meets Mil-I-46852 / AA59163 and other specifications. CofC available.

FlameShield™ High Temperature Silicone Rubber Self Fusing Compression/Stretch Tape Garmin 249-00114-00			
Part Number	Tape Width and Thickness Inches / mm	Color	Price Per Roll
T-SR-Garmin-249-00114-OR	As per Garmin specification	Oxide-Red	\$ 33.64
T-SR-Garmin-249-00114-BK	As per Garmin specification	Black	\$ 33.64





## Amphenol ITT Canon Connector Backshell Strain Relief Isolation Tape

### 500°F / 260°C: FlameShield™ Silicone Rubber Isolation Tape

High Temperature, Heat & Flame Resistant

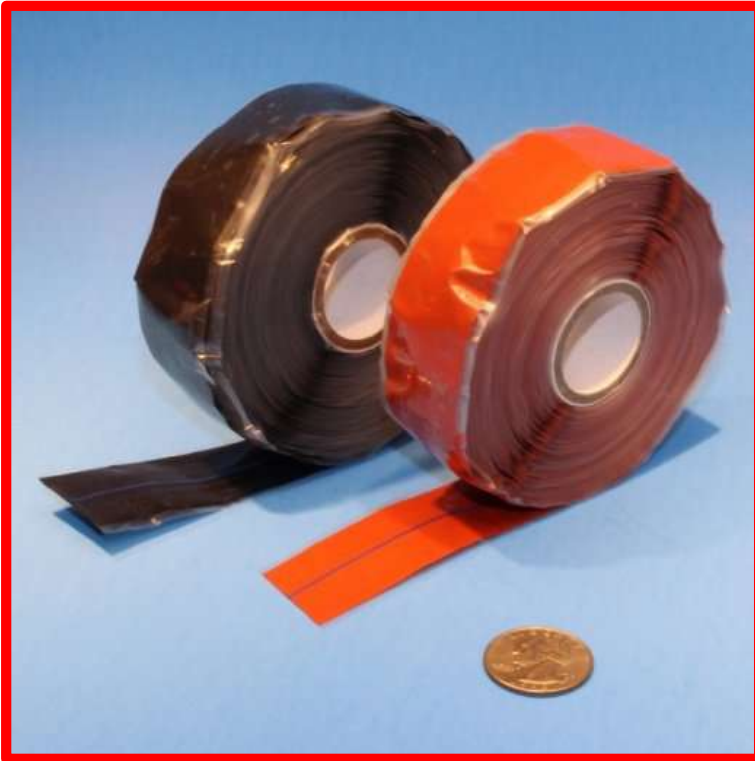

- Available as Type I unsupported (rectangular end profile), Type II unsupported (triangular end profile). Both Types meeting Mil-I-46852 / AA59163 specifications.
- Also available as supported meeting Mil-I-22444 (rectangular end profile).
- Suitable for all Amphenol / ITT / Canon round and flat backshell strain relief clamps.
- Equivalent to Garmin 249-00114-00 tape for aviation use.
- Self-bonds / self fuses / self amalgamating. No sticky residue or adhesive when removed. Starts fusing upon contact, fully bonded within hours. Excellent cold weather performance. Makes an excellent compression tape. Used to protect wiring at the backshell clamp from clamping damage. Also provides equalization of strain relief.
- Used to build up the diameter of the wire bundle so that the cable clamp on the backshell will hold the wires in situations where too few wires would have resulted in the clamp not contacting the wires, resulting in strain on the connector's internal pins.
- Available as Class 1 Type I and Type II or Class 2 tape Type I and Type II. (Class 1 is inch-pound specification, Class 2 is millimetre-kg specification)
- Available in Oxide-Red and Black.
- Standard tape thickness includes .020", .030" and .040".
- Standard widths include 0.500", 0.625", 0.750", 1.000", 1.500", 2.000".
- C of C available.

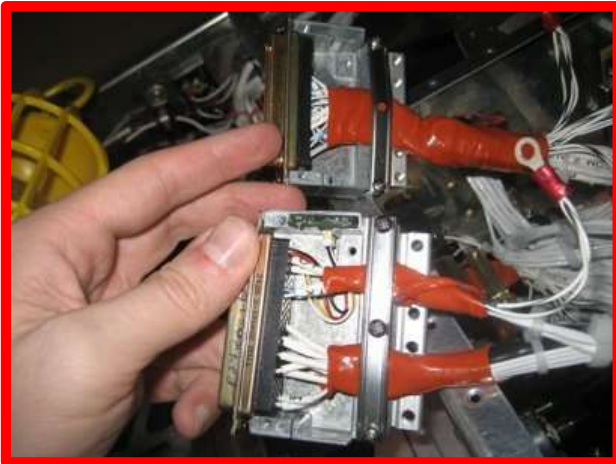

Type I unsupported tape is rectangular in end profile view. It is preferred for making custom bushings, vibration dampners, etc. Type II unsupported tape is triangular in end profile view. It is particularly suitable for wrapping splices, wiring bundles and cables as it forms a smoother surface and minimizes snagging if pulling wiring through bundles. Type I and Type II meet MIL-I-46852 and AA-59163 specifications. Unsupported tape means that there is no fiberglass interweave layer inside the tape, which is used to limit the ultimate elongation of the tape when it is stretched during installation.

The supported version of the tape is rectangular in end profile view (it looks like Type I tape), and includes a fiberglass reinforcement layer to limit the amount of stretch (elongation) that the tape can undergo (which limits how thin the tape results in being after stretching), prevents migration of the silicone under high clamping forces or around high angle bends or sharp corners. Supported tapes meet MIL-I-22444 specification.

MIL-I-46852 and AA-59163 specifications are very similar to MIL-I-22444 specifications, with the exception of the elongation values - which are lower in tapes meeting MIL-I-22444 due to the fiberglass supporting layer.

**Amphenol ITT CanonConnector Backshell Strain Relief Isolation Tape/Bushing**  
**500°F / 260°C: FlameShield™ Silicone Rubber Isolation Tape**  
*High Temperature, Heat & Flame Resistant*



<b>Amphenol ITT Canon Connector Backshell Strain Relief Isolation Tape</b> <b>Meets MIL-I-46852 / A-A-59163 / ABS 5334 Specifications - Type I and Type II Version</b> <b>MIL-I-22444 Supported Version</b>				
Part Number	Tape Width Inches / mm	Thickness inches / mm	Color / Type / Profile	Single Roll Price Per Roll
<b>Unsupported MIL-I-46852 / AA-59163 Type I and Type II tapes below</b>				
T-SR-AMPHENOL-08-RXX-20	1/2 / 12.7	0.020 / 0.508	Black or Red / I / Rectangular	\$ 29.37
T-SR-AMPHENOL-08-RXX-30	1/2 / 12.7	0.030 / 0.760	Black or Red / I / Rectangular	\$ 37.16
T-SR-AMPHENOL-10-RXX-20	5/8 / 15.7	0.020 / 0.508	Black or Red / I / Rectangular	\$ 30.17
T-SR-AMPHENOL-12-RXX-20	3/4 / 19	0.020 / 0.508	Black or Red / I / Rectangular	\$ 31.96
T-SR-AMPHENOL-16-RXX-10	1 / 25.4	0.010 / 0.254	Black or Red / I / Rectangular	\$ 29.37
T-SR-AMPHENOL-16-TXX-20	1 / 25.4	0.020 / 0.508	Black or Red / II / Triangular	\$ 33.80
T-SR-AMPHENOL-16-RXX-20	1 / 25.4	0.020 / 0.508	Black or Red / I / Rectangular	\$ 34.71
T-SR-AMPHENOL-16-TXX-40	1 / 25.4	0.040 / 1.000	Black or Red / II / Triangular	\$ 37.91
T-SR-AMPHENOL-16-RXX-40	1 / 25.4	0.040 / 1.000	Black or Red / I / Rectangular	\$ 39.64
T-SR-AMPHENOL-24-RXX-20	1 ½ / 38.1	0.020 / 0.508	Black or Red / I / Rectangular	\$ 48.77
T-SR-AMPHENOL-24-RXX-12	1 ½ / 38.1	0.012 / 0.304	Black or Red / I / Rectangular	\$ 38.47
On the above tapes that are Type II, the guideline color is: blue on .020" thick tapes / white on .030" thick tapes / green on .040" thick tapes				
<b>Supported MIL-I-22444 tapes below</b>				
T-SR-AMPHENOL-16-S25XX-20	1 / 25.4	0.020 / 0.508	Black or Red	\$ 67.29
T-SR-AMPHENOL-16-S25XX-40	1 / 25.4	0.040 / 1.01	Black or Red	\$ 72.97

- Standard roll length is 36 feet / 12 Yards / 10.9 Metres; other lengths available.
- For the X value (color code): OR = Oxide-Red, BK = Black



## PEI-Genesis™ Connector Backshell Strain Relief Isolation Tape

### 500°F / 260°C: FlameShield™ Silicone Rubber Isolation Tape

High Temperature, Heat & Flame Resistant



- Available as Type I unsupported (rectangular end profile), Type II unsupported (triangular end profile). Both Types meeting Mil-I-46852 / AA59163 specifications.
- Also available as supported meeting Mil-I-22444 (rectangular end profile).
- Suitable for all Amphenol / ITT / Canon round and flat backshell strain relief clamps.
- Equivalent to Garmin 249-00114-00 tape for aviation use.
- Self-bonds / self fuses / self amalgamating. No sticky residue or adhesive when removed. Starts fusing upon contact, fully bonded within hours. Excellent cold weather performance. Makes an excellent compression tape. Used to protect wiring at the backshell clamp from clamping damage. Also provides equalization of strain relief.
- Used to build up the diameter of the wire bundle so that the cable clamp on the backshell will hold the wires in situations where too few wires would have resulted in the clamp not contacting the wires, resulting in strain on the connector's internal pins.
- Available as Class 1 Type I and Type II or Class 2 tape Type I and Type II. (Class 1 is inch-pound specification, Class 2 is millimetre-kg specification)
- Available in Oxide-Red and Black.
- Standard tape thickness includes .020", .030" and .040".
- Standard widths include 0.5", 0.75", 1.00", 1.50", 2.00".
- Manufacturer C of C available.

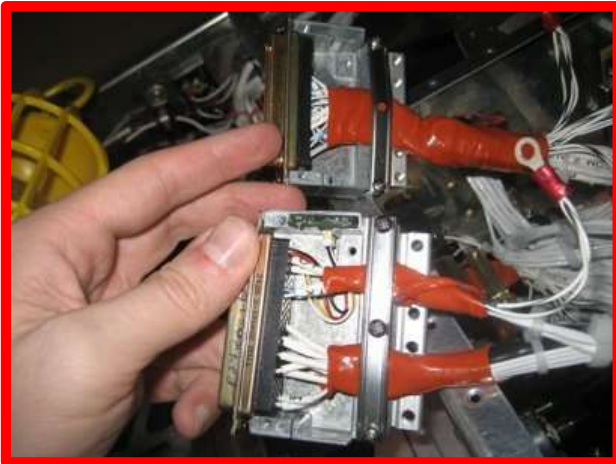

Type I unsupported tape is rectangular in end profile view. It is preferred for making custom bushings, vibration dampers, etc. Type II unsupported tape is triangular in end profile view. It is particularly suitable for wrapping splices, wiring bundles and cables as it forms a smoother surface and minimizes snagging if pulling wiring through bundles. Type I and Type II meet MIL-I-46852 and AA-59163 specifications. Unsupported tape means that there is no fiberglass interweave layer inside the tape, which is used to limit the ultimate elongation of the tape when it is stretched during installation.

The supported version of the tape is rectangular in end profile view (it looks like Type I tape), and includes a fiberglass reinforcement layer to limit the amount of stretch (elongation) that the tape can undergo (which limits how thin the tape results in being after stretching), prevents migration of the silicone under high clamping forces or around high angle bends or sharp corners. Supported tapes meet MIL-I-22444 specification.

MIL-I-46852 and AA-59163 specifications are very similar to MIL-I-22444 specifications, with the exception of the elongation values - which are lower in tapes meeting MIL-I-22444 due to the fiberglass supporting layer.

**PEI-Genesis™ Connector Backshell Strain Relief Isolation Tape/Bushing**  
**500°F / 260°C: FlameShield™ Silicone Rubber Isolation Tape**  
**High Temperature, Heat & Flame Resistant**



<b>PEI-Genesis™ Connector Backshell Strain Relief Isolation Tape</b> <b>Meets MIL-I-46852 / A-A-59163 / ABS 5334 Specifications - Type I and Type II Version</b> <b>MIL-I-22444 Supported Version</b>				
Part Number	Tape Width Inches / mm	Thickness inches / mm	Color / Type / Profile	Single Roll Price Per Roll
<b>Unsupported MIL-I-46852 / AA-59163 Type I and Type II tapes below</b>				
T-SR-PEI-GENESIS-08-RBK-20	1/2 / 12.7	0.020 / 0.508	Black / I / Rectangular	\$ 29.37
T-SR-PEI-GENESIS-08-RXX-30	1/2 / 12.7	0.030 / 0.760	Black or Red / I / Rectangular	\$ 37.16
T-SR-PEI-GENESIS-10-RBK-20	5/8 / 15.7	0.020 / 0.508	Black / I / Rectangular	\$ 30.17
T-SR-PEI-GENESIS-12-RBK-20	3/4 / 19	0.020 / 0.508	Black / I / Rectangular	\$ 31.96
T-SR-PEI-GENESIS-16-TXX-20	1 / 25.4	0.020 / 0.508	Black or Red / II / Triangular	\$ 33.80
T-SR-PEI-GENESIS-16-RXX-20	1 / 25.4	0.020 / 0.508	Black or Red / I / Rectangular	\$ 34.71
T-SR-PEI-GENESIS-16-TXX-40	1 / 25.4	0.040 / 1.000	Black or Red / II / Triangular	\$ 37.91
T-SR-PEI-GENESIS-16-RXX-40	1 / 25.4	0.040 / 1.000	Black or Red / I / Rectangular	\$ 39.64
T-SR-PEI-GENESIS-24-RXX-20	1 ½ / 38.1	0.020 / 0.508	Black or Red / I / Rectangular	\$ 48.77
T-SR-PEI-GENESIS-24-RXX-12	1 ½ / 38.1	0.012 / 0.304	Black or Red / I / Rectangular	\$ 38.47
On the above tapes that are Type II, the guideline color is: blue on .020" thick tapes / white on .030" thick tapes / green on .040" thick tapes				
<b>Supported MIL-I-22444 tapes below</b>				
T-SR-PEI-GENESIS-16-S25XX-20	1 / 25.4	0.020 / 0.508	Black or Red	\$ 67.29
T-SR-PEI-GENESIS-16-S25XX-40	1 / 25.4	0.040 / 1.01	Black or Red	\$ 72.97

- Standard roll length is 36 feet / 12 Yards / 10.9 Metres; other lengths available.
- For the XX value (color code): OR = Oxide-Red, BK = Black

**Thomas&Betts Equivalent Self-Fusing Insulation Tape**  
**500°F / 260°C: FlameShield™ Silicone Rubber Isolation Tape**  
*High Temperature, Heat & Flame Resistant*

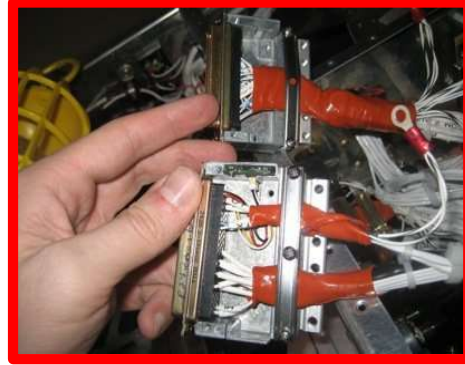
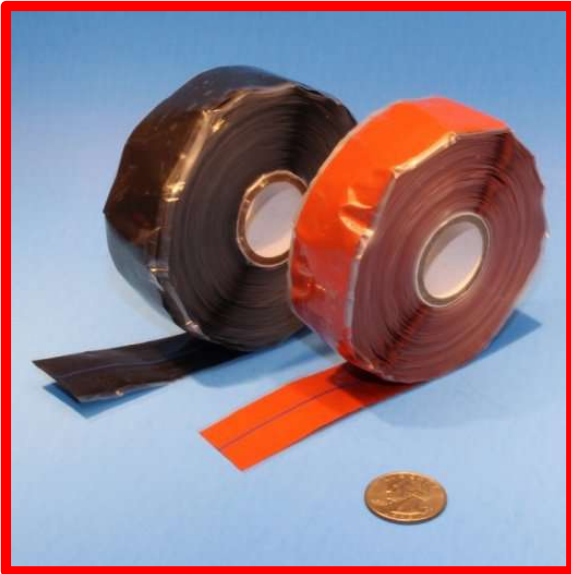

- Equivalent to TBFT201-36 & TBFT421-36 tape.
- Self-bonds / self fuses / self amalgamating. No sticky residue or adhesive when removed. Starts fusing upon contact, fully bonded within hours. Excellent cold weather performance. Makes an excellent compression tape. Used to protect wiring at the backshell clamp from clamping damage. Also provides equalization of strain relief.
- Used to build up the diameter of the wire bundle so that the cable clamp on the backshell will hold the wires in situations where too few wires would have resulted in the clamp not contacting the wires, resulting in strain on the connector's internal pins.
- Meets all Mil-I-46852 / A-A-59163 and other proprietary electrical and mechanical specifications. CofC available.

<b>Thomas&amp;Betts Equivalent Self-Fusing Insulation Tape</b>				
<b>Meets MIL-I-46852 / A-A-59163 / ABS 5334 Specifications - Type I and Type II</b>				
<b>Part Number</b>	<b>Tape Width Inches / mm</b>	<b>Thickness inches / mm</b>	<b>Colour / Type / Profile</b>	<b>Single Roll Price Per Roll</b>
T-SR-TBFT201-36-R	1 / 25.4	0.020 / 0.51	Red / II / Triangular	\$ 33.80
T-SR-TBFT201-36-B	1 / 25.4	0.020 / 0.51	Black / II / Triangular	\$ 33.80
T-SR-TBFT421-36-R	1 / 25.4	0.040 / 1.02	Red / II / Triangular	\$ 51.38
T-SR-TBFT421-36-B	1 / 25.4	0.040 / 1.02	Black / II / Triangular	\$ 51.38

- Standard roll length is 36 feet / 12 Yards / 10.9 Metres; other lengths available.

## Tyco Electronics TE Connectivity 608036 Equivalent Silicone Fusion Tape

500°F / 260°C: FlameShield™ Silicone Rubber Isolation Tape  
High Temperature, Heat & Flame Resistant

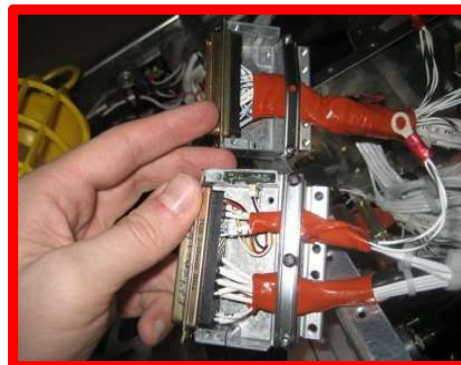

- Equivalent to TYCO Electronics TE Connectivity 608036 tape.
- Self-bonds / self fuses / self amalgamating. No sticky residue or adhesive when removed. Starts fusing upon contact, fully bonded within hours. Excellent cold weather performance. Makes an excellent compression tape. Used to protect wiring at the backshell clamp from clamping damage. Also provides equalization of strain relief.
- Used to build up the diameter of the wire bundle so that the cable clamp on the backshell will hold the wires in situations where too few wires would have resulted in the clamp not contacting the wires, resulting in strain on the connector's internal pins.
- Meets all Mil-I-46852 / AA59163 and other proprietary electrical and mechanical specifications. CofC available.

Tyco Electronics TE Connectivity Equivalent 608036 Silicone Fusion Tape Meets MIL-I-46852 / A-A-59163 / ABS 5334 Specifications - Type I and Type II				
Part Number	Tape Width Inches / mm	Thickness inches / mm	Colour / Type / Profile	Single Roll Price Per Roll
T-SR-TYCO-TE-608036-1 (ST1R236)	1 / 25.4	0.020 / 0.51	Red / II / Triangular	\$ 33.80
T-SR-TYCO-TE-608036-1B (ST1B236)	1 / 25.4	0.020 / 0.51	Black / II / Triangular	\$ 33.80
T-SR-TYCO-TE-608036-2 (ST1G236)	1 / 25.4	0.020 / 0.51	Gray / II / Triangular	\$ 33.80
T-SR-TYCO-TE-608036-4 (ST1G336)	1 / 25.4	0.030 / 0.76	Gray / II / Triangular	\$ 35.71
T-SR-TYCO-TE-608036-6 (ST14R436)	1.25 / 31.8	0.040 / 1.02	Red / II / Triangular	\$ 51.38
<b>Guideline Colour on Triangular Tapes Only:</b> .020" = blue / .030" = white / .040" = green				

- Standard roll length is 36 feet / 12 Yards / 10.9 Metres; other lengths available.



## FAA FAR 25.853 - Appendix F Horizontal and Vertical Burn Rate Limits Silicone Rubber Tape

500°F / 260°C: FlameShield™ Silicone Rubber Self Fusing Compression & Stretch  
Electrical Insulating Tape

*Self Binding Self-Fusing Tape - High Temperature, Heat & Flame Resistant*



- Self-bonds / self fuses / self amalgamating. No sticky residue or adhesive when removed. Starts fusing within minutes, fully bonded within hours. Excellent cold weather performance. Makes an excellent compression tape.
- Excellent for sealing ends of firesleeve: prevents sleeve from absorbing contamination and wicking liquids. Excellent for wrapping electrical & mechanical connections and splices. Makes clean and neat installations of cables, wires and hoses. Makes an instant separation bumper and provides vibration dampening.
- Meets Mil-I-46852 and AA59163 and other proprietary specifications.
- Meets FAR 25.853 Appendix F, section a, 1, iv – Horizontal burn rate.
- Meets FAR 25.853 Appendix F, section a, 1, ii – Vertical burn rate
- CofC available.

FlameShield™ FAA FAR 25.853 Tape High Temperature Silicone Rubber Self Fusing Compression/Stretch Tape			
Part Number	Tape Width Inches / mm	Tape Thickness Inches / mm	Price Per Roll
<b>FAA FAR 25.853 Type I Tape</b> (Other Widths / Thickness / Lengths Available)			
T-SR-FAR-1-08-20	1/2 / 13	0.020 / 0.51	\$ 37.96
T-SR-FAR-1-16-12	1 / 25	0.012 / 0.30	\$ 37.96
T-SR-FAR-1-16-20	1 / 25	0.020 / 0.51	\$ 43.96
<b>FAA FAR 25.853 Type II Tape</b> (Other Widths / Thickness / Lengths Available)			
T-SR-FAR-2-16-20	1 / 25	0.020 / 0.51	\$ 33.80
T-SR-FAR-2-16-30	1 / 25	0.030 / 0.76	\$ 42.88
T-SR-FAR-2-16-40	1 / 25	0.040 / 1.01	\$ 47.37

- Standard roll length is 36 feet / 12 Yards / 10.9 Metres; other lengths available.
- Color is brown only



**NSN & NATO Mil Spec Silicone Rubber Electrical Insulation Tapes**  
**500°F / 260°C: FlameShield™ MIL Spec Silicone Rubber Self Fusing Compression & Stretch Tape with National Stock Number (NSN & NATO)**  
**Meets MIL-I-46852 / A-A-59163 / MIL-I-22444 & Many Other Proprietary Specifications**  
**Self Binding Self-Fusing Tape - High Temperature, Heat & Flame Resistant**



- Self-bonds / self fuses / self amalgamating. No sticky residue or adhesive when removed. Starts fusing within minutes, fully bonded within hours. Excellent cold weather performance. Makes an excellent compression tape.
- Excellent for sealing ends of firesleeve: prevents sleeve from absorbing contamination and wicking liquids. Excellent for wrapping electrical & mechanical connections and splices. Makes clean and neat installations of cables, wires and hoses. Makes an instant separation bumper and provides vibration dampening. Secures insulation to hot air ducting.
- May meet MIL-I-46852, A-A-59163, MIL-I-22444 and many proprietary specifications. CofC available.

**Call for availability and pricing.**

**These tapes are not interchangeable. The NSN number specifies other parameters of the tape such as thickness, profile, width, reinforcement, rubber formulation, etc.**

**Some tapes are stock. Non stock items typically are 10 to 15 days to produce. Some may incur minimum order quantity (typically 18, 24, 30 or 36 rolls).**

**NSN / NATO National Stock Numbers**

5970-00-082-3226  
 5970-00-177-1627  
 5970-00-446-3928  
 5970-00-446-8928  
 5970-00-480-1329  
 5970-00-782-5056  
 5970-00-841-1172  
 5970-00-949-4846  
 5970-00-955-9976  
 5970-01-140-5672  
 5970-01-142-8454  
 5970-01-147-3595  
 5970-01-250-8756  
 5970-01-259-5830  
 5970-01-263-0373  
 5970-01-263-3931  
 5970-01-273-6030  
 5970-01-276-5277  
 5970-01-286-7456  
 5970-01-342-8289  
 5970-01-358-0397  
 5970-01-396-1601  
 5970-01-432-6018  
 5970-01-491-8992  
 5970-01-495-5211  
 5970-01-541-9092  
 9320-01-552-7024  
 5970-01-560-3208  
 5970-01-596-7929  
 8030-01-587-1885  
 5970-01-600-6091  
 5970-00-839-0824  
 5970-14-459-8605  
 5970-01-485-5980  
 5330-01-479-4233  
 5970-01-276-5277  
 5970-01-592-3238

**Color**

Black or Red  
 Black  
 Black  
 Red  
 Red  
 Red  
 Red  
 Red  
 Black  
 Red  
 Red  
 Red or Black  
 Red  
 Red or Black  
 Red  
 Black  
 Red or Black  
 Red or Black  
 Red  
 Black or Red  
 Red  
 Red  
 Black  
 Black  
 Red or Black  
 Red or Black  
 Red or Black  
 Red or Black  
 Red  
 Red  
 Red  
 Black  
 Red or Black  
 Black  
 Gray  
 Gray

**Our Part Number**

T-SR-NSN-00-082-3226  
 T-SR-NSN-00-177-1627  
 T-SR-NSN-00-446-3928  
 T-SR-NSN-00-446-8928  
 T-SR-NSN-00-480-1329  
 T-SR-NSN-00-782-5056  
 T-SR-NSN-00-841-1172  
 T-SR-NSN-00-949-4846  
 T-SR-NSN-00-955-9976  
 T-SR-NSN-01-140-5672  
 T-SR-NSN-01-142-8454  
 T-SR-NSN-01-147-3595  
 T-SR-NSN-01-250-8756  
 T-SR-NSN-01-259-5830  
 T-SR-NSN-01-263-0373  
 T-SR-NSN-01-263-3931  
 T-SR-NSN-01-273-6030  
 T-SR-NSN-01-276-5277  
 T-SR-NSN-01-286-7456  
 T-SR-NSN-01-342-8289  
 T-SR-NSN-01-358-0397  
 T-SR-NSN-01-396-1601  
 T-SR-NSN-01-432-6018  
 T-SR-NSN-01-491-8992  
 T-SR-NSN-01-495-5211  
 T-SR-NSN-01-541-9092  
 T-SR-NSN-01-552-7024  
 T-SR-NSN-01-560-3208  
 T-SR-NSN-01-560-3208  
 T-SR-NSN-01-596-7929  
 T-SR-NSN-01-587-1885  
 T-SR-NSN-01-600-6091  
 T-SR-NSN-00-839-0824  
 T-SR-NSN-14-459-8605  
 T-SR-NSN-01-485-5980  
 T-SR-NSN-01-479-4233  
 T-SR-NSN-01-276-5277  
 T-SR-NSN-01-592-3238

**TYT200-1 ColeFlex “No Heat” Equivalent Silicone Rubber Self Fusing Waterproof Insulating Tape**  
**500°F / 260°C: FlameShield™ - Meets MIL-I-46852 / A-A-59163 & Many Other Proprietary Specifications**  
**Self Binding Self-Fusing Tape - High Temperature, Heat & Flame Resistant**



- Self-bonds / self fuses / self amalgamating. No sticky residue or adhesive when removed. Starts fusing within minutes, fully bonded within hours. Excellent cold temperature performance. Makes an excellent compression tape.
- Excellent for sealing ends of firesleeve: prevents sleeve from absorbing contamination and wicking liquids. Excellent for wrapping electrical & mechanical connections and splices. Makes clean and neat installations of cables, wires and hoses. Makes an instant separation bumper and provides vibration dampening. Secures insulation to hot air ducting.
- Meets Mil-I-46852, AA59163 and many proprietary specifications.
- CofC available.

FlameShield™ TYT200-1 ColeFlex “No Heat” Equivalent Silicone Rubber Self Fusing Insulating Tape – Type I and Type II			
Part Number	Tape Width Inches / mm	Tape Thickness inches / mm	Price Per Roll Type I / Type II
<b>TYT200-1 Type I &amp; Type II</b>			
T-SR-TYT200-1-36-X-YY	1 / 25	0.020 / 0.51	\$ 34.71 / \$ 33.80
T-SR-TYT200-1-14-X-ZZ	1 / 25	0.020 / 0.51	\$ 23.87 / \$ 22.80

- For the X value (Type): I = Type I; II = Type II
- For the YY value (color code): OR = Oxide-Red, BK = Black
- For the ZZ value (color code): OR = Oxide-Red, BK = Black, WH = White, BU = Blue, GR = Green, YL = Yellow
- T-SR-TYT200-1-36 is a stock item; T-SR-TYT200-1-14 minimum order 36 rolls

## MOX 602 / MOX 603 / MOX 604 T Series MIL Spec Silicone Rubber Self Fusing Electrical Insulating Tape

500°F / 260°C: Meets MIL-I-46852 / A-A-59163 & Other Proprietary Specifications  
Self Binding Self-Fusing Tape - High Temperature, Heat & Flame Resistant

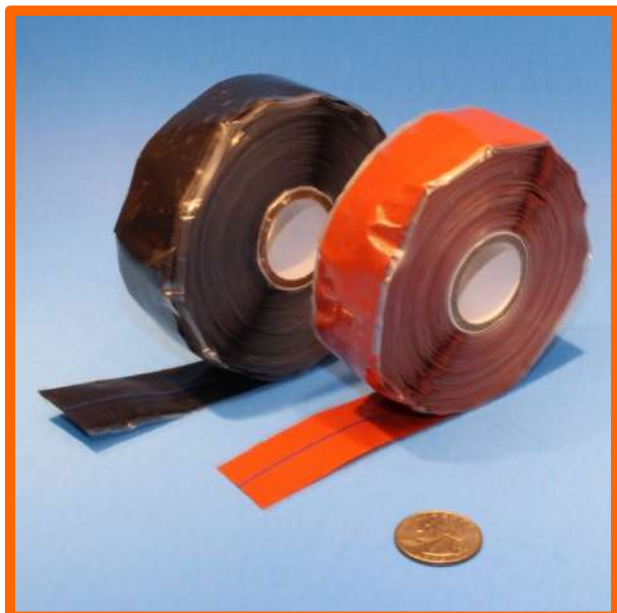

- Self-bonds / self fuses / self amalgamating. No sticky residue or adhesive when removed. Starts fusing within minutes, fully bonded within hours. Excellent cold weather performance. Makes an excellent compression tape.
- Excellent for sealing ends of firesleeve: prevents sleeve from absorbing contamination and wicking liquids. Excellent for wrapping electrical & mechanical connections and splices. Makes clean and neat installations of cables, wires and hoses. Makes an instant separation bumper and provides vibration dampening.
- Meets Mil-I-46852 and AA59163 specifications. Certification available.
- Standard roll length is 36 feet / 12 Yards / 10.9 Metres; other lengths available. For the XX value (color code): OR = Oxide-Red, BK = Black.
- CofC available.

MOX 602 / MOX 603 / MOX 604 T Series MIL Spec High Temperature Silicone Self Fusing Electrical Insulating Tape - Meets MIL-I-46852 and A-A-59163 Specifications				
Part Number	Tape Width Inches / mm	Thickness inches / mm	Type / Profile	Single Roll Price Per Roll
<b>602 / 603 / 604 Mil-I-46852 / AA59163 Tapes: Type II</b>				
T-SR-MOX-602-.75-TXX	3/4 / 19	0.020 / 0.50	II / Triangular	\$ 31.96
T-SR-MOX-602-1.0-TXX	1 / 25	0.020 / 0.50	II / Triangular	\$ 33.80
T-SR-MOX-602-1.5-TXX	1 1/2 / 38	0.020 / 0.50	II / Triangular	\$ 47.82
T-SR-MOX-603-.75-TXX	3/4 / 19	0.030 / 0.76	II / Triangular	\$ 35.16
T-SR-MOX-603-1.0-TXX	1 / 25	0.030 / 0.76	II / Triangular	\$ 37.18
T-SR-MOX-603-1.5-TXX	1 1/2 / 38	0.030 / 0.76	II / Triangular	\$ 52.60
T-SR-MOX-604-.75-TXX	3/4 / 19	0.040 / 1.0	II / Triangular	\$ 38.68
T-SR-MOX-604-1.0-TXX	1 / 25	0.040 / 1.0	II / Triangular	\$ 40.90
T-SR-MOX-604-1.5-TXX	1 1/2 / 38	0.040 / 1.0	II / Triangular	\$ 57.87

Please enquire for pricing on sizes other than those listed above.

This tape can be made in thicknesses from 0.010" to 0.080" and in various widths.

Amalgamating time: At 120°C; 120 minutes / at 150°C; 35 minutes / at 200°C; 20 minutes / at 250°C; 15 minutes

Tested for short duration fluid resistance: Jet Fuel (JP5), Hydraulic Fluid (Skydrol 500B4), Mineral Oil (NATO 0142), Synthetic Oil (NATO 0156), MIL-C-87836 & Foran 141B cleaning fluids, MIL-A-8243 cooling fluid.

Type II tapes have a center guideline stripe to assist in making 50% overwraps. The triangular profile version tape allows for minimal ridge lines, providing splices and joints with an almost totally smooth surface (prevents snagging when splice pulled through obstructions).

**MOX 615 / MOX 620 / MOX 630 / MOX 640 R Series MIL Spec Silicone Rubber Self Fusing Electrical Insulating Tape**  
**500°F / 260°C: Meets MIL-I-46852 / A-A-59163 & Other Proprietary Specifications**  
**Self Binding Self-Fusing Tape - High Temperature, Heat & Flame Resistant**



- Self-bonds / self fuses / self amalgamating. No sticky residue or adhesive when removed. Starts fusing within minutes, fully bonded within hours. Excellent cold weather performance. Makes an excellent compression tape.
- Excellent for sealing ends of firesleeve: prevents sleeve from absorbing contamination and wicking liquids. Excellent for wrapping electrical & mechanical connections and splices. Makes clean and neat installations of cables, wires and hoses. Makes an instant separation bumper and provides vibration dampening.
- Meets Mil-I-46852 and AA59163 specifications. Certification available.
- Standard roll length is 36 feet / 12 Yards / 10.9 Metres; other lengths available. For the XX value (color code): OR = Oxide-Red, BK = Black. CoC available.

<b>MOX 620 / MOX 630 / MOX 640 R Series MIL Spec High Temperature Silicone Self Fusing Electrical Insulating Tape. Meets MIL-I-46852 and A-A-59163 Specifications</b>				
<b>Part Number</b>	<b>Tape Width Inches / mm</b>	<b>Thickness inches / mm</b>	<b>Type / Profile</b>	<b>Single Roll Price Per Roll</b>
<b>MOX 615 / MOX 620 / MOX 630 / MOX 640 Mil-I-46852 / AA59163 Tapes: Type I</b>				
T-SR-MOX-615-1.0-RXX	1 / 25	0.015 / 0.38	I / Rectangular	\$ call
T-SR-MOX-620-.50-RXX	1/2 / 13	0.020 / 0.50	I / Rectangular	\$ 29.87
T-SR-MOX-620-.75-RXX	3/4 / 19	0.020 / 0.50	I / Rectangular	\$ 32.76
T-SR-MOX-620-1.0-RXX	1 / 25	0.020 / 0.50	I / Rectangular	\$ 34.71
T-SR-MOX-620-1.5-RXX	1 1/2 / 38	0.020 / 0.50	I / Rectangular	\$ 48.92
T-SR-MOX-630-.50-RXX	1/2 / 13	0.030 / 0.76	I / Rectangular	\$ 32.86
T-SR-MOX-630-.75-RXX	3/4 / 19	0.030 / 0.76	I / Rectangular	\$ 36.04
T-SR-MOX-630-1.0-RXX	1 / 25	0.030 / 0.76	I / Rectangular	\$ 38.18
T-SR-MOX-630-1.5-RXX	1 1/2 / 38	0.030 / 0.76	I / Rectangular	\$ 53.81
T-SR-MOX-640-.50-RXX	1/2 / 13	0.040 / 1.0	I / Rectangular	\$ 36.15
T-SR-MOX-640-.75-RXX	3/4 / 19	0.040 / 1.0	I / Rectangular	\$ 39.64
T-SR-MOX-640-1.0-RXX	1 / 25	0.040 / 1.0	I / Rectangular	\$ 41.99
T-SR-MOX-640-1.5-RXX	1 1/2 / 38	0.040 / 1.0	I / Rectangular	\$ 59.19

**Please enquire for pricing on sizes other than those listed above.**

**This tape can be made in thicknesses from 0.010" to 0.080" and in various widths.**

Amalgamating time: At 120°C; 120 minutes / at 150°C; 35 minutes / at 200°C; 20 minutes / at 250°C; 15 minutes

Tested for short duration fluid resistance: Jet Fuel (JP5), Hydraulic Fluid (Skydrol 500B4), Mineral Oil (NATO 0142), Synthetic Oil (NATO 0156), MIL-C-87836 & Foran 141B cleaning fluids, MIL-A-8243 cooling fluid.



## MOX 15% & 25% Reinforced / Supported Silicone Rubber Self Fusing Electrical Insulating Tape

500°F / 260°C: Meets MIL-I-24222 & Other Proprietary Specifications

Self Binding Self-Fusing Tape - High Temperature, Heat & Flame Resistant



- Self-bonds / self fuses / self amalgamating. No sticky residue or adhesive when removed. Starts fusing within minutes, fully bonded within hours. Excellent cold weather performance. Makes an excellent compression tape.
- Excellent for sealing ends of firesleeve: prevents sleeve from absorbing contamination and wicking liquids. Excellent for wrapping electrical & mechanical connections and splices. Makes clean and neat installations of cables, wires and hoses. Makes an instant separation bumper and provides vibration dampening.
- Meets Mil-I-22444 specifications. Certification available.
- Standard roll length is 36 feet / 12 Yards / 10.9 Metres; other lengths available. For the XX value (color code): OR = Oxide-Red, BK = Black.
- CofC available.

MOX 25% Series MIL Spec High Temperature Silicone Self Fusing Electrical Insulating Tape. Meets MIL-I-22444 Specifications				
Part Number	Tape Width Inches / mm	Thickness inches / mm	Type / Profile	Single Roll Price Per Roll
T-MOX-SA00520-RXX	1/2 / 13	0.020 / 0.50	I / Rectangular	\$
T-MOX-SA00720-RXX	3/4 / 19	0.020 / 0.50	I / Rectangular	\$
T-MOX-SA01020-RXX	1 / 25	0.020 / 0.50	I / Rectangular	\$
T-MOX-SA01520-RXX	1 1/2 / 38	0.020 / 0.50	I / Rectangular	\$
T-MOX-SA00530-RXX	1/2 / 13	0.030 / 0.76	I / Rectangular	\$
T-MOX-SA00730-RXX	3/4 / 19	0.030 / 0.76	I / Rectangular	\$
T-MOX-SA01030-RXX	1 / 25	0.030 / 0.76	I / Rectangular	\$
T-MOX-SA01530-RXX	1 1/2 / 38	0.030 / 0.76	I / Rectangular	\$
T-MOX-SA00540-RXX	1/2 / 13	0.040 / 1.0	I / Rectangular	\$
T-MOX-SA00740-RXX	3/4 / 19	0.040 / 1.0	I / Rectangular	\$
T-MOX-SA01040-RXX	1 / 25	0.040 / 1.0	I / Rectangular	\$
T-MOX-SA01540-RXX	1 1/2 / 38	0.040 / 1.0	I / Rectangular	\$



## MOX 15% Reinforced / Supported Silicone Rubber Self Fusing Electrical Insulating Tape

500°F / 260°C: Meets MIL-I-24222 & Other Proprietary Specifications

Self Binding Self-Fusing Tape - High Temperature, Heat & Flame Resistant



MOX 15% Series MIL Spec High Temperature Silicone Self Fusing Electrical Insulating Tape. Meets MIL-I-22444 Specifications				
Part Number	Tape Width Inches / mm	Thickness inches / mm	Type / Profile	Single Roll Price Per Roll
T-MOX-SB00520-RXX	1/2 / 13	0.020 / 0.50	I / Rectangular	\$
T-MOX-SB00720-RXX	3/4 / 19	0.020 / 0.50	I / Rectangular	\$
T-MOX-SB01020-RXX	1 / 25	0.020 / 0.50	I / Rectangular	\$
T-MOX-SB01520-RXX	1 1/2 / 38	0.020 / 0.50	I / Rectangular	\$
T-MOX-SB00530-RXX	1/2 / 13	0.030 / 0.76	I / Rectangular	\$
T-MOX-SB00730-RXX	3/4 / 19	0.030 / 0.76	I / Rectangular	\$
T-MOX-SB01030-RXX	1 / 25	0.030 / 0.76	I / Rectangular	\$
T-MOX-SB01530-RXX	1 1/2 / 38	0.030 / 0.76	I / Rectangular	\$
T-MOX-SB00540-RXX	1/2 / 13	0.040 / 1.0	I / Rectangular	\$
T-MOX-SB00740-RXX	3/4 / 19	0.040 / 1.0	I / Rectangular	\$
T-MOX-SB01040-RXX	1 / 25	0.040 / 1.0	I / Rectangular	\$
T-MOX-SB01540-RXX	1 1/2 / 38	0.040 / 1.0	I / Rectangular	\$

Please enquire for pricing on sizes other than those listed above.

This tape can be made in thicknesses from 0.010" to 0.080" and in various widths.

Amalgamating time: At 120°C; 120 minutes / at 150°C; 35 minutes / at 200°C; 20 minutes / at 250°C; 15 minutes

Tested for short duration fluid resistance: Jet Fuel (JP5), Hydraulic Fluid (Skydrol 500B4), Mineral Oil (NATO 0142), Synthetic Oil (NATO 0156), MIL-C-87836 & Foran 141B cleaning fluids, MIL-A-8243 cooling fluid.

**Nimikkeistokeskus NCB Finland 10134254 Series MIL Spec Silicone Rubber Self Fusing Electrical Insulating Tape**  
**500°F / 260°C: Meets MIL-I-46852 / A-A-59163 & Other Proprietary Specifications**  
**Self Binding Self-Fusing Tape - High Temperature, Heat & Flame Resistant**

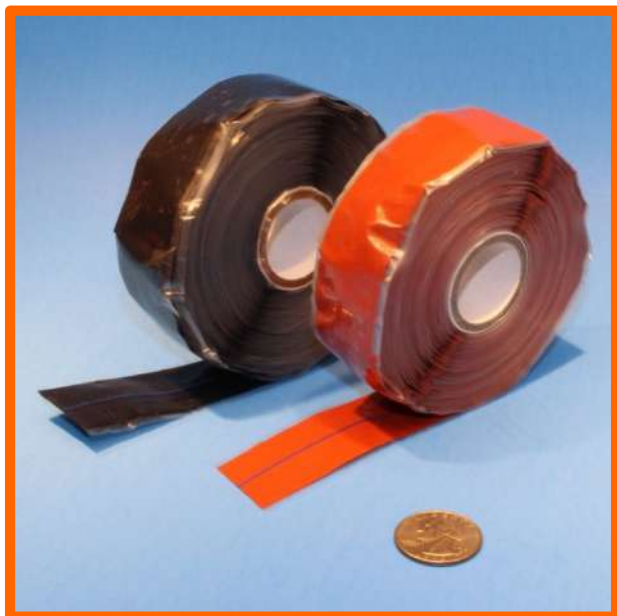

- Self-bonds / self fuses / self amalgamating. No sticky residue or adhesive when removed. Starts fusing within minutes, fully bonded within hours. Excellent cold weather performance. Makes an excellent compression tape.
- Excellent for sealing ends of firesleeve: prevents sleeve from absorbing contamination and wicking liquids. Excellent for wrapping electrical & mechanical connections and splices. Makes clean and neat installations of cables, wires and hoses. Makes an instant separation bumper and provides vibration dampening.
- Meets Mil-I-46852 and AA59163 specifications. Certification available.
- Standard roll length is 36 feet / 12 Yards / 10.9 Metres; other lengths available. For the XX value (color code): OR = Oxide-Red, BK = Black.
- CofC available.

Nimikkeistokeskus NCB Finland 10134254 Equivalent Series MIL Spec High Temperature Silicone Self Fusing Electrical Insulating Tape - Meets MIL-I-46852 and A-A-59163 Specifications				
Part Number	Tape Width Inches / mm	Thickness inches / mm	Type / Profile	Single Roll Price Per Roll
<b>10134254 Mil-I-46852 / AA59163 Tape: Type II</b>				
T-SR-NCBFIN-10134254-XX	1 / 25	0.040 / 1.0	II / Triangular	\$ 40.90

**Please enquire for pricing on sizes other than those listed above.**  
**This tape can be made in thicknesses from 0.010" to 0.080" and in various widths.**

Amalgamating time: At 120°C; 120 minutes / at 150°C; 35 minutes / at 200°C; 20 minutes / at 250°C; 15 minutes

Tested for short duration fluid resistance: Jet Fuel (JP5), Hydraulic Fluid (Skydrol 500B4), Mineral Oil (NATO 0142), Synthetic Oil (NATO 0156), MIL-C-87836 & Foran 141B cleaning fluids, MIL-A-8243 cooling fluid.

Type II tapes have a center guideline stripe to assist in making 50% overwraps. The triangular profile version tape allows for minimal ridge lines, providing splices and joints with an almost totally smooth surface (prevents snagging when splice pulled through obstructions).

**Markel 4529670544 NSN 5970-00-955-9976 Equivalent MIL Spec Silicone Rubber Self Fusing Electrical Insulating Tape**  
**500°F / 260°C: Meets MIL-I-46852 / A-A-59163 & Other Proprietary Specifications**  
**Self Binding Self-Fusing Tape - High Temperature, Heat & Flame Resistant**



- Self-bonds / self fuses / self amalgamating. No sticky residue or adhesive when removed. Starts fusing within minutes, fully bonded within hours. Excellent cold weather performance. Makes an excellent compression tape.
- Excellent for sealing ends of firesleeve: prevents sleeve from absorbing contamination and wicking liquids. Excellent for wrapping electrical & mechanical connections and splices. Makes clean and neat installations of cables, wires and hoses. Makes an instant separation bumper and provides vibration dampening.
- Meets Mil-I-46852 and AA59163 specifications. Certification available.
- Standard roll length is 36 feet / 12 Yards / 10.9 Metres; other lengths available. For the XX value (color code): OR = Oxide-Red, BK = Black. CofC available.

Markel 4529670544 NSN 5970-00-955-9976 Equivalent Series MIL Spec High Temperature Silicone Self Fusing Electrical Insulating Tape - Meets MIL-I-46852 and A-A-59163 Specifications				
Part Number	Tape Width Inches / mm	Thickness inches / mm	Type / Profile	Single Roll Price Per Roll
<b>Markel 4529670544 Equivalent Mil-I-46852 / AA59163 Tape: Type II</b>				
T-SR-Markel-4529670544-XX	1 / 25	0.040 / 1.0	II / Triangular	\$ 40.90

**Please enquire for pricing on sizes other than those listed above.**  
**This tape can be made in thicknesses from 0.010" to 0.080" and in various widths.**

Amalgamating time: At 120°C; 120 minutes / at 150°C; 35 minutes / at 200°C; 20 minutes / at 250°C; 15 minutes

Tested for short duration fluid resistance: Jet Fuel (JP5), Hydraulic Fluid (Skydrol 500B4), Mineral Oil (NATO 0142), Synthetic Oil (NATO 0156), MIL-C-87836 & Foran 141B cleaning fluids, MIL-A-8243 cooling fluid.

Type II tapes have a center guideline stripe to assist in making 50% overwraps. The triangular profile version tape allows for minimal ridge lines, providing splices and joints with an almost totally smooth surface (prevents snagging when splice pulled through obstructions).

**66N / 67N / 69N / 78N / 79N Equivalent Silicone Rubber Self Fusing Electrical Insulating Tape**  
**500°F / 260°C: FlameShield™ Meets MIL-I-46852 / A-A-59163 / MIL-I-22444 & Many Other OEM Specifications**  
**Self Binding Self-Fusing Tape - High Temperature, Heat & Flame Resistant**



- Self-bonds / self fuses / self amalgamating. No sticky residue or adhesive when removed. Starts fusing within minutes, fully bonded within hours. Excellent cold temperature performance. Makes an excellent compression tape.
- Excellent for sealing ends of firesleeve: prevents sleeve from absorbing contamination and wicking liquids. Excellent for wrapping electrical & mechanical connections and splices. Makes clean and neat installations of cables, wires and hoses. Makes an instant separation bumper and provides vibration dampening. Secures insulation to hot air ducting.
- Unsupported tape meets Mil-I-46852, AA59163 and many other specifications. Supported tape meets MIL-I-22444 and many other specifications.
- CofC available.

- T-SR-66N-5970-14-467-8824 meets NATO/NSN 5970-14-467-8824 and ABS 5334 specification. Oxide-Red / Red-Brown Color. T-SR-67N-5970-14-474-7041 meets NATO/NSN 5970-14-474-7041 and ABS 5334 specification. Black Color. T-SR-SB15-68N-5970-14-464-7312 meets NATO/NSN 5970-14-464-7312 and ASNA 5107 specification. Oxide-Red / Red-Brown Color.

<b>FlameShield™ 66N / 67N / 68N / 69N / 78N / 79N Silicone Rubber Self Fusing Electrical Insulation Tape</b>			
<b>Part Number</b>	<b>Tape Width Inches / mm</b>	<b>Tape Thickness inches / mm</b>	<b>Price Per Roll</b>
<b>Unsupported Tape – No Fiberglass Substrate – 300% to 500% Elongation</b>			
T-SR-66N-5970-14-467-8824-OR	0.75 / 19	0.012 / 0.30	\$ 24.64
T-SR-67N-5970-14-474-7041-BK	0.75 / 19	0.020 / 0.51	\$ 26.80
<b>Supported Tape – With Fiberglass Substrate – 15% Maximum Elongation</b>			
T-SR-SB15-69N-BK	0.75 / 19	0.020 / 0.51	\$ 64.82
T-SR-SB15-78N-OR	1.00 / 25	0.020 / 0.51	\$ 67.29
T-SR-SB15-79N-BK	1.00 / 25	0.020 / 0.51	\$ 67.29

Amalgamating time: At 120°C; 120 minutes / at 150°C; 35 minutes / at 200°C; 20 minutes / at 250°C; 15 minutes

Tested for short duration fluid resistance: Jet Fuel (JP5), Hydraulic Fluid (Skydrol 500B4), Mineral Oil (NATO 0142), Synthetic Oil (NATO 0156), MIL-C-87836 & Foran 141B cleaning fluids, MIL-A-8243 cooling fluid.

**RL6000SA / RL6000SB Stretchtape™ Equivalent**  
**Silicone Rubber Self Fusing Electrical Insulating Tape**  
**500°F / 260°C: Meets MIL-I-22444 & Many OEM Specifications**  
**Self Binding Self-Fusing Tape - High Temperature, Heat & Flame Resistant**



- Self-bonds / self fuses / self amalgamating. No sticky residue or adhesive when removed. Starts fusing within minutes, fully bonded within hours. Excellent cold temperature performance. Makes an excellent compression tape.
- Excellent for sealing ends of firesleeve: prevents sleeve from absorbing contamination and wicking liquids. Excellent for wrapping electrical & mechanical connections and splices. Makes clean and neat installations of cables, wires and hoses. Makes an instant separation bumper and provides vibration dampening. Secures insulation to hot air ducting.
- CofC available.
- Rolls are 12 or 20 yards long.
- This tape meets the following specifications:  
 DMS 2186, Type 1 / RMS 315, Type 1  
 IBM PN 6084744 / MIL – 1-22444  
 GE A50493 / AE 26495-001  
 GE A50E112 (SB only) / ASNA 5107

<b>RL6000SA / RL6000SB Stretchtape™ Equivalent</b>			
<b>Silicone Rubber Self Fusing Electrical Insulating Tape</b>			
<b>Part Number</b>	<b>Tape Width Inches / mm</b>	<b>Tape Thickness inches / mm</b>	<b>Price Per Roll</b>
<b>Supported Tape – With Fiberglass Substrate – 15% (SB) or 25% (SA) Maximum Elongation</b>			
T-SR-RL6000SA-12Y-08-XX (12 yard roll)	0.50 / 13	0.020 / 0.51	\$ 56.33
T-SR-RL6000SB-12Y-08-XX (12 yard roll)	0.50 / 13	0.020 / 0.51	\$ 56.33
T-SR-RL6000SA-12Y-12-XX (12 yard roll)	0.75 / 19	0.020 / 0.51	\$ 64.82
T-SR-RL6000SB-12Y-12-XX (12 yard roll)	0.75 / 19	0.020 / 0.51	\$ 64.82
T-SR-RL6000SA-12Y-16-XX (12 yard roll)	1.00 / 25	0.020 / 0.51	\$ 67.29
T-SR-RL6000SB-12Y-16-XX (12 yard roll)	1.00 / 25	0.020 / 0.51	\$ 67.29
T-SR-RL6000SA-20Y-16-XX (20 yard roll)	1.00 / 25	0.020 / 0.51	\$ 127.97
T-SR-RL6000SB-20Y-16-XX (20 yard roll)	1.00 / 25	0.020 / 0.51	\$ 127.97

- For the XX value (color code): OR = Oxide-Red, BK = Black
- 12Y/20Y in part number: 12Y = 12 yard roll length. 20Y = 20 yard roll length

T-SR-RL6000SA-XX equivalent to NSN 5970-01-325-8971. T-SR-RL6000SB-XX equivalent to NSN 5970-00-841-1172

Amalgamating time: At 120°C; 120 minutes / at 150°C; 35 minutes / at 200°C; 20 minutes / at 250°C; 15 minutes

Stretchtape™ is a trademark of Kirkhill-TA / Esterline





## ASNA 5107 Airbus Standard Silicone Rubber Self Fusing Electrical Insulating Tape

500°F / 260°C: Meets MIL-I-22444 & Many Other OEM Specifications

Self Binding Self-Fusing Tape - High Temperature, Heat & Flame Resistant



- Self-bonds / self fuses / self amalgamating. No sticky residue or adhesive when removed. Starts fusing within minutes, fully bonded within hours. Excellent cold temperature performance. Makes an excellent compression tape.
- Excellent for sealing ends of firesleeve: prevents sleeve from absorbing contamination and wicking liquids. Excellent for wrapping electrical & mechanical connections and splices. Makes clean and neat installations of cables, wires and hoses. Makes an instant separation bumper and provides vibration dampening. Secures insulation to hot air ducting.
- CofC available.
- Rolls are 12 or 20 yards long.

### ASNA 5107 Airbus Standard Equivalent Silicone Rubber Self Fusing Electrical Insulating Tape

Part Number	Tape Width Inches / mm	Tape Thickness inches / mm	Price Per Roll
<b>Supported Tape – With Fiberglass Substrate – 25% Maximum Elongation</b>			
T-SR- ASNA5107-2503-12Y-16-XX (12 yard roll)	1.00 / 25	0.020 / 0.51	\$ 67.29
T-SR- ASNA5107-2503-20Y-16-XX (20 yard roll)	1.00 / 25	0.020 / 0.51	\$ 127.97

- For the XX value (color code): OR = Oxide-Red, BK = Black
- 12Y/20Y in part number: 12Y = 12 yard roll length. 20Y = 20 yard roll length

Amalgamating time: At 120°C; 120 minutes / at 150°C; 35 minutes / at 200°C; 20 minutes / at 250°C; 15 minutes

## ABS 5334A01B & ABS 5334A02R Airbus Standard Silicone Rubber Self Fusing / Self Amalgamating Electrical Insulating Tape

500°F / 260°C

*Self Binding Self-Fusing Tape - High Temperature, Heat & Flame Resistant*



- Self-bonds / self fuses / self amalgamating. No sticky residue or adhesive when removed. Starts fusing within minutes, fully bonded within hours. Excellent cold temperature performance. Makes an excellent compression tape.
- Excellent for sealing ends of firesleeve: prevents sleeve from absorbing contamination and wicking liquids. Excellent for wrapping electrical & mechanical connections and splices. Makes clean and neat installations of cables, wires and hoses. Makes an instant separation bumper and provides vibration dampening. Secures insulation to hot air ducting.
- Unsupported tape meets Mil-I-46852, AA59163 and many other specifications.
- CofC available.

### FlameShield™ ABS 5334A01B & ABS 5334A02R Airbus Standard Silicone Rubber Self Fusing Electrical Insulation Tape

Part Number	Tape Width Inches / mm	Tape Thickness inches / mm	Price Per Roll
T-SR-ABS5334A02R-66N-ROR	0.75 / 19	0.012 / 0.30	\$ 24.64
T-SR-ABS5334A01B-67N-RBK	0.75 / 19	0.020 / 0.51	\$ 26.80

Amalgamating time: At 120°C; 120 minutes / at 150°C; 35 minutes / at 200°C; 20 minutes / at 250°C; 15 minutes

Tested for short duration fluid resistance: Jet Fuel (JP5), Hydraulic Fluid (Skydrol 500B4), Mineral Oil (NATO 0142), Synthetic Oil (NATO 0156), MIL-C-87836 & Foran 141B cleaning fluids, MIL-A-8243 cooling fluid.

**Eaton Weatherhead® A6900W equivalent Silicone Elastomer Tape**  
**Meets MIL-I-46852 / A-A-59163 & Many Other Proprietary Specifications**  
**Self Binding Self-Fusing Tape - High Temperature, Heat & Flame Resistant**



- Self-bonds / self fuses / self amalgamating. No sticky residue or adhesive when removed. Starts fusing within minutes, fully bonded within hours. Excellent cold temperature performance. Makes an excellent compression tape.
- Excellent for sealing ends of firesleeve: prevents sleeve from absorbing contamination and wicking liquids. Excellent for wrapping electrical & mechanical connections and splices. Makes clean and neat installations of cables, wires and hoses. Makes an instant separation bumper and provides vibration dampening. Secures insulation to hot air ducting.
- Meets Mil-I-46852 and AA59163 specifications.
- CofA Available.

Eaton Weatherhead® A6900W Equivalent Silicone Rubber Self Fusing Insulating Tape			
Part Number	Tape Width Inches / mm	Tape Length, inches / yards	Price Per Roll
T-SR-A6900W-OR	1 / 25	432 / 12	\$ 33.80
T-SR-A6900W-BK	1 / 25	432 / 12	\$ 33.80

- OR = Oxide-Red, BK = Black

Weatherhead® is a registered trademark of Eaton Hydraulics

**Seal-Tite™ P29950 / P28566 / P40630 / P36728 Fusion Wrap**  
**equivalent Silicone Elastomer Tape**  
**Meets MIL-I-46852 / A-A-59163 & Many Other Proprietary Specifications**  
**Self Binding Self-Fusing Tape - High Temperature, Heat & Flame Resistant**



- Self-bonds / self fuses / self amalgamating. No sticky residue or adhesive when removed. Starts fusing within minutes, fully bonded within hours. Excellent cold temperature performance. Makes an excellent compression tape.
- Excellent for sealing ends of firesleeve: prevents sleeve from absorbing contamination and wicking liquids. Excellent for wrapping electrical & mechanical connections and splices. Makes clean and neat installations of cables, wires and hoses. Makes an instant separation bumper and provides vibration dampening. Secures insulation to hot air ducting.
- Meets Mil-I-46852 and AA59163 specifications. CofC Available.
- Standard length is 36 feet. Longer roll lengths available. Tapes are .020" thick

<b>Seal-Tite™ P29950 / P28566 / P40630 / P36728 Fusion Wrap</b> <b>Equivalent Silicone Rubber Self Fusing Electrical Insulating Tape</b>			
<b>Part Number</b>	<b>Tape Width Inches / mm</b>	<b>Tape Length, inches / yards</b>	<b>Price Per Roll</b>
T-SR-P29950-FL-GY	1 / 25	648 / 18	\$ 44.94
T-SR-P28566-FL-BK	1 / 25	648 / 18	\$ 44.94
T-SR-P40630-FL-CL	1 / 25	648 / 18	\$ 44.94
T-SR-P36728-FL-OR	1 / 25	648 / 18	\$ 44.94
T-SR-P29950-SL-GY	1 / 25	432 / 12	\$ 33.80
T-SR-P28566-SL-BK	1 / 25	432 / 12	\$ 33.80
T-SR-P40630-SL-CL	1 / 25	432 / 12	\$ 33.80
T-SR-P36728-SL-OR	1 / 25	432 / 12	\$ 33.80

- GY = Gray, OR = Oxide-Red, BK = Black, CL = Clear

Seal-Tite™ is a trademark of LAWSON Products



## ARMET® GUIDELINE® Simrit® – Freudenberg-NOK Equivalent Silicone Tape – Type I & Type II

500°F / 260°C: MIL Spec Silicone Rubber Self Fusing Electrical Insulating Tape

Meets MIL-I-46852 / A-A-59163 & Many Other Proprietary Specifications

Self Binding Self-Fusing Tape - High Temperature, Heat & Flame Resistant



- Self-bonds / self fuses / self amalgamating. No sticky residue or adhesive when removed. Starts fusing within minutes, fully bonded within hours. Excellent cold weather performance. Makes an excellent compression tape.
- Excellent for sealing ends of firesleeve: prevents sleeve from absorbing contamination and wicking liquids. Excellent for wrapping electrical & mechanical connections and splices. Makes clean and neat installations of cables, wires and hoses. Makes an instant separation bumper and provides vibration dampening.
- Meets Mil-I-46852 and AA59163 specifications. CofC available.
- Standard roll length is 36 feet / 12 Yards / 10.9 Metres; other lengths available. For the XX value (color code): OR = Oxide-Red, BK = Black. For the "Z" Value: Substitute "CT" for Certified Tape or "NC" for Not Certified. Add \$6.00 for individual roll CofC. Lot/Batch CofC \$10.00 per order line item.

### ARMET® GUIDELINE® Simrit® Equivalent Silicone Tapes Meets MIL-I-46852 / A-A-59163 Specifications Type I & Type II

Part Number	Tape Width Inches / mm	Thickness inches / mm	Type / Profile	Single Roll Price Per Roll
<b>Mil-I-46852 / AA59163 Tapes: Type I</b>				
T-SR-ARMET-SIMRIT-56756-RXX	1 / 25	0.012 / 0.30	I / Rectangular	\$ Call
T-SR-ARMET-SIMRIT-57063-RXX	3/4 / 19	0.015 / 0.38	I / Rectangular	\$ Call
T-SR-ARMET-SIMRIT-57090-RXX	1 / 25	0.015 / 0.38	I / Rectangular	\$ Call
T-SR-ARMET-SIMRIT-50005-RXX	1 ½ / 38	0.020 / 0.51	I / Rectangular	\$ 48.77
T-SR-ARMET-SIMRIT-50006-RXX	2 / 51	0.020 / 0.51	I / Rectangular	\$ 57.13
T-SR-ARMET-SIMRIT-57161-RXX	1 / 25	0.020 / 0.51	I / Rectangular	\$ 34.71
T-SR-ARMET-SIMRIT-50022-RXX	1 1/4 / 32	0.020 / 0.51	I / Rectangular	\$ Call
T-SR-ARMET-SIMRIT-50039-RXX	1/2 / 13	0.030 / 0.76	I / Rectangular	\$ Call
T-SR-ARMET-SIMRIT-57806-RXX	1 / 25	0.030 / 0.76	I / Rectangular	\$ Call
<b>Mil-I-46852 / AA59163 Tapes: Type II</b>				
T-SR-ARMET-SIMRIT-50014-TXX	1 / 25	0.020 / 0.51	II / Triangular	\$ 33.80
T-SR-ARMET-SIMRIT-50215-TXX	1 / 25	0.030 / 0.76	II / Triangular	\$ Call
T-SR-ARMET-SIMRIT-50361-TXX	1 / 25	0.040 / 1.01	II / Triangular	\$ 37.91
T-SR-ARMET-SIMRIT-53304-TXX	1 1/4 / 32	0.040 / 1.01	II / Triangular	\$ Call
T-SR-ARMET-SIMRIT-50573-TXX	1 1/4 / 32	0.050 / 1.27	II / Triangular	\$ Call
T-SR-ARMET-SIMRIT-56517-TXX	1 ½ / 38	0.050 / 1.27	II / Triangular	\$ Call
T-SR-ARMET-SIMRIT-56265-TXX	1 ½ / 38	0.060 / 1.52	II / Triangular	\$ Call

Amalgamating time: At 120°C; 120 minutes / at 150°C; 35 minutes / at 200°C; 20 minutes / at 250°C; 15 minutes

Simrit® is a registered trademark of Freudenberg NOK



## Simrit® – Freudenberg-NOK Equivalent Silicone Rubber Tape – Reinforced & Controlled Elongation

500°F / 260°C: MIL Spec Silicone Rubber Self Fusing Electrical Insulating Tape Meets MIL-I-22444, MIL-I-46852 / A-A-59163 & Many Other OEM Specifications  
*Self Binding Self-Fusing Tape - High Temperature, Heat & Flame Resistant*



- Self-bonds / self fuses / self amalgamating. No sticky residue or adhesive when removed. Starts fusing within minutes, fully bonded within hours. Excellent cold weather performance. Makes an excellent compression tape.
- Excellent for sealing ends of firesleeve: prevents sleeve from absorbing contamination and wicking liquids. Excellent for wrapping electrical & mechanical connections and splices. Makes clean and neat installations of cables, wires and hoses. Makes an instant separation bumper and provides vibration dampening.
- Meets Mil-I-46852 and AA59163 specifications. CofC available.
- Standard roll length is 36 feet / 12 Yards / 10.9 Metres; other lengths available. For the XX value (color code): OR = Oxide-Red, BK = Black. For the "Z" Value: Substitute "CT" for Certified Tape or "NC" for Not Certified. Add \$6.00 for individual roll CofC. Lot/Batch CofC \$10.00 per order line item.

Simrit® Equivalent Silicone Tapes – Reinforced Controlled Elongation Tape Meets MIL-I-22444, MIL-I-46852 / A-A-59163 Specifications: Type I Supported				
Part Number	Tape Width Inches / mm	Thickness inches / mm	Type / Profile	Single Roll Price Per Roll
<b>Mil-I-22444 Reinforced Controlled Elongation Tape</b>				
T-SR-SIMRIT-22444-58609-RXX	1 / 25	0.015 / 0.38	I / Rectangular	\$ Call
T-SR-SIMRIT-22444-58607-RXX	1 / 25	0.015 / 0.38	I / Rectangular	\$ Call
T-SR-SIMRIT-22444-58613-RXX	1/2 / 13	0.020 / 0.51	I / Rectangular	\$ Call
T-SR-SIMRIT-22444-58611-RXX	1/2 / 13	0.020 / 0.51	I / Rectangular	\$ Call
T-SR-SIMRIT-22444-58615-RXX	1 / 25	0.020 / 0.51	I / Rectangular	\$ Call
T-SR-SIMRIT-22444-58617-RXX	1 / 25	0.020 / 0.51	I / Rectangular	\$ Call
T-SR-SIMRIT-22444-58621-RXX	1 / 25	0.050 / 1.27	I / Rectangular	\$ Call
T-SR-SIMRIT-22444-58619-RXX	1 / 25	0.050 / 1.27	I / Rectangular	\$ Call

Amalgamating time: At 120°C; 120 minutes / at 150°C; 35 minutes / at 200°C; 20 minutes / at 250°C; 15 minutes

Simrit® is a registered trademark of Freudenberg NOK



**FNOK 52152 Ace 90052152 NSN 5970-01-450-4130 Silicone Rubber Tape**  
**500°F / 260°C: FlameShield™ Silicone Rubber Self Fusing Compression & Stretch**  
**Electrical Insulating Tape**  
*Self Binding Self-Fusing Tape - High Temperature, Heat & Flame Resistant*

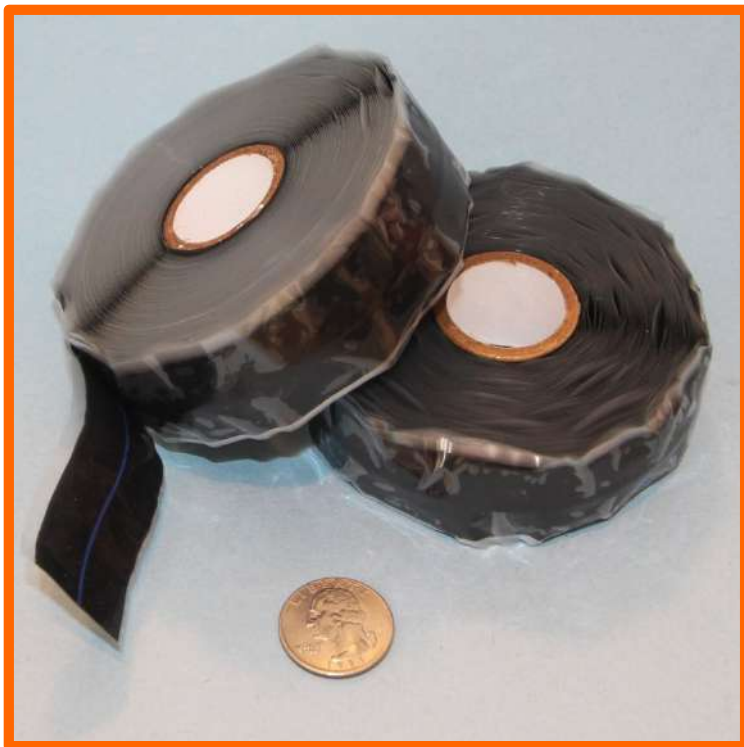

- Self-bonds / self fuses / self amalgamating. No sticky residue or adhesive when removed. Starts fusing upon contact, fully bonded within hours. Excellent cold weather performance. Makes an excellent compression tape.
- Excellent for sealing ends of firesleeve: prevents sleeve from absorbing contamination and wicking liquids. Excellent for wrapping electrical & mechanical connections and splices. Makes clean and neat installations of cables, wires and hoses. Makes an instant separation bumper and provides vibration dampening.
- Meets Mil-I-22444 and other proprietary specifications.
- CofC available.
- Mfg Cage code L8347

FlameShield™ High Temperature Silicone Rubber Self Fusing Compression/Stretch Electrical Insulating Tape Meets FNOK 52152 / Ace 90052152 Specifications			
Part Number	Tape Width	Tape Thickness inches / mm	Price Per Roll
<b>Specification NSN 5970-01-450-4130</b>			
90052152	3/4"	.050"	\$ call

- Standard roll length is 36 feet / 12 Yards / 10.9 Metres; other lengths available.

These tapes are guaranteed to meet specification for 1 year from date of manufacture providing tapes are stored dry at 21°C +/- 3°C or 70°F +/- 5°F. Standard tapes have an interleaved liner of polyethylene. Polyester liner available.

**L-3 Communications Tape, Electrical,  
Silicone Self-Fusing, Non-Reinforced**  
500°F / 260°C: Meeting A-A-59163 Class 1, Type I Specifications  
Also meets MIL-I-46852 & Many Other OEM Specifications  
*Self Binding Self-Fusing Tape - High Temperature, Heat & Flame Resistant*



- Self-bonds / self fuses / self amalgamating. No sticky residue or adhesive when removed. Starts fusing within minutes, fully bonded within hours. Excellent cold weather performance. Makes an excellent compression tape.
- Excellent for sealing ends of firesleeve: prevents sleeve from absorbing contamination and wicking liquids. Excellent for wrapping electrical & mechanical connections and splices. Makes clean and neat installations of cables, wires and hoses. Makes an instant separation bumper and provides vibration dampening.
- Meets A-A-59163 and MIL-I-46852 specifications.
- Standard roll length is 36 feet / 12 Yards / 10.9 Metres; other lengths available. Color is Black.
- CofC available.
- Cage Code L8347.

<b>L-3 Communications Tape, Electrical, Silicone Self-Fusing, Non-Reinforced</b>				
<b>Meets A-A-59163 Specifications: Class 1, Type I</b>				
<b>Part Number</b>	<b>Tape Width Inches / mm</b>	<b>Thickness inches / mm</b>	<b>Type / Profile</b>	<b>Single Roll Price Per Roll</b>
T-SR-40014362-000	1/2 / 13	0.020 / 0.5	I / Rectangular	\$ 29.37
T-SR-40014362-001	3/4 / 19	0.020 / 0.5	I / Rectangular	\$ 31.96
T-SR-40014362-002	1 / 25	0.020 / 0.5	I / Rectangular	\$ 34.71
T-SR-40014362-003	1.25 / 32	0.020 / 0.5	I / Rectangular	\$ 41.77

**MS70T09-S - NSN 5970-00-955-9976 Silicone Rubber Tape**  
**500°F / 260°C: FlameShield™ Silicone Rubber Self Fusing Compression & Stretch**  
**Electrical Insulating Tape**  
*Self Binding Self-Fusing Tape - High Temperature, Heat & Flame Resistant*



- Meets MS70T09-S specifications.
- Self-bonds / self fuses / self amalgamating. No sticky residue or adhesive when removed. Starts fusing upon contact, fully bonded within hours. Excellent cold weather performance. Makes an excellent compression tape.
- Excellent for sealing ends of firesleeve: prevents sleeve from absorbing contamination and wicking liquids. Excellent for wrapping electrical & mechanical connections and splices. Makes clean and neat installations of cables, wires and hoses. Makes an instant separation bumper and provides vibration dampening. Used as a backshell clamp bushing tape.
- Meets Mil-I-46852 / A-A-59163 and other proprietary specifications.
- CofC available.

<b>MS70T09-S / NSN 5970-00-955-9976 Silicone Rubber Self Fusing Compression/Stretch Electrical Insulating Tape</b>			
<b>Part Number</b>	<b>Tape Width Inches / mm</b>	<b>Tape Thickness</b>	<b>Price Per Roll</b>
T-SR-MS70T09S-NSN-00-955-9976	As per specification	As per specification	\$ 37.91

- Standard roll length is 36 feet / 12 Yards / 10.9 Metres; other lengths available.
- This tape is Black per the specification.

These tapes are guaranteed to meet specification for 1 year from date of manufacture providing tapes are stored dry at 21°C +/- 3°C or 70°F +/- 5°F. Standard tapes have an interleaved liner of polyethylene. Polyester liner available.

**3M™ Scotch® 70 & 70HDT Equivalent Silicone Rubber Electrical Tape**  
**356°F / 180°C: FlameShield™ Meets A-A-59163 & Many Other OEM Specifications**  
**Self Binding Self-Fusing Tape - High Temperature, Heat & Flame Resistant**

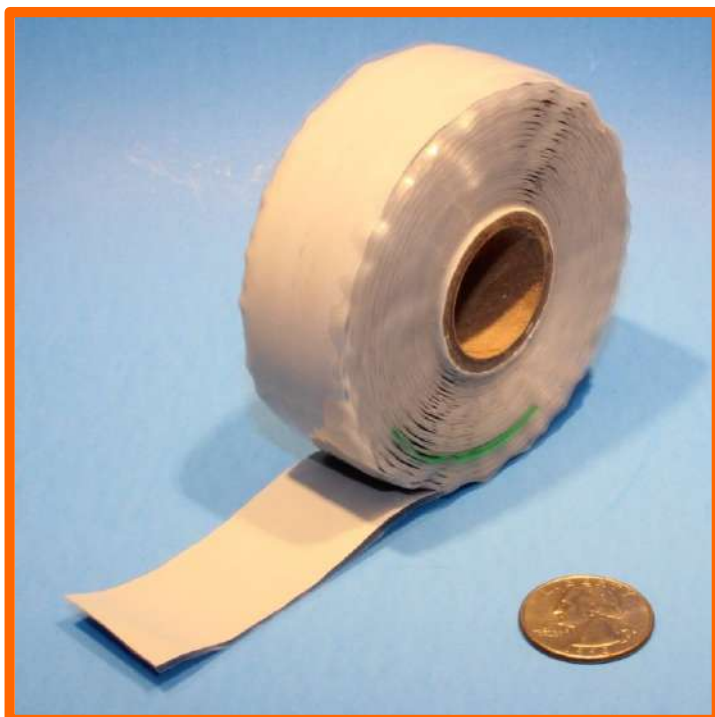

- Self-bonds / self fuses / self amalgamating. No sticky residue or adhesive when removed. Starts fusing within minutes, fully bonded within hours. Excellent cold weather performance. Makes an excellent compression tape.
- Excellent for wrapping electrical & mechanical connections and splices. Makes clean and neat installations of cables, wires and hoses. Makes an instant separation bumper and provides vibration dampening.
- Meets A-A-59163 specifications. CofC available.
- Arc and Track Resistant.
- RoHS compliant.
- Roll length is 30 feet.
- Available as NSN 5970-01-592-3238 & 5970-01-276-5277

FlameShield™ High Temperature Silicone Self Fusing Compression/Stretch Tape Equivalent to 3M™ Scotch® 70 & 70HDT Meets A-A-59163 Specifications					
Part Number	Tape Width Inches / mm	Thickness inches / mm	Profile	Color	Single Roll Price Per Roll
T-SR-3M70	1 / 25	0.012 / 0.30	Rectangular	Blue-Grey	\$ 31.88
T-SR-3M70HDT	1 / 25	0.020 / 0.51	Triangular	Blue-Grey	\$ 33.80

Quantity discounts available – 24 rolls per case

Please enquire for pricing on sizes other than those listed above.

This tape can be made in thicknesses from 0.010” to 0.080” and in various widths.

- Add \$6.00 for individual roll CofC. Lot/Batch CofC \$10.00 per order line item

3M70: 3M ID 80611438617 UPC# 00051128572610  
 3M70HDT: 3M ID 80611438625 UPC# 00051128572627

Triangular tapes have a center guideline stripe to assist in making 50% overwraps. The triangular profile version tape allows for minimal ridge lines, providing splices and joints with an almost totally smooth surface (prevents snagging when splice pulled through obstructions).

Scotch® is a registered trademark of the 3M company



## GE and EMD Coil Winding Encapsulating Tape – Semi Cured & Uncured Bonding Layers

500°F / 260°C: FlameShield™ Silicone Rubber Meets GE and EMD specifications for traction motors: Many others available

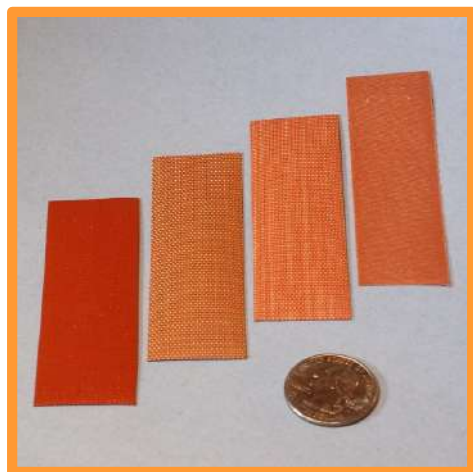

- Available with several construction options:
  - 1) A fiberglass substrate with cured silicone rubber on both sides (one side has a thinner coating layer), with an additional uncured layer on top of the cured layer on one side. Has an interleave.
  - 2) A fiberglass substrate with semi-cured silicone rubber on one side. No interleave.
- Curing: most require a cure cycle of 350F at 50psi for 15 minutes. Post Cure Cycle: 2 to 3 hours at 375-410F. See specific tape data for its curing instructions.
- CofC available.
- Product is produced as a 36" wide log, from which the tape widths are slit. Typical tape widths are 0.75, 1.00, 1.25 and 1.5". Any other width is available. Complete logs available.
- Photo shows a few of the different versions of available tape, with different substrates weave sizes visible through the thin side coating.

FlameShield™ Coil Winding Encapsulating Tape			
Part Number	OEM Part Number	Tape Thickness Inches / mm	Price Per Roll (Depends on Width)
T-SRUC-84	GE 84A210606P154 GE 84A210606P157	0.020 / 0.51	By Quote
T-SRUC-41	GE 41A239176P70 GE 41A239176P71	0.015 / 0.38	By Quote
T-SRUC-82	EMD 8205562 EMD 8227441 EMD R718024	0.015 / 0.38	By Quote
T-SRUC-71	EMD R718051 / EMD R718077 EMD 8220410 / EMD 40100391 EMD 8257527	0.020 / 0.51	By Quote
T-SRUC-21	GE 21261	0.020 / 0.51	By Quote
T-SRUC-158	GE 84A210606P158	0.011 / 0.28	By Quote

- Standard roll length is 36 feet / 12 Yards / 10.9 Metres; other lengths available.
- All versions are Oxide-Red

These tapes are also used to form various flexible structures such as ducting. They can be wrapped over forms and then cured.

## PipeSeal™ Silicone Rubber Self Fusing Compression & Stretch Leak Sealing Tape

### Self-Binding Self-Fusing Tape

Superior method of making drain pipe repairs and septic tank inlet pipe leak repair



- Makes a watertight seal that prevents leaks on drain pipe defects.
- Wide temperature range from -50 to +500F
- Makes Septic Tank Pipe Leak repair quick and easy.
- One roll will wrap ten 4" pipe connections.
- Saves time and money by preventing the need to disassemble pipe assembly.
- Widely used on Septic Tank Inlet Pipe joints and elbows. Many older septic installations did not originally glue the pipes, allowing seepage of the septic liquid into the ground and in contact with basement walls and floor slabs – resulting in a sewer gas smell in the home.



### LeakSeal™ Drain Pipe Leak Repair Tape

Part Number	Tape Width Inches / mm	Tape Thickness	Price Per Roll
T-SR-LeakSeal	1 ½" / 39	.020	\$ 48.77

- Standard roll length is 36 feet / 12 Yards / 10.9 Metres; other lengths available.
- This tape is available Black or Oxide-Red.

## Sealing Tape for Stovepipe and Stainless Steel Flue Gas Duct DuctSeal™ Silicone Rubber Self Fusing Leak Sealing Tape

### Self-Binding Self-Fusing Tape

*Helps to reduce combustion smells by sealing the seams of round duct work on wood stoves, pellet stoves, propane and natural gas stoves and bio-fuel stoves*



- Seals the seams on combustion stove pipe, reduces the smell due to leakage of exhaust flue gas.
- Easy to apply and remove.
- No sticky glue to create a mess and gum up parts.
- Available in Oxide-red or Black.
- Can be applied to hot or cold pipe.
- Wide temperature range from -50 to +500F.
- Popular for use on Simpson M&G DuraVent® and PelletVent® pipe.

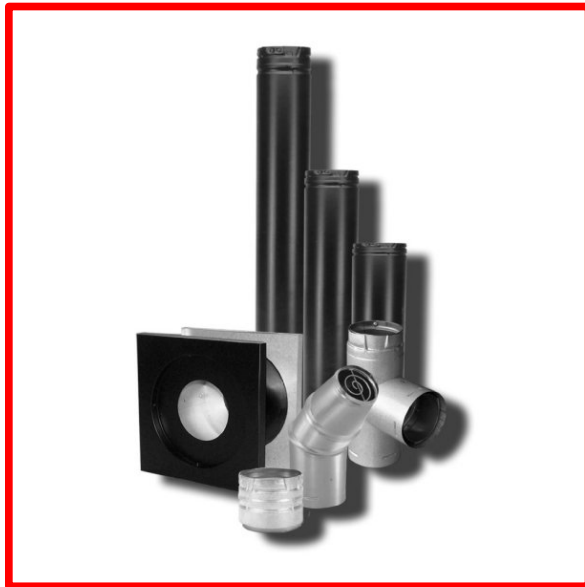

DuctSeal™ Stove Pipe Seam Sealing Tape			
Part Number	Tape Width Inches / mm	Tape Thickness	Price Per Roll
T-SR-DuctSeal	1" / 25	.020	\$ 33.80

- Standard roll length is 36 feet / 12 Yards / 10.9 Metres; other lengths available.
- This tape is available Black or Oxide-Red.

## Fiberglass Gasket Seal Tape with soft PTFE Coating: Premium Grade 550°F / 287°C: Tuff-Flex™ High Temperature, Heat & Chemical Resistance



- An excellent gasket tape providing sealing against a variety of gases and liquids: Excellent chemical resistance.
- Available in three thicknesses.
- PTFE Sintered Coating.

This tape offers the advantage of a non-asbestos material with higher temperature range and with excellent resistance to almost all solvents, caustics and acids. The base fabric is rated to 1000°F / 537°C. PTFE melting point is 620°F / 327°C.

Offered in Plain and Drop Warp (also known as Bolt-Hole or Ladder Tape).

The PTFE is applied to the tape by proprietary sinterization process. The result is a PTFE coating on the tape which is soft, robust and flexible; however, it can be abrasively removed from the tape with aggressive fingernail scraping, resulting in a thinner and thinner layer of PTFE remaining with each pass. The PTFE also causes the yarns to be sealed and the small gaps between the yarns filled, resulting in an almost air-tight / liquid-tight tape.

**Fiberglass Gasket Seal Tape with soft PTFE Coating: Premium Grade**  
**550°F / 287°C: Tuff-Flex™ High Temperature, Heat & Chemical Resistance**



550°F / 287°C continuous rating

High Temperature, Heat & Chemical Resistance Fiberglass Gasket Tape with PTFE Coating: Premium Tape					
Part Number	Width in / mm		Price per Roll By Thickness: A / B / C		
			"A" thickness 1/16" .0625"/1.59mm	"B" thickness 1/8" .125"/3.18mm	"C" thickness 1/4" .250"/6.35mm
T-FG-WOVEN-PTFE-P-M013-08-X-Z**	.5	13	\$ 76.41	\$ 118.66	NA
T-FG-WOVEN-PTFE-P-M019-12-X-Z**	.75	19	\$ 81.59	\$ 131.66	\$ 249.91
T-FG-WOVEN-PTFE-P-M025-16-X-Z	1.0	25	\$ 131.59	\$ 207.21	\$ 378.98
T-FG-WOVEN-PTFE-P-M032-20-X-Z	1.25	32	\$ 184.02	\$ 284.98	\$ 498.56
T-FG-WOVEN-PTFE-P-M038-24-X-Z	1.5	38	\$ 235.58	\$ 361.25	\$ 621.18
T-FG-WOVEN-PTFE-P-M051-32-X-Z	2.0	51	\$ 297.57	\$ 457.61	\$ 779.41
T-FG-WOVEN-PTFE-P-M064-40-X-Z	2.5	64	\$ 359.56	\$ 556.95	\$ 906.18
T-FG-WOVEN-PTFE-P-M076-48-X-Z	3.0	76	\$ 411.12	\$ 638.79	\$ 1062.32
T-FG-WOVEN-PTFE-P-M089-56-X-Z	3.5	89	\$ 451.86	\$ 703.48	\$ 1197.57*
T-FG-WOVEN-PTFE-P-M102-64-X-Z	4.0	102	\$ 509.60	\$ 794.73	\$ 1356.91
T-FG-WOVEN-PTFE-P-M127-80-X-Z	5.0	127	\$ 640.86	\$ 993.06	\$ 1677.31*
T-FG-WOVEN-PTFE-P-M152-96-X-Z	6.0	152	\$ 757.01	\$ 1191.02	\$ 2043.09

- For the "X" value, specify "A", "B" or "C" in the part number to correspond to the desired thickness: A = 1/16" / .0625" / 1.59mm B = 1/8" / .125" / 3.18mm C = 1/4" / .250" / 6.35mm
- For the "Z" value in part number: use "-P" for Plain style tape or "-DW" for Drop Warp style tape
- All tapes are 100 foot lengths.
- Items with \* may have higher minimum order quantities – please call.
- \*\* .5" / 13mm and .75" / 19mm width tapes are not available in Drop Warp



## Fiberglass Gasket Seal Tape with PTFE Coating: Industrial Grade 550°F / 287°C: Tuff-Flex™ High Temperature, Heat & Chemical Resistance



- An excellent gasket tape providing sealing against a variety of gases and liquids: Excellent chemical resistance.
- Available in two thicknesses.
- PTFE Sintered Coating

This tape offers the advantage of a non-asbestos material with higher temperature range and with excellent resistance to almost all solvents, caustics and acids. The base fabric is rated to 1000°F / 537°C. PTFE melting point is 620°F / 327°C.

Offered in Plain and Drop Warp (also known as Bolt-Hole or Ladder Tape).

550°F / 287°C continuous rating

High Temperature, Heat & Chemical Resistance Fiberglass Gasket Tape with PTFE Coating: Industrial Tape				
Part Number	Width in / mm		Price per Roll By Thickness: A / B	
			"A" thickness 1/16" .0625"/1.59mm	"B" thickness 1/8" .125"/3.18mm
T-FG-WOVEN-PTFE-I-M013-08-X-Z**	.5	13	\$ 270.41** / #	\$ 186.50**
T-FG-WOVEN-PTFE-I-M019-12-X-Z**	.75	19	\$ 104.34**	\$ 305.75 ** / ***
T-FG-WOVEN-PTFE-I-M025-16-X-Z	1.0	25	\$ 119.66	\$ 193.00
T-FG-WOVEN-PTFE-I-M032-20-X-Z	1.25	32	\$ 143.84	\$ 219.00
T-FG-WOVEN-PTFE-I-M038-24-X-Z	1.5	38	\$ 149.21	\$ 227.32
T-FG-WOVEN-PTFE-I-M051-32-X-Z	2.0	51	\$ 171.66	\$ 252.50
T-FG-WOVEN-PTFE-I-M064-40-X-Z	2.5	64	\$ 243.16	\$ 326.74
T-FG-WOVEN-PTFE-I-M076-48-X-Z	3.0	76	\$ 264.21	\$ 331.84
T-FG-WOVEN-PTFE-I-M089-56-X-Z	3.5	89	\$ 291.50	\$ 367.52
T-FG-WOVEN-PTFE-I-M102-64-X-Z	4.0	102	\$ 319.16	\$ 403.11
T-FG-WOVEN-PTFE-I-M127-80-X-Z	5.0	127	\$ 399.32	\$ 469.41
T-FG-WOVEN-PTFE-I-M152-96-X-Z	6.0	152	\$ 417.66	\$ 543.71

- For the "X" value specify "A" or "B" in the part number to correspond to the desired thickness  
A = 1/16" / .0625" / 1.59mm B = 1/8" / .125" / 3.18mm
- For the "Z" value in part number: use "-P" for Plain style tape or "-DW" for Drop Warp style tape
- All tapes are 100 foot lengths.
- Items with \* may have higher minimum order quantities – please call.
- \*\* .5" / 13mm and .75" / 19mm width tapes are not available in Drop Warp. \*\*\* 200 ft long
- # .5" / 13mm wide x 1/16" thick tape is 500 ft roll length

The PTFE is applied to the tape by proprietary sinterization process. The result is a PTFE coating on the tape which is soft, robust and flexible; however, it can be abrasively removed from the tape with aggressive fingernail scraping, resulting in a thinner and thinner layer of PTFE remaining with each pass. The PTFE also causes the yarns to be sealed and the small gaps between the yarns filled, resulting in an almost air-tight / liquid-tight tape.

## Fiberglass Tape with PTFE Resin Impregnation & Self Adhesive 500°F / 260°C: Tuff-Flex™ High Temperature & Chemical Resistant with Smooth Non-Stick Surface - Premium Grade & Industrial Grade



- This tape is made by slitting our PTFE resin impregnated fiberglass fabric. Available with and without backing media on the adhesive side. Available with Acrylic or Silicone adhesive.
- Provides excellent chemical resistance and superior electrical insulation. Used as a low friction release tape for heat sealing bars and other packaging applications.
- Used on various machinery parts to provide a smooth stick-free surface such as on production line runners and guides for easy product and parts conveyance.
- Used as an electrical tape for high insulation and high temperature performance.
- Premium Grade is an exceptionally smooth surface with a higher PTFE content than Industrial Grade.
- Temperature range: Silicone adhesive tape -100°F to +500°F (-73°C to +260°C). Acrylic adhesive tapes -40°F to +350°F (-40°C to +177°C).

**Fiberglass Tape with PTFE Resin Impregnation & Self Adhesive (Continued)**  
**500°F / 260°C: Tuff-Flex™ High Temperature & Chemical Resistant with Smooth Non-Stick Surface - Premium Grade & Industrial Grade**



Tuff-Flex™ High Temperature, Heat & Chemical Resistant Fiberglass Tape with PTFE Resin Impregnation & Self Adhesive: Premium Grade						
Part Number	Width in / mm		Price per Roll by Thickness Silicone or Acrylic Adhesive ( thickness measurement does not include adhesive )			
			X = 3 .003" Dielectric S = 5 kV / A = 4.5 kV	X = 5 .005" Dielectric S = 7.5 kV / A = 7 kV	X = 6 .006" Dielectric S = 8.5 kV / A = 8.5 kV	X = 10 .010" Dielectric S = 9.5 kV / A = 9 kV
T-FG-PTRI-P-M013-08-X-Y-Z	.5	13	\$ 28.26 *	\$ 39.71 *	\$ 45.07 *	\$ 53.03 *
T-FG-PTRI-P-M019-12-X-Y-Z	.75	19	\$ 42.40 *	\$ 59.57 *	\$ 67.61 *	\$ 79.55 *
T-FG-PTRI-P-M025-16-X-Y-Z	1.0	25	\$ 56.52 *	\$ 79.42 *	\$ 90.14	\$ 106.06
T-FG-PTRI-P-M032-20-X-Y-Z	1.25	32	\$ 70.66	\$ 99.28	\$ 112.68	\$ 132.58
T-FG-PTRI-P-M038-24-X-Y-Z	1.5	38	\$ 84.78	\$ 119.12	\$ 135.22	\$ 159.08
T-FG-PTRI-P-M051-32-X-Y-Z	2.0	51	\$ 113.04	\$ 158.83	\$ 180.29	\$ 212.11
T-FG-PTRI-P-M064-40-X-Y-Z	2.5	64	\$ 141.30	\$ 198.54	\$ 225.36	\$ 265.14
T-FG-PTRI-P-M076-48-X-Y-Z	3.0	76	\$ 169.56	\$ 238.25	\$ 270.43	\$ 318.17
Other Widths			\$ 56.52 / in	\$ 79.42 / in	\$ 90.14 / in	\$ 106.06 / in
Tensile Strength Warp / Fill (lbs/in)	Silicone		95 / 55	140 / 130	150 / 115	325 / 235
	Acrylic		95 / 55	125 / 130	150 / 150	325 / 235
Tear Strength Warp / Fill (lbs/in)	Silicone		1.5 / 0.9	2.2 / 1.7	2.1 / 1.8	7.5 / 4.0
	Acrylic		1.5 / 0.9	1.8 / 1.7	2.1 / 1.7	7.5 / 4.0

\* **NOTE: Minimum order for indicated tapes is 2 rolls** Custom slitting available up to a maximum of 36 inches.

- For the "X" value in the part number, use "3" for .003, "5" for .005, "6" for .006, "10" for .010, "14" for .014
- For the "Y" value specify "A" or "S" in the part number to correspond to the desired adhesive  
A = Acrylic S = Silicone
- For the "Z" value in part number: use "BP" to order with backing media or "NP" for no backing media  
Silicone backing paper is yellow, acrylic backing paper is blue. Same price with or without backing.
- All tapes are 36 yards. 18 yard rolls are available at -30% of the price shown.
- Adhesive thickness of Acrylic is .002". Silicone adhesive is .0022" thick for .003 & .005 tape and .0030" thick for all others.

The PTFE resin is applied to the base fabric in a hot process and under pressure, causing a total impregnation of the base fabric. The surface of the resin is smooth and it takes considerable and aggressive force to scratch the PTFE surface to remove it from the fabric with fingernail scraping.

**Fiberglass Tape with PTFE Resin Impregnation & Self Adhesive (Continued)**  
**500°F / 260°C: Tuff-Flex™ High Temperature & Chemical Resistant with Smooth Non-Stick Surface - Industrial Grade**



Tuff-Flex™ High Temperature, Heat & Chemical Resistant Fiberglass Tape with PTFE Resin Impregnation & Self Adhesive: Industrial Grade							
Part Number	Width in / mm		Price per Roll by Thickness Silicone or Acrylic Adhesive ( thickness measurement does not include adhesive )				
			X = 3 .003"	X = 5 .005"	X = 6 .006"	X = 10 .010"	X = 14 .014" *
			Dielectric S = 5 kV / A = 5 kV	Dielectric S = 6 kV / A = 6 kV	Dielectric S = 8 kV / A = 8 kV	Dielectric S = 9.5 kV / A = 8.5 kV	Dielectric S = 10.5 kV / A = 9 kV
T-FG-PTRI-I-M013-08-X-Y-Z	.5	13	\$ 23.55 *	\$ 33.09 *	\$ 37.56 *	\$ 44.19 *	\$ 67.80 *
T-FG-PTRI-I-M019-12-X-Y-Z	.75	19	\$ 35.33 *	\$ 49.64 *	\$ 56.34 *	\$ 66.29 *	\$ 101.70
T-FG-PTRI-I-M025-16-X-Y-Z	1.0	25	\$ 47.10 *	\$ 66.18 *	\$ 75.12 *	\$ 88.38	\$ 135.60
T-FG-PTRI-I-M032-20-X-Y-Z	1.25	32	\$ 58.88	\$ 82.73	\$ 93.90	\$ 110.48	\$ 169.50
T-FG-PTRI-I-M038-24-X-Y-Z	1.5	38	\$ 70.65	\$ 99.27	\$ 112.68	\$ 132.57	\$ 203.40
T-FG-PTRI-I-M051-32-X-Y-Z	2.0	51	\$ 94.20	\$ 132.36	\$ 150.24	\$ 176.76	\$ 271.20
T-FG-PTRI-I-M064-40-X-Y-Z	2.5	64	\$ 117.75	\$ 165.45	\$ 187.80	\$ 220.95	\$ 339.00
T-FG-PTRI-I-M076-48-X-Y-Z	3.0	76	\$ 141.30	\$ 198.54	\$ 225.36	\$ 265.14	\$ 406.80
Other Widths			\$ 47.10 / in	\$ 66.18 / in	\$ 75.12 / in	\$ 88.38 / in	\$ 135.60 / in
Tensile Strength Warp / Fill (lbs/in)	Silicone		100 / 50	135 / 120	150 / 140	250 / 155	440 / 250
	Acrylic		90 / 50	135 / 120	150 / 140	250 / 155	440 / 250
Tear Strength Warp / Fill (lbs/in)	Silicone		1.7 / 0.9	2.3 / 1.5	2.0 / 1.5	4.9 / 3.0	7.0 / 5.0
	Acrylic		1.7 / 0.9	1.8 / 1.5	2.0 / 1.5	6.0 / 3.0	7.0 / 5.0

**\*Note: Minimum order for indicated tapes is 2 rolls** Custom slitting available up to a maximum of 36 inches.

- For the "X" value in the part number, use "3" for .003, "5" for .005, "6" for .006, "10" for .010, "14" for .014
- For the "Y" value specify "A" or "S" in the part number to correspond to the desired adhesive  
A = Acrylic S = Silicone
- For the "Z" value in part number: use "BP" to order with backing media or "NP" for no backing media  
Silicone backing paper is yellow, acrylic backing paper is blue. Same price with or without backing.
- All tapes are 36 yards. 18 yard rolls are available at -30% of the price shown.
- Adhesive thickness of Acrylic is .002". Silicone adhesive is .0022" thick for .003 & .005 tape and .0030" thick for all others.

The PTFE resin is applied to the fabric in a hot process and under pressure, causing a total impregnation of the base fabric. The surface of the resin is smooth and it takes considerable and aggressive force to scratch the ptfе surface to remove it from the fabric with fingernail scraping.

## Skived PTFE Tape with Self Adhesive 590°F / 310°C: Tuff-Flex™ High Temperature & Chemical Resistance with Ultra Smooth Non-Stick Surface



- High elongation provides excellent conformability around splices and connectors.
- Available with and without backing strip.
- Available with Acrylic or Silicone adhesive
- Providing excellent chemical resistance and superior electrical insulation. Used as a low friction release tape for heat sealing and other packaging applications.
- Used on various machinery parts to provide a smooth stick-free surface such as on production line runners, rollers and guides for easy product and parts conveyance.
- Used as an electrical tape for high insulation and high temperature performance. 2540v/mil dielectric breakdown (minimum).
- Used for splicing of PTFE coated wiring and for forming watertight seals around blasting cap and detonating cord, lap splicing of firing cable (mining & underwater demolition).

Tuff-Flex™ High Temperature, Heat & Chemical Resistance Skived PTFE Tape with Self Adhesive					
Part Number	Width in / mm		Price per Roll by Thickness ( thickness measurement does not include adhesive )		
			X = 3 .003"	X = 5 .005"	X = 10 .010"
T-PT-SK-M013-08-X-Y-Z	.5	13	\$ 25.25	\$ 30.53	\$ 46.38
T-PT-SK-M019-12-X-Y-Z	.75	19	\$ 37.87	\$ 45.79	\$ 69.57
T-PT-SK-M025-16-X-Y-Z	1.0	25	\$ 50.49	\$ 61.05	\$ 92.76
T-PT-SK-M032-20-X-Y-Z	1.25	32	\$ 63.11	\$ 76.31	\$ 115.95
T-PT-SK-M038-24-X-Y-Z	1.5	38	\$ 75.74	\$ 91.56	\$ 139.14
T-PT-SK-M051-32-X-Y-Z	2.0	51	\$ 100.98	\$ 122.10	\$ 185.52
T-PT-SK-M064-40-X-Y-Z	2.5	64	\$ 126.22	\$ 152.63	\$ 231.90
T-PT-SK-M076-48-X-Y-Z	3.0	76	\$ 151.47	\$ 183.15	\$ 278.28
Other Widths			\$ 50.49 / inch	\$ 61.05 / inch	\$ 92.76 / inch

Price is for tape with Silicone adhesive. For Acrylic adhesive subtract 5% from price shown

Custom slitting to any width is available up to a maximum of 36 inches. Sold in full rolls only.

- **For the "X" value**, specify "3" for .003" thickness, "5" for .005" thickness, "10" for .010" thickness
- **For the "Y" value**, specify "A" or "S" in the part number to correspond to the desired adhesive  
A = Acrylic S = Silicone
- **For the "Z" value**, use "BP" for with Backing Paper or "NP" for no backing paper  
Silicone backing paper is yellow, acrylic backing paper is blue. Same price with or without backing.
- All tapes are 36 yards. 18 yard rolls are available at 70% of the price shown.
- Adhesive thickness of Acrylic is .002". Silicone adhesive is .0022" thick.



## Skived PTFE Tape with Self Adhesive - High Modulus 590°F / 310°C: Tuff-Flex™ High Temperature & Chemical Resistance with Ultra Smooth Non-Stick Surface



- Low elongation and high wear properties.
- Designed for heat sealing, wire wrapping and electrical insulation for electrical component manufacturing such as coils, capacitors and transformers.
- Available with and without backing strip.
- Silicone adhesive
- Providing excellent chemical resistance and superior electrical insulation. Used as a low friction release tape for heat sealing and other packaging applications.
- Used on various machinery parts to provide a smooth stick-free surface such as on production line runners, rollers and guides for easy product and parts conveyance.
- Used as an electrical tape for high insulation and high temperature performance. 2540v/mil dielectric breakdown (minimum).
- Used for splicing of PTFE coated wiring and for forming watertight seals around blasting cap and detonating cord, lap splicing of firing cable (mining & underwater demolition).
- Equivalent to Saint Gobain 2255-2 tape.

### Tuff-Flex™ High Temperature, Heat & Chemical Resistance Skived PTFE Tape with Self Adhesive - High Modulus

Part Number	Width in / mm		Price per Roll by Thickness ( thickness measurement does not include adhesive )		
			X = 2 .002"	X = 3 .003"	X = 5 .005"
			T-PT-SK-HM-M013-08-X-Z	.5	13
T-PT-SK-HM-M019-12-X-Z	.75	19	\$ 59.40	\$ 64.58	\$ 93.98
T-PT-SK-HM-M025-16-X-Z	1.0	25	\$ 79.20	\$ 86.10	\$ 125.31
T-PT-SK-HM-M032-20-X-Z	1.25	32	\$ 99.00	\$ 107.63	\$ 156.64
T-PT-SK-HM-M038-24-X-Z	1.5	38	\$ 118.80	\$ 129.15	\$ 187.96
T-PT-SK-HM-M051-32-X-Z	2.0	51	\$ 158.40	\$ 172.20	\$ 250.62
T-PT-SK-HM-M064-40-X-Z	2.5	64	\$ 198.00	\$ 215.25	\$ 313.28
T-PT-SK-HM-M076-48-X-Z	3.0	76	\$ 237.60	\$ 258.30	\$ 375.93
Other Widths			\$ 79.20 / inch	\$ 86.10 / inch	\$ 125.31 / inch

Price is for tape with Silicone adhesive.

Custom slitting to any width is available up to a maximum of 36 inches. Sold in full rolls only.

- **For the "X" value**, specify "2" for .002" thickness, "3" for .003" thickness, "5" for .005" thickness
- **For the "Z" value**, use "BP" for with Backing Paper or "NP" for no backing paper  
Silicone backing paper is yellow, acrylic backing paper is blue. Same price with or without backing.
- All tapes are 36 yards. 18 yard rolls are available at 70% of the price shown.
- Silicone adhesive is .0022" thick.

**MIL-I-23594C / A-A-59474 Skived PTFE Tape with Self Adhesive**  
**590°F / 310°C: Tuff-Flex™ High Temperature & Chemical Resistance with Ultra Smooth Non-Stick Surface. Type 1 Class 2 and Type 1 Class 4**



- High elongation provides excellent conformability around splices and connectors.
- One side is coated with Silicone high temperature adhesive
- Providing excellent chemical resistance and superior electrical insulation. Used as a low friction release tape for heat sealing and other packaging applications.
- Used on various machinery parts to provide a smooth stick-free surface such as on production line runners, rollers and guides for easy product and parts conveyance.
- Used as an electrical tape for high insulation and high temperature performance. 2540v/mil dielectric breakdown (minimum).
- Used for splicing of PTFE coated wiring and for forming watertight seals around blasting cap and detonating cord, lap splicing of firing cable (mining & underwater demolition).

<b>MIL-I-23594C / A-A-59474 Skived PTFE Electrical Tape with Self Adhesive</b>				
<b>High Temperature, Heat &amp; Chemical Resistance</b>				
Part Number	Width in / mm		Price per Roll by Thickness ( thickness measurement does not include adhesive )	
			X = 3 .003" T1C2	X = 5 .005" T1C4
T-AA59474-MILI23594-0.500-X	.5	13	\$ 32.62	\$ 38.67
T-AA59474-MILI23594-0.750-X	.75	19	\$ 49.67	\$ 58.00
T-AA59474-MILI23594-1.000-X	1.0	25	\$ 65.23	\$ 77.34
T-AA59474-MILI23594-1.250-X	1.25	32	\$ 81.54	\$ 96.68
T-AA59474-MILI23594-1.500-X	1.5	38	\$ 97.85	\$ 116.01
T-AA59474-MILI23594-2.000-X	2.0	51	\$ 130.46	\$ 154.68
T-AA59474-MILI23594-2.500-X	2.5	64	\$ 163.07	\$ 193.35
T-AA59474-MILI23594-3.000-X	3.0	76	\$ 195.69	\$ 232.02
Other Widths			\$ 65.23 / inch	\$ 77.34 / inch

Custom slitting to any width is available up to a maximum of 36 inches. Sold in full rolls only. Roll length 108 feet

- For the "X" value, specify "3" for .003" thickness, "5" for .005" thickness
- Adhesive thickness is .0022" thick.



## Tuff-Flex™ Expanded PTFE Joint Seal Tape

### 550°F / 287°C: High Temperature & Chemical Resistance



- Made from ePTFE

Pure ePTFE joint seal tape with an adhesive backing makes a superb cord formed gasket for use as a jointing on all types of flanges. Excellent corrosion resistance, high pressure resistance, easy to use, soft and is ideal for enamel, glass, and especially rough and special shaped sealing.

Excellent resistance to almost all solvents, caustics and acids.

PTFE melting point is 620°F / 327°C.

- PH Range: 0 to 14
- Maximum tensile: 4260 psi (30Mpa)
- Temperature Range: -500F / -268C to +500F / +260C
- Pressure Limits: 2900 psi / 200 kgf/cm2 (20Mpa)

550°F / 287°C continuous rating

This is a high-performance ePTFE used in almost all industries for its heat protection & Chemical Resistance.

Tuff-Flex™ High Temperature, Heat & Chemical Resistance ePTFE Joint Seal					
Part Number	Dimension Width (inch) / Length (feet) / Thickness (inch)	Price per spool	Part Number	Dimension Width (inch) / Length (feet) / Thickness (inch)	Price per spool
T-PT-JS-125-100	.125" / 100' / 0.10"	\$ 103.47	T-PT-JS-500-15	.500" / 15' / 0.21"	\$ 84.70
T-PT-JS-125-500	.125" / 500' / 0.10"	\$ 387.50	T-PT-JS-500-30	.500" / 30' / 0.21"	\$ 129.43
T-PT-JS-187-75	.187" / 75' / 0.10"	\$ 104.47	T-PT-JS-500-150	.500" / 150' / 0.21"	\$ 576.33
T-PT-JS-187-500	.187" / 500' / 0.10"	\$ 507.33	T-PT-JS-625-15	.625" / 15' / 0.23"	\$ 96.30
T-PT-JS-250-50	.250" / 50' / 0.10"	\$ 100.47	T-PT-JS-625-30	.625" / 30' / 0.23"	\$ 192.43
T-PT-JS-250-100	.250" / 100' / 0.10"	\$ 197.90	T-PT-JS-625-150	.625" / 150' / 0.23"	\$ 873.25
T-PT-JS-250-250	.250" / 250' / 0.10"	\$ 376.50	T-PT-JS-750-15	.750" / 15' / 0.25"	\$ 147.67
T-PT-JS-250-500	.250" / 500' / 0.10"	\$ 749.00	T-PT-JS-750-30	.750" / 30' / 0.25"	\$ 295.20
T-PT-JS-375-25	.375" / 25' / 0.17"	\$ 79.70	T-PT-JS-750-100	.750" / 100' / 0.25"	\$ 939.20
T-PT-JS-375-50	.375" / 50' / 0.17"	\$ 149.43	T-PT-JS-1000-15	1.000" / 15' / 0.30"	\$ 221.35
T-PT-JS-375-250	.375" / 250' / 0.17"	\$ 576.33	T-PT-JS-1000-30	1.000" / 30' / 0.30"	\$ 442.73
			T-PT-JS-1000-75	1.000" / 75' / 0.30"	\$ 1056.58

\* Note: The PSA will burn off at temperatures above 400°F and should be used to facilitate installation. Material with PSA should not be used in confined areas at elevated temperatures without ventilation until all of the PSA has vaporized.

NOTE: This product is made in round form, then flattened: the width and thickness tolerance is +/- 0.063" for 0.50" wide seal and larger, and +/- 0.031" for 0.375" wide seal and smaller.

**This Product is NOT Available By The Foot**

**Fiberglass Tape with PTFE Resin Impregnation, Non- Adhesive**  
**FDA Food Contact Approved**  
**500°F / 260°C: Tuff-Flex™ High Temperature & Chemical Resistant with Smooth**  
**Non-Stick Surface - Premium Grade**



- This tape is made by slitting our PTFE resin impregnated fiberglass fabric.
- Provides excellent chemical resistance and superior electrical insulation. Used as a low friction release tape for heat sealing bars and other packaging applications.
- Used on various machinery parts to provide a smooth stick-free surface such as on production line runners and guides for easy product and parts conveyance.
- Used as an electrical tape for high insulation and high temperature performance.
- Premium Grade is an exceptionally smooth surface with a higher PTFE content than Industrial Grade.
- Temperature range: -100°F to +500°F (-73°C to +260°C).

Tuff-Flex™ High Temperature, Heat & Chemical Resistant Fiberglass Tape with PTFE Resin Impregnation: Premium Grade						
Part Number	Width in / mm		Price per Roll by Thickness			
			X = 3 .003" Dielectric S = 5 kV / A = 4.5 kV	X = 5 .005" Dielectric S = 7.5 kV / A = 7 kV	X = 6 .006" Dielectric S = 8.5 kV / A = 8.5 kV	X = 10 .010" Dielectric S = 9.5 kV / A = 9 kV
T-FG-PTRI-FDA-P-M013-08-X	.5	13	\$ 28.26 *	\$ 39.71 *	\$ 45.07 *	\$ 53.03 *
T-FG-PTRI-FDA-P-M019-12-X	.75	19	\$ 42.40 *	\$ 59.57 *	\$ 67.61 *	\$ 79.55 *
T-FG-PTRI-FDA-P-M025-16-X	1.0	25	\$ 56.52 *	\$ 79.42 *	\$ 90.14	\$ 106.06
T-FG-PTRI-FDA-P-M032-20-X	1.25	32	\$ 70.66	\$ 99.28	\$ 112.68	\$ 132.58
T-FG-PTRI-FDA-P-M038-24-X	1.5	38	\$ 84.78	\$ 119.12	\$ 135.22	\$ 159.08
T-FG-PTRI-FDA-P-M051-32-X	2.0	51	\$ 113.04	\$ 158.83	\$ 180.29	\$ 212.11
T-FG-PTRI-FDA-P-M064-40-X	2.5	64	\$ 141.30	\$ 198.54	\$ 225.36	\$ 265.14
T-FG-PTRI-FDA-P-M076-48-X	3.0	76	\$ 169.56	\$ 238.25	\$ 270.43	\$ 318.17
Other Widths			\$ 56.52 / in	\$ 79.42 / in	\$ 90.14 / in	\$ 106.06 / in
Tensile Strength Warp / Fill (lbs/in)			95 / 55	140 / 130	150 / 115	325 / 235
Tear Strength Warp / Fill (lbs/in)			1.5 / 0.9	2.2 / 1.7	2.1 / 1.8	7.5 / 4.0

\* NOTE: Minimum order for indicated tapes is 2 rolls Custom slitting available up to a maximum of 36 inches.

- For the "X" value in the part number, use "3" for .003, "5" for .005, "6" for .006, "10" for .010, "14" for .014
- All tapes are 36 yards. 18 yard rolls are available at -30% of the price shown.

The PTFE resin is applied to the base fabric in a hot process and under pressure, causing a total impregnation of the base fabric. The surface of the resin is smooth and it takes considerable and aggressive force to scratch the PTFE surface to remove it from the fabric with fingernail scraping.



## Fiberglass Tape with PTFE Resin Impregnation, Non Adhesive FDA Food Contact Approved 500°F / 260°C: Tuff-Flex™ High Temperature & Chemical Resistant with Smooth Non-Stick Surface - Industrial Grade



- This tape is made by slitting our PTFE resin impregnated fiberglass fabric.
- Provides excellent chemical resistance and superior electrical insulation. Used as a low friction release tape for heat sealing and other packaging applications.
- Used on various machinery parts to provide a smooth stick-free surface such as on production line runners and guides for easy product and parts conveyance.
- Used as an electrical tape for high insulation and high temperature performance.
- Industrial Grade is a smooth surface with slight surface texturization (underlying fiberglass weave). Premium Grade is an exceptionally smooth surface with a higher PTFE content than Industrial Grade.
- Temperature range: -100°F to +500°F (-73°C to +260°C).

Tuff-Flex™ High Temperature, Heat & Chemical Resistant Fiberglass Tape with PTFE Resin Impregnation & Self Adhesive: Industrial Grade							
Part Number	Width in / mm		Price per Roll by Thickness				
			X = 3 .003"	X = 5 .005"	X = 6 .006"	X = 10 .010"	X = 14 .014" *
			Dielectric S = 5 kV / A = 5 kV	Dielectric S = 6 kV / A = 6 kV	Dielectric S = 8 kV / A = 8 kV	Dielectric S = 9.5 kV / A = 8.5 kV	Dielectric S = 10.5 kV / A = 9 kV
T-FG-PTRI-FDA-I-M013-08-X	.5	13	\$ 23.55 *	\$ 33.09 *	\$ 37.56 *	\$ 44.19 *	\$ 67.80 *
T-FG-PTRI-FDA-I-M019-12-X	.75	19	\$ 35.33 *	\$ 49.64 *	\$ 56.34 *	\$ 66.29 *	\$ 101.70
T-FG-PTRI-FDA-I-M025-16-X	1.0	25	\$ 47.10 *	\$ 66.18 *	\$ 75.12 *	\$ 88.38	\$ 135.60
T-FG-PTRI-FDA-I-M032-20-X	1.25	32	\$ 58.88	\$ 82.73	\$ 93.90	\$ 110.48	\$ 169.50
T-FG-PTRI-FDA-I-M038-24-X	1.5	38	\$ 70.65	\$ 99.27	\$ 112.68	\$ 132.57	\$ 203.40
T-FG-PTRI-FDA-I-M051-32-X	2.0	51	\$ 94.20	\$ 132.36	\$ 150.24	\$ 176.76	\$ 271.20
T-FG-PTRI-FDA-I-M064-40-X	2.5	64	\$ 117.75	\$ 165.45	\$ 187.80	\$ 220.95	\$ 339.00
T-FG-PTRI-FDA-I-M076-48-X	3.0	76	\$ 141.30	\$ 198.54	\$ 225.36	\$ 265.14	\$ 406.80
Other Widths			\$ 47.10 / in	\$ 66.18 / in	\$ 75.12 / in	\$ 88.38 / in	\$ 135.60 / in
Tensile Strength Warp / Fill (lbs/in)			100 / 50 90 / 50	135 / 120 135 / 120	150 / 140 150 / 140	250 / 155 250 / 155	440 / 250 440 / 250
Tear Strength Warp / Fill (lbs/in)			1.7 / 0.9	2.3 / 1.5	2.0 / 1.5	4.9 / 3.0	7.0 / 5.0

\*Note: Minimum order for indicated tapes is 2 rolls Custom slitting available up to a maximum of 36 inches.

- For the "X" value in the part number, use "3" for .003, "5" for .005, "6" for .006, "10" for .010, "14" for .014
- All tapes are 36 yards. 18 yard rolls are available at -30% of the price shown.

The PTFE resin is applied to the fabric in a hot process and under pressure, causing a total impregnation of the base fabric. The surface of the resin is smooth and it takes considerable and aggressive force to scratch the ptfе surface to remove it from the fabric with tool or fingernail scraping.



## Tacky-Cloth™ White Rubber Coated Fiberglass Gasket Seal Tape 550°F / 287°C: Tuff-Flex™ High Temperature Heat Resistant Tape: *With or Without Wire Insert*



This is a widely used and universal tape for making gaskets, especially where a rough or uneven surface or flange exists. The tape is a fiberglass base with a special white rubber formulation coating. The tape is tacky, and has a plastic film surface covering that is removed before installation. The tape will stick to itself once the film is removed.

**Wire Inserted Version:** The fill (width wise) yarn for this version of the fabric has a twisted brass wired formed with it, providing additional dimensional stability/strength.

550°F / 287°C continuous rating, excellent sealing properties as a gasket material

Tuff-Flex™ High Temperature White Rubber Coated Fiberglass Universal Gasket Tape (Tacky Cloth)						
Part Number	Width in / mm	Price per Foot By Thickness: A / B / C / D / E in / mm				
		"A" thickness .062 / 1.6	"B" thickness .125 / 3.2	"C" thickness .187 / 4.8	"D" thickness .250 / 6.3	"E" thickness .375 / 7.9
T-FG-TC-M013-08-X-Z	.50 / 13	NA	\$ 2.10	\$ 3.12	\$ 4.14	NA
T-FG-TC-M019-12-X-Z	.75 / 19	NA	\$ 2.76	\$ 3.72	\$ 5.16	NA
T-FG-TC-M025-16-X-Z	1.0 / 25	\$ 1.68	\$ 3.30	\$ 4.80	\$ 6.48	\$ 10.32
T-FG-TC-M032-20-X-Z	1.25 / 32	\$ 2.10	\$ 4.08	\$ 6.06	\$ 8.10	\$ 12.47
T-FG-TC-M038-24-X-Z	1.50 / 38	\$ 2.40	\$ 4.80	\$ 7.26	\$ 9.76	\$ 14.94
T-FG-TC-M051-32-X-Z	2.00 / 51	\$ 3.30	\$ 6.48	\$ 9.78	\$ 12.90	\$ 19.44
T-FG-TC-M076-48-X-Z	3.00 / 76	\$ 4.56	\$ 9.12	\$ 13.86	\$ 18.42	\$ 29.16
T-FG-TC-M102-64-X-Z	4.00 / 102	\$ 6.12	\$ 12.30	\$ 18.42	\$ 24.60	\$ 38.82
T-FG-TC-M127-80-X-Z	5.00 / 127	\$ 7.38	\$ 15.30	\$ 22.98	\$ 30.60	\$ 48.66

For the "X" value specify either A, B, C, D, or E  
For the "Z" value, use "W" to specify with wire insert and "N" to specify no wire

With and without Wire Insert – Same Price with Either Option

Standard Rolls of 25 and 50 feet. Other lengths add +25% to price.

Curing: It is recommended that this material be cured in situ. This material must be heated to a minimum of 300°F within 60 minutes, then it must sit at 300°F or higher for 90 minutes for the rubber to fully cure. Do not overtorque the material during this curing time or the rubber will be squeezed off of the base material. If the material is not fully cured, the rubber will drip from the material causing voids. After curing the material can be exposed to a lower operational temperature.

## Tacky Cloth™ Luting & Groove Packing 550°F / 287°C: Tuff-Flex™ High Temperature Heat Resistant, Wire Inserted



- Luting & groove packing.
- Formed square: available rectangular or round.
- Standard 25 and 50 foot lengths.
- Add +25% to the price for non standard lengths.

550°F / 287°C continuous rating, excellent sealing properties as a gasket material

Tuff-Flex™ High Temperature Luting & Groove Packing - Square			
Part Number	Size in / mm	Price per Foot	
		Regular	Graphite Coated
T-FG-TC-LGP-M010-06-X	.375 / 10	\$ 5.70	\$ 11.20
T-FG-TC-LGP-M013-08-X	.500 / 13	\$ 6.43	\$ 11.93
T-FG-TC-LGP-M016-10-X	.625 / 16	\$ 9.37	\$ 14.87
T-FG-TC-LGP-M019-12-X	.750 / 19	\$ 9.90	\$ 15.40
T-FG-TC-LGP-M022-14-X	.875 / 22	\$ 12.47	\$ 17.97
T-FG-TC-LGP-M025-16-X	1.00 / 25	\$ 17.50	\$ 22.97
T-FG-TC-LGP-M029-18-X	1.125 / 29	\$ 19.57	\$ 23.40
T-FG-TC-LGP-M032-20-X	1.250 / 32	\$ 31.93	\$ 37.43
T-FG-TC-LGP-M038-24-X	1.500 / 38	\$ 32.67	\$ 38.16

For the "X" value specify either "R" for Regular, or "GC" for Graphite Coated

Standard Rolls of 25 and 50 feet. Other lengths add +25% to price.

Curing: It is recommended that this material be cured in situ. This material must be heated to a minimum of 300°F within 60 minutes, then it must sit at 300°F or higher for 90 minutes for the rubber to fully cure.

Do not overtorque the material during this curing time or the rubber will be squeezed off of the base material.

If the material is not fully cured, the rubber will drip from the material causing voids. After curing the material can be exposed to a lower operational temperature.

**Woven Fiberglass Ultra Thin Electrical Apparatus Insulating Tape:**  
**Premium Grade**  
**1200°F / 648°C: DeltaGlass™ Very High Temperature & Heat Resistant**



- Woven from filament fiberglass yarns (non texturized), this tape will withstand temperatures up to 1200°F / 648°C in continuous service
- Ultra-Thin .007" / .177 mm thickness.
- Used extensively as an insulating tape in transformers, motors and generators. This tape is a bright white color. Selvaged edge to prevent fraying.
- This tape offers superior insulating properties as well as very low chloride and alkali content.
- Other widths available by custom order.
- Various finishes and treatments available including heat cleaned.
- Roll length 50 yards / 150 feet.

1200°F / 648°C continuous rating, high insulation value

<b>Very High Temperature &amp; Heat Resistant                      Woven Fiberglass Apparatus Tape                      Ultra-Thin: .007" / .177mm thickness</b>			
Part Number	Width in / mm		Price per roll
	T-FG-WOVEN-UT-2.0-M051-007	2.0	
T-FG-WOVEN-UT-3.0-M076-007	3.0	76	\$ 59.30

**Fiberglass Knitted Gasket / Thermal Insulation Tape**  
**1200°F / 648°C: DeltaGlass™ Very High Temperature & Heat Resistant**  
**Plain Tape & Bolt Hole / Drop-Warp / LadderTape™: Premium Grade**

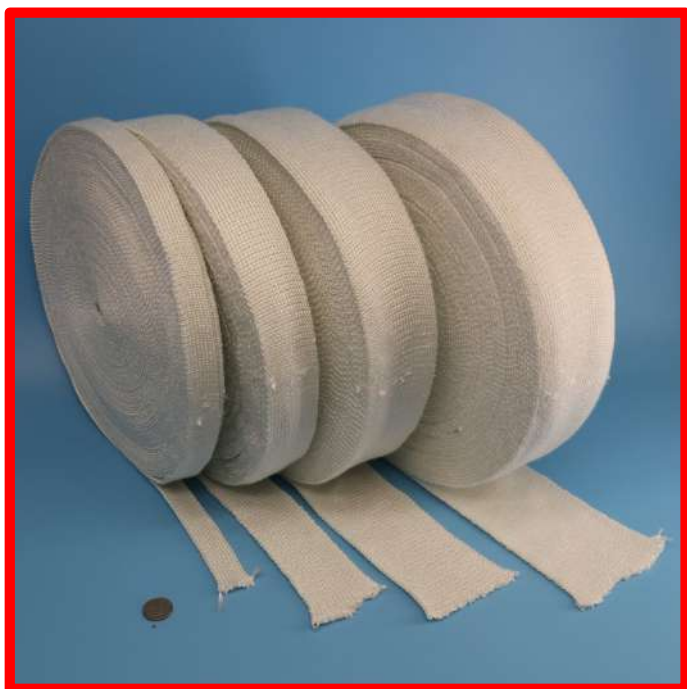

These knitted tapes are fabricated from high quality type E fiberglass that will not burn and will withstand continuous exposure to temperatures of 1200°F / 648°C.

This material resists most acids and alkalis and is unaffected by most bleaches and solvents. It is highly flexible and conformable.

The base fiber is manufactured to the specifications of ASTM D-578, ASTM committee D13, and subcommittee D13.18.

Knitted tapes are extremely flexible and highly conformable, much more so than the same dimension tape in a woven style.

Texturized yarn ensures high bulk and high thermal insulation value.

A Heat Treated version of this product is available – please enquire.

1200°F / 648°C continuous rating, high insulation value & excellent personnel protection

<b>Very High Temperature &amp; Heat Resistant Fiberglass Knitted Tape: Plain &amp; Bolt Hole/Drop-Warp/LadderTape™ - Premium</b>			
<b>1/8" / 3mm Thick Knitted Plain Tape / Drop-Warp - LadderTape™</b>			
<b>Part Number</b>	<b>Width inch / mm</b>		<b>Price per Roll Plain / Drop Warp</b>
T-FG-KNIT-1.000-M025-X	1"	25	\$ 71.67 / \$ 61.67
T-FG-KNIT-1.250-M032-X	1 1/4"	32	\$ 90.00 / \$ 78.33
T-FG-KNIT-1.500-M038-X	1 1/2"	38	\$ 110.00 / \$ 90.00
T-FG-KNIT-1.750-M044-X	1 3/4"	44	\$ 135.00 / \$ 100.00
T-FG-KNIT-2.000-M051-X	2"	51	\$ 156.67 / \$ 110.00
T-FG-KNIT-2.500-M064-X	2 1/2"	64	\$ 180.00 / \$ 133.33
T-FG-KNIT-3.000-M076-X	3"	76	\$ 210.00 / \$ 163.33
T-FG-KNIT-4.000-M102-X	4"	102	\$ 256.67 / \$ 210.00
T-FG-KNIT-5.000-M127-X	5"	127	\$ 306.67 / \$ 260.00

Each roll contains 100 feet / 30 metres.

For the "X" value specify either "P" for Plain Style, or "DW" for Drop Warp (Bolt-Hole / Ladder)

**This Product is NOT Available By-The-Foot – Full Rolls Only**

To aid in mounting this tape onto surfaces, FlangeStik™ pressure sensitive adhesive spray can be used to place the tape in situ temporarily. Permanent fasteners or grab strips should be installed prior to heating of the area sprayed above 200°F. The adhesive will "smoke-off" at elevated temperatures.

**Woven Fiberglass Gasket / Thermal Insulating Tape: *Premium Grade*  
1200°F / 648°C: DeltaGlass™ Very High Temperature & Heat Resistant Plain &  
Drop-Warp (Bolt-Hole / Ladder Tape™)**



Manufactured of texturized fiberglass yarns, this tape will withstand temperatures up to 1200°F / 648°C in continuous service. 100% asbestos free, this tape is a bright white color.

This tape offers superior insulating properties as well as low chloride content.

Offered in *Plain* and *Drop Warp* (also known as *Bolt-Hole* or *LadderTape™*). Drop Warp tape has lengthwise yarns missing from the center of the tape to allow fasteners to pass through the tape for assembly onto access doors, etc.

A Heat Treated version of these tapes is available – add “-HT” to the part number. Price for heat treating is \$6.00 per roll. Heat treated tapes are low smoke, dimensionally set and exceptionally clean of organic content. Tapes are also available with Pressure Sensitive Adhesive (PSA).



## Woven Fiberglass Gasket / Thermal Insulating Tape: Premium Grade (Continued)



Very High Temperature & Heat Resistant Fiberglass Woven Plain & Drop-Warp (Bolt-Hole / LadderTape™) - Premium Grade					
Part Number	Width in / mm		Price per Roll By Thickness		
			"A" thickness Price / Weight (lb)	"B" thickness Price / Weight (lb)	"C" thickness Price / Weight (lb)
T-FG-WOVEN-P-0.500-M013-X-Z**	.5	13	\$ 34.20 / 1.0	\$ 44.43 / 2.2	NA
T-FG-WOVEN-P-0.750-M019-X-Z**	.75	19	\$ 49.60 / 1.6	\$ 55.70 / 3.2	\$ 88.87 / 6.9
T-FG-WOVEN-P-1.000-M025-X-Z	1.0	25	\$ 36.73 / 2.1	\$ 58.44 / 4.2	\$ 128.26 / 9.8
T-FG-WOVEN-P-1.250-M032-X-Z	1.25	32	\$ 38.73 / 2.5	\$ 59.73 / 5.2	\$ 146.83 / 12.6
T-FG-WOVEN-P-1.500-M038-X-Z	1.5	38	\$ 40.13 / 3.0	\$ 60.55 / 6.2	\$ 174.43 / 14.6
T-FG-WOVEN-P-2.000-M051-X-Z	2.0	51	\$ 44.73 / 4.1	\$ 70.80 / 8.2	\$ 188.71 / 19.5
T-FG-WOVEN-P-2.500-M064-X-Z	2.5	64	\$ 49.86 / 5.1	\$ 82.20 / 10.2	\$ 214.66 / 24.4
T-FG-WOVEN-P-3.000-M076-X-Z	3.0	76	\$ 58.23 / 6.2	\$ 99.20 / 12.2	\$ 244.70 / 29.3
T-FG-WOVEN-P-3.500-M089-X-Z	3.5	89	\$ 66.43 / 7.3	\$ 110.86 / 14.2	\$ 286.43 / 34.2
T-FG-WOVEN-P-4.000-M102-X-Z	4.0	102	\$ 75.60 / 8.2	\$ 123.16 / 16.5	\$ 303.16 / 39.0
T-FG-WOVEN-P-4.500-M114-X-Z	4.5	114	\$ 90.77 / 9.2	\$ 163.21 / 18.5	\$ 348.44 / 44.0
T-FG-WOVEN-P-5.000-M127-X-Z	5.0	127	\$ 92.73 / 10.3	\$ 169.93 / 20.5	\$ 379.46 / 48.8
T-FG-WOVEN-P-5.500-M140-X-Z	5.5	140	\$ 96.73 / 11.3	\$ 177.93 / 22.5	\$ 398.46 / 53.7
T-FG-WOVEN-P-6.000-M152-X-Z	6.0	152	\$ 117.03 / 12.3	\$ 187.46 / 24.5	\$ 423.10 / 58.6

- For the "X" Value, specify A, B or C in part number to correspond to the desired thickness  
**A** = 1/16" / .0625" / 1.59mm    **B** = 1/8" / .125" / 3.18mm    **C** = 1/4" / .250" / 6.35mm
- For the "Z" value in part number: use "-P" for Plain style tape or "-DW" for Drop Warp style tape. Same price either version.
- Add "-HT" to the part number for heat treated version. Add \$6.00 to roll price for heat treating.
- All tapes are 100 foot / 30 metre lengths.
- Items with \* may have higher minimum order quantities – please call.
- \*\* -08 / .5" / 13mm and -12 / .75" / 19mm width tapes are not available in Drop Warp
- Heat Treated / Heat Cleaned Available: low smoke – dimensionally set – exceptionally clean

Custom width tapes: Minimum 20 rolls or \$650 setup charge for lower quantities.

**Woven Fiberglass Gasket / Thermal Insulating Tape:  
Premium Grade with PSA Adhesive  
1200°F / 648°C: DeltaGlass™ Very High Temperature & Heat Resistant Plain & Drop  
Warp (Bolt-Hole / Ladder Tape™) with Adhesive PSA**



Manufactured of texturized fiberglass yarns, this tape will withstand temperatures up to 1200°F / 648°C in continuous service. 100% asbestos free, this tape is a bright white color.

This tape offers superior insulating properties as well as low chloride content.

Offered in *Plain* and *Drop Warp* (also known as *Bolt-Hole* or *LadderTape™*). Drop Warp tape has lengthwise yarns missing from the center of the tape to allow fasteners to pass through the tape for assembly onto access doors, etc.

A Heat Treated version of this product is available – please enquire. Also available without Pressure Sensitive Adhesive (PSA) (see previous page in catalog).

1200°F / 648°C continuous rating, high insulation value & excellent personnel protection

Very High Temperature & Heat Resistant Fiberglass Woven Plain & Drop-Warp / Bolt-Hole / LadderTape™ - Premium Grade with PSA Adhesive					
Part Number	Width in / mm		Price per Roll By Thickness		
			"A" thickness Price	"B" thickness Price	"C" thickness Price
T-FG-WOVEN-P-0.500-M013-X-Z-PSA**	.5	13	\$ 77.17	\$ 87.40	NA
T-FG-WOVEN-P-0.750-M019-X-Z-PSA**	.75	19	\$ 83.63	\$ 92.60	\$ 137.03
T-FG-WOVEN-P-1.000-M025-X-Z-PSA	1.0	25	\$ 87.03	\$ 100.23	\$ 178.23
T-FG-WOVEN-P-1.250-M032-X-Z-PSA	1.25	32	\$ 97.88	\$ 117.03	\$ 193.50
T-FG-WOVEN-P-1.500-M038-X-Z-PSA	1.5	38	\$ 100.13	\$ 119.87	\$ 227.77
T-FG-WOVEN-P-2.000-M051-X-Z-PSA	2.0	51	\$ 111.50	\$ 137.27	\$ 252.83
T-FG-WOVEN-P-2.500-M064-X-Z-PSA	2.5	64	\$ 124.87	\$ 157.20	\$ 289.43
T-FG-WOVEN-P-3.000-M076-X-Z-PSA	3.0	76	\$ 139.46	\$ 180.70	\$ 326.36
T-FG-WOVEN-P-3.500-M089-X-Z-PSA	3.5	89	\$ 146.40	\$ 193.86	\$ 381.96
T-FG-WOVEN-P-4.000-M102-X-Z-PSA	4.0	102	\$ 185.46	\$ 216.00	\$ 396.73
T-FG-WOVEN-P-4.500-M114-X-Z-PSA	4.5	114	\$ 191.43	\$ 247.63	\$ 437.71
T-FG-WOVEN-P-5.000-M127-X-Z-PSA	5.0	127	\$ 212.33	\$ 281.20	\$ 491.40
T-FG-WOVEN-P-5.500-M140-X-Z-PSA	5.5	140	\$ 219.33	\$ 288.20	\$ 501.40
T-FG-WOVEN-P-6.000-M152-X-Z-PSA	6.0	152	\$ 227.36	\$ 295.23	\$ 518.20

- For the "X" Value, specify A, B or C in part number to correspond to the desired thickness  
A = 1/16" / .0625" / 1.59mm    B = 1/8" / .125" / 3.18mm    C = 1/4" / .250" / 6.35mm
- For the "Z" value in part number: use "-P" for Plain style tape or "-DW" for Drop Warp style tape. Same price either version.
- All tapes are 100 foot / 30 metre lengths.
- Items with \* may have higher minimum order quantities – please call.
- \*\* -08 / .5" / 13mm and -12 / .75" / 19mm width tapes are not available in Drop Warp
- Heat Treated / Heat Cleaned Available: low smoke – dimensionally set – exceptionally clean

Custom width tapes: Minimum 20 rolls or \$650 setup charge for lower quantities.



## Fiberglass Woven Gasket & Thermal Insulating Tape: *Industrial Grade* 1200°F / 648°C: - Very High Temperature & Heat Resistant Plain & Drop-Warp (Bolt-Hole / Ladder Tape)



Manufactured of texturized fiberglass yarns, tape will withstand temperatures up to 1200°F / 648°C in continuous service.

This tape offers superior insulating properties as well as low chloride content.

Offered in *Plain* and *Drop Warp* (also known as *Bolt-Hole* or *LadderTape™*). Drop Warp tape has lengthwise yarns missing from the center of the tape to allow fasteners to pass through the tape for assembly onto access doors, etc. This is also called a Ladder or Bolthole tape.

A Heat Treated version of this product is available.

Industrial grade tape has a lower bulk than Premium grade (the same size tape weighs more in Premium grade than Industrial grade as it has more fibreglass content). Available with and without Pressure Sensitive Adhesive (PSA).

1200°F / 648°C continuous rating, high insulation value & excellent personnel protection

Very High Temperature & Heat Resistant Fiberglass Woven Plain & Bolt-Hole / Drop-Warp / LadderTape™ - Industrial Grade					
Part Number	Width in / mm		Price per Roll By Thickness: A / B / C		
			"A" thickness no PSA / with PSA	"B" thickness no PSA / with PSA	"C" thickness no PSA / with PSA
T-FG-WOVEN-I-0.500-M013-X-Z**	.5	13	\$ 102.63 / \$ 218.13	\$ 37.30 / \$ 80.26	N/A / NA
T-FG-WOVEN-I-0.750-M019-X-Z**	.75	19	\$ 20.46 / \$ 69.40	\$ 38.74 / \$ 86.22	N/A / NA
T-FG-WOVEN-I-1.000-M025-X-Z	1.0	25	\$ 23.90 / \$ 74.16	\$ 38.56 / \$ 88.43	\$ 57.35 / N/A
T-FG-WOVEN-I-1.250-M032-X-Z	1.25	32	\$ 29.63 / \$ 88.53	\$ 43.80 / \$ 99.20	N/A / NA
T-FG-WOVEN-I-1.500-M038-X-Z	1.5	38	\$ 29.86 / \$ 89.46	\$ 45.48 / \$ 108.06	N/A / NA
T-FG-WOVEN-I-2.000-M051-X-Z	2.0	51	\$ 34.43 / \$ 101.76	\$ 50.50 / \$ 117.83	\$ 67.21 / N/A
T-FG-WOVEN-I-2.500-M064-X-Z	2.5	64	\$ 48.63 / \$ 123.16	\$ 65.80 / \$ 140.96	N/A / NA
T-FG-WOVEN-I-3.000-M076-X-Z	3.0	76	\$ 53.03 / \$ 135.23	\$ 67.10 / \$ 147.50	\$ 84.81 / N/A
T-FG-WOVEN-I-3.500-M089-X-Z	3.5	89	\$ 59.66 / \$ 141.13	\$ 78.66 / \$ 156.13	N/A / NA
T-FG-WOVEN-I-4.000-M102-X-Z	4.0	102	\$ 63.16 / \$ 157.93	\$ 87.76 / \$ 168.53	N/A / NA
T-FG-WOVEN-I-4.500-M114-X-Z	4.5	114	\$ 71.46 / \$ 169.93	\$ 94.51 / \$ 188.79	N/A / NA
T-FG-WOVEN-I-5.000-M127-X-Z	5.0	127	\$ 79.53 / \$ 191.70	\$ 109.80 / \$ 203.96	N/A / NA
T-FG-WOVEN-I-5.500-M140-X-Z	5.5	140	\$ 92.17 / \$ 201.33	\$ 120.27 / \$ 217.31	N/A / NA
T-FG-WOVEN-I-6.000-M152-X-Z	6.0	152	\$ 108.73 / \$ 213.00	\$ 126.36 / \$ 229.63	N/A / NA

- For the "X" value, specify "A" or "B" in part number to correspond to the desired thickness  
**A** = 1/16" / .0625" / 1.59mm    **B** = 1/8" / .125" / 3.18mm    **C** = 1/4" / .250" / 6.35mm
- For "Z" value in part number: use "-P" for Plain style tape or "-DW" for Drop Warp style tape  
 Same price either version. Not all sizes available in drop warp style.
- All tapes are 100 foot / 30 metre lengths.
- Items with \* may have higher minimum order quantities – please call.
- \*\* .5"/13mm and .75"/19mm width tapes are not available in Drop Warp

**Fiberglass Woven Gasket & Thermal Insulating Tape:**  
**Premium Grade / Special Thin**  
**1200°F / 648°C: Very High Temperature & Heat Resistant Plain & Bolt-Hole /**  
**LadderTape™**



Manufactured of texturized fiberglass yarns, this tape will withstand temperatures up to 1200°F / 648°C in continuous service.

This tape offers superior insulating properties as well as low chloride content.

Offered in *Plain* and *Drop Warp (also known as Bolt-Hole or LadderTape™)*. Drop Warp tape has lengthwise yarns missing from the center of the tape to allow fasteners to pass through the tape for assembly onto access doors, etc.

Very High Temperature & Heat Resistant Fiberglass Woven Plain & Bolt-Hole / Drop-Warp / LadderTape™ Premium Grade / Special Thin 1/32" / .0313" / 0.8mm Thickness				
Part Number	Width in / mm		Price per Roll	
			no PSA	with PSA
T-FG-WOVEN-P-THIN-0.500-M013-X**	.5	13	\$ 16.88	\$ 27.43
T-FG-WOVEN-P-THIN-1.000-M025-X	1.0	25	\$ 24.20	\$ 37.23
T-FG-WOVEN-P-THIN-1.500-M038-X	1.5	38	\$ 31.40	\$ 54.13
T-FG-WOVEN-P-THIN-2.000-M051-X	2.0	51	\$ 37.73	\$ 65.33
T-FG-WOVEN-P-THIN-2.500-M064-X	2.5	64	\$ 45.10	\$ 85.90
T-FG-WOVEN-P-THIN-3.000-M076-X	3.0	76	\$ 52.53	\$ 106.37
T-FG-WOVEN-P-THIN-3.500-M089-X	3.5	89	\$ 60.47	\$ 120.86
T-FG-WOVEN-P-THIN-4.000-M102-X	4.0	102	\$ 67.80	\$ 135.40
T-FG-WOVEN-P-THIN-4.500-M114-X	4.5	114	\$ 75.63	\$ 149.30
T-FG-WOVEN-P-THIN-5.000-M127-X	5.0	127	\$ 82.73	\$ 163.13
T-FG-WOVEN-P-THIN-5.500-M140-X	5.5	140	\$ 89.96	\$ 176.47
T-FG-WOVEN-P-THIN-6.000-M152-X	6.0	152	\$ 96.90	\$ 189.80

- This tape is 1/32" / .0313" / 0.8mm thick
- For the "X" value in part number: use "-P" for Plain style tape or "-DW" for Drop Warp style tape. Same price either style.
- Add "-HT" to the part number for heat treated version. Add \$6.00 to roll price for heat treating.
- Add "-PSA" to the part number for tape with PSA coating.
- All tapes are 100 foot / 30 metre lengths.
- \*\* -08 / .5" / 13mm width tapes are not available in Drop Warp

**Fiberglass Colored Woven Tape:**  
**1200°F / 648°C: Very High Temperature & Heat Resistant: Industrial Grade**



Manufactured of texturized fiberglass yarns, tape will withstand temperatures up to 1200°F / 648°C in continuous service.

tape offers superior insulating properties as well as low chloride content.

Color coded tapes are an excellent solution for identifying hoses and pipes, for example, as supply (hotter) or return (cooler).

Available in Black, Blue, Red, Green, Silver

Only available in 1/16" thick.

1200°F / 648°C continuous rating, high insulation value & excellent personnel protection

Very High Temperature & Heat Resistant Fiberglass Woven Color Coded Tape			
Part Number	Width in / mm		Price per Roll By Length 15 feet / 25 feet / 50 feet
	T-FG-WOVEN-CC-1.000-M025-A-X-Y	1.0	
T-FG-WOVEN-CC-2.000-M051-A-X-Y	2.0	51	\$ 21.89 / \$ 33.64 / \$ 63.62

- For the "X" value, specify "BK" for black; "BL" for blue; "R" for red; "G" for green; "S" for silver/grey.
- For the "Y" value, add the length to the part number; -15, -25, -50

**MINIMUM ORDER 200 ROLLS**



## ProSil™ Silica/Glass Blend Woven Gasket & Thermal Insulating Tape

1350°F / 732°C: ProSil™ Very High Temperature & Heat Resistant  
Plain & Bolt-Hole / LadderTape™



ProSil™ Silica/Glass blended tape is a proprietary mixed yarn tape that remains soft and workable at temperatures where fiberglass tapes become brittle.

Withstands temperatures up to 1350°F / 732°C constant exposure without becoming brittle.

Offered in *Plain* and *Drop Warp (also known as Bolt-Hole or LadderTape™)*. Drop Warp tape has lengthwise yarns missing from the center of the tape to allow fasteners to pass through the tape for assembly onto access doors, etc. This is also called a Ladder or Bolthole tape.

Available with an acrylic Pressure Sensitive Adhesive (PSA) designed to aid in placement of the tape in gasket applications. The PSA will smoke off at temperatures above 425°F / 218°C.

**ProSil™ Silica/Glass Blend Woven Gasket & Thermal Insulating Tape**  
**1350°F / 732°C: Very High Temperature & Heat Resistant Plain & Bolt-Hole /**  
**LadderTape™**



1350°F / 732°C continuous rating, high insulation value & excellent personnel protection

Very High Temperature & Heat Resistant ProSil™ Silica/Glass Blended Tape Plain & Bolt-Hole / Drop-Warp / LadderTape™				
Part Number	Width in / mm		1/16" / 1/8" thickness Plain & Drop Warp No PSA	1/16" / 1/8" thickness Plain & Drop Warp with PSA
	T-PROSIL-0.5-M013-X-Z	.5	13	\$ 28.08 / \$ 51.84
T-PROSIL-1.0-M025-X-Z	1.0	25	\$ 36.84 / \$ 75.15	\$ 68.40 / \$ 116.04
T-PROSIL-1.5-M038-X-Z	1.5	38	\$ 52.29 / \$ 106.29	\$ 96.63 / \$ 166.92
T-PROSIL-2.0-M051-X-Z	2.0	51	\$ 67.80 / \$ 139.32	\$ 122.82 / \$ 215.76
T-PROSIL-2.5-M064-X-Z	2.5	64	\$ 83.34 / \$ 172.50	\$ 159.87 / \$ 276.18
T-PROSIL-3.0-M076-X-Z	3.0	76	\$ 98.64 / \$ 205.62	\$ 196.56 / \$ 336.60
T-PROSIL-3.5-M089-X-Z	3.5	89	\$ 114.12 / \$ 238.71	\$ 224.88 / \$ 387.69
T-PROSIL-4.0-M102-X-Z	4.0	102	\$ 129.57 / \$ 271.71	\$ 253.20 / \$ 438.72
T-PROSIL-4.5-M114-X-Z	4.5	114	\$ 152.22 / \$ 312.42	\$ 291.03 / \$ 499.98
T-PROSIL-5.0-M127-X-Z	5.0	127	\$ 174.84 / \$ 353.13	\$ 328.74 / \$ 561.18
T-PROSIL-5.5-M140-X-Z	5.5	102	\$ 190.50 / \$ 393.63	\$ 356.91 / \$ 621.39
T-PROSIL-6.0-M152-X-Z	6.0	152	\$ 206.13 / \$ 434.10	\$ 385.02 / \$ 681.69

- Roll length is 100 feet / 30 metres.
- For the "X" value, specify "A" or "B" in part number to correspond to the desired thickness.  
A = 1/16" / .0625" / 1.59mm B = 1/8" / .125" / 3.18mm
- For the "Z" value in part number: use "-P" for Plain style tape or "-DW" for Drop Warp style tape  
Same price either style.
- Add "-PSA" to the part number for tape with PSA coating.

## RockGlass™ Rock Fiber Basalt Woven Header Wrap & Thermal Insulating Tape

**1350°F / 732°C: Very High Temperature & Heat Resistant**



RockGlass™ is a tape manufactured from basalt rock fiber that remains soft and workable at temperatures where fiberglass tapes become brittle.

Withstands temperatures up to 1350°F / 732°C constant exposure without becoming brittle.

Available with an acrylic Pressure Sensitive Adhesive (PSA) designed to aid in placement of the tape in gasket applications. The PSA will smoke off at temperatures above 425°F / 218°C.

## RockGlass™ Rock Fiber Basalt Woven Header Wrap & Thermal Insulating Tape

1350°F / 732°C: Very High Temperature & Heat Resistant



1350°F / 732°C continuous rating, high insulation value & excellent personnel protection

Very High Temperature & Heat Resistant GlasRock™ Tape .045" Thick					
Part Number	Width in / mm		15 Foot Roll Length	25 Foot Roll Length	50 Foot Roll Length
			.045" thickness Plain / With PSA	.045" thickness Plain / With PSA	.045" thickness Plain / With PSA
T-RockGlas-1.0-M025-X-Y	1.0	25	\$ 9.96 / \$ 14.30	\$ 13.30 / \$ 23.30	\$ 23.17 / \$ 39.96
T-RockGlas-2.0-M051-X-Y	2.0	51	\$ 13.30 / \$ 19.96	\$ 19.96 / \$ 36.63	\$ 33.30 / \$ 66.63

- Roll lengths of 15, 25 and 50 feet
- For the "X" value, specify "15" for 15 foot roll, "25" for 25 foot roll, or "50" for 50 foot roll.
- For the "Z" value in part number: use "-P" for Plain style tape or "-PSA" for tape with PSA.



**Fiberglass Woven Gasket & Thermal Insulating Tape with Vermiculite Coating: Premium Grade**  
**1500°F / 815°C: FlameShield™ 1500 Very High Temperature & Heat Resistant**  
**Plain & Bolt-Hole / LadderTape™**



Plain tape shown on the left - Drop-Warp / Bolt Hole / Ladder tape shown on the right

Vermiculite coated fiberglass tape is manufactured from texturized fiberglass yarns then coated with Vermiculite, a 100% inorganic dispersion. Certified to meet the requirements of ASTM E 162, ASTM E 662 & SMP 800-C for surface flammability, smoke and toxic gas generation.

Vermiculite coated tape will withstand temperatures up to 1500°F / 815°C constant exposure with excursions to 2000°F / 1093°F. Also offers additional abrasion resistance and stiffness.

Offered in *Plain* and *Drop Warp (also known as Bolt-Hole or LadderTape™)*. Drop Warp tape has lengthwise yarns missing from the center of the tape to allow fasteners to pass through the tape for assembly onto access doors, etc. This is also called a Ladder-Tape or Bolt-hole tape.

Available with and without Pressure Sensitive Adhesive (PSA). Meets Federal Railroad Administration requirements for surface flammability and rate of smoke generation.



**Fiberglass Woven Gasket & Thermal Insulating Tape with Vermiculite Coating:  
Premium Grade (Continued)**



1500°F / 815°C continuous rating, high insulation value & excellent personnel protection

<b>Very High Temperature &amp; Heat Resistant Vermiculite Coated Fiberglass Tape Premium Grade Plain &amp; Bolt-Hole / Drop-Warp / LadderTape™</b>				
Part Number	Width in / mm		A / B / C thickness Plain & Drop Warp No PSA	A / B / C thickness Plain & Drop Warp with PSA
	T-FG-VC-WOVEN-P-M013-08-X-Z**	.5	13	\$ 79.50 / \$ 93.33 / NA
T-FG-VC-WOVEN-P-M019-12-X-Z**	.75	19	\$ 81.20 / \$ 96.67 / \$ 153.30	\$ 123.97 / \$ 141.50 / \$ 201.47
T-FG-VC-WOVEN-P-M025-16-X-Z	1.0	25	\$ 82.93 / \$ 99.83 / \$ 206.50	\$ 133.23 / \$ 150.80 / \$ 256.13
T-FG-VC-WOVEN-P-M032-20-X-Z	1.25	32	\$ 85.57 / \$ 111.27 / \$ 231.57	\$ 144.87 / \$ 170.57 / \$ 290.87
T-FG-VC-WOVEN-P-M038-24-X-Z	1.5	38	\$ 87.50 / \$ 114.58 / \$ 268.83	\$ 147.62 / \$ 178.65 / \$ 322.17
T-FG-VC-WOVEN-P-M051-32-X-Z	2.0	51	\$ 93.67 / \$ 128.90 / \$ 288.07	\$ 160.47 / \$ 195.37 / \$ 354.87
T-FG-VC-WOVEN-P-M064-40-X-Z	2.5	64	\$ 100.67 / \$ 144.31 / \$ 323.03	\$ 175.66 / \$ 219.32 / \$ 398.03
T-FG-VC-WOVEN-P-M076-48-X-Z	3.0	76	\$ 111.93 / \$ 167.03 / \$ 366.33	\$ 193.17 / \$ 446.67 / \$ 467.96
T-FG-VC-WOVEN-P-M089-56-X-Z	3.5	89	\$ 123.03 / \$ 182.11 / \$ 398.78	\$ 206.33 / \$ 265.40 / \$ 497.58
T-FG-VC-WOVEN-P-M102-64-X-Z	4.0	102	\$ 135.40 / \$ 198.20 / \$ 443.17	\$ 248.60 / \$ 292.56 / \$ 506.33
T-FG-VC-WOVEN-P-M127-80-X-Z	5.0	127	\$ 157.57 / \$ 262.73 / \$ 535.66	\$ 278.20 / \$ 374.67 / \$ 647.53
T-FG-VC-WOVEN-P-M152-96-X-Z	6.0	152	\$ 162.97 / \$ 286.43 / \$ 590.50	\$ 294.30 / \$ 384.40 / \$ 688.51

- For the "X" value, specify A, B or C in part number to correspond to the desired thickness  
A = 1/16" / .0625" / 1.59mm    B = 1/8" / .125" / 3.18mm    C = 1/4" / .250" / 6.35mm
- For "Z" value in part number: use "-P" for Plain style tape or "-DW" for Drop Warp style tape.  
Same price either style.
- Add "-PSA" to the part number for tape with PSA coating.
- 1/16" and 1/8" thick tapes are 100 foot lengths. For 1/4" thick tapes, larger widths may be available in 50 foot lengths.
- \*\* -08 / .5" / 13mm and -12 / .75" / 19mm width tapes are not available in Drop Warp

**Fiberglass Woven Gasket & Thermal Insulating Tape with Vermiculite  
Coating: Industrial Grade  
1500°F / 815°C: FlameShield™ 1500 Very High Temperature & Heat Resistant  
Plain & Bolt-Hole / LadderTape™**



Vermiculite coated fiberglass tape is manufactured from texturized fiberglass yarns then coated with Vermiculite, a 100% inorganic dispersion. Certified to meet the requirements of ASTM E 162, ASTM E 662 & SMP 800-C for surface flammability, smoke and toxic gas generation.

Vermiculite coated tape will withstand temperatures up to 1500°F / 815°C constant exposure with excursions to 2000°F / 1093°F. Also offers abrasion resistant stability.

Offered in *Plain* and *Drop Warp (also known as Bolt-Hole or LadderTape™)*. Drop Warp tape has lengthwise yarns missing from the center of the tape to allow fasteners to pass through the tape for assembly onto access doors, etc. This is also called a Ladder or Bolthole tape.

Available with and without Pressure Sensitive Adhesive (PSA). Meets Federal Railroad Administration requirements for surface flammability and rate of smoke generation.

## Fiberglass Woven Gasket & Thermal Insulating Tape with Vermiculite Coating: *Industrial Grade (Continued)*



1500°F / 815°C continuous rating, high insulation value & excellent personnel protection

Very High Temperature & Heat Resistant Vermiculite Coated Fiberglass Tape Industrial Grade Plain & Bolt-Hole / Drop-Warp / LadderTape™				
Part Number	Width in / mm		A / B thickness Plain & Drop Warp No PSA	A / B thickness Plain & Drop Warp with PSA
			T-FG-VC-WOVEN-I-M013-08-X-Z	.5
T-FG-VC-WOVEN-I-M019-12-X-Z	.75	19	\$ 62.53 / \$ 164.93	\$ 110.70 / \$ 244.61
T-FG-VC-WOVEN-I-M025-16-X-Z	1.0	25	\$ 66.84 / \$ 87.37	\$ 117.13 / \$ 139.00
T-FG-VC-WOVEN-I-M032-20-X-Z	1.25	32	\$ 73.60 / \$ 94.67	\$ 132.90 / \$ 150.63
T-FG-VC-WOVEN-I-M038-24-X-Z	1.5	38	\$ 75.06 / \$ 96.90	\$ 135.07 / \$ 156.90
T-FG-VC-WOVEN-I-M051-32-X-Z	2.0	51	\$ 81.40 / \$ 104.03	\$ 148.20 / \$ 170.83
T-FG-VC-WOVEN-I-M064-40-X-Z	2.5	64	\$ 101.43 / \$ 124.90	\$ 176.43 / \$ 198.79
T-FG-VC-WOVEN-I-M076-48-X-Z	3.0	76	\$ 108.50 / \$ 126.23	\$ 190.07 / \$ 207.81
T-FG-VC-WOVEN-I-M089-56-X-Z	3.5	89	\$ 114.96 / \$ 136.23	\$ 198.27 / \$ 219.53
T-FG-VC-WOVEN-I-M102-64-X-Z	4.0	102	\$ 122.71 / \$ 146.17	\$ 215.87 / \$ 239.33
T-FG-VC-WOVEN-I-M127-80-X-Z	5.0	127	\$ 145.13 / \$ 164.80	\$ 258.07 / \$ 294.47
T-FG-VC-WOVEN-I-M152-96-X-Z	6.0	152	\$ 150.27 / \$ 185.37	\$ 281.80 / \$ 316.70

- For the "X" value, specify "A" or "B" in part number to correspond to the desired thickness.  
A = 1/16" / .0625" / 1.59mm B = 1/8" / .125" / 3.18mm
- For "Z" value in part number: use "-P" for Plain style tape or "-DW" for Drop Warp style tape  
Same price either style.
- Drop Warp not available in 1/2 and 3/4 inch widths.
- \* **NOTE: 0.5" wide x 1/16" tape roll is 500 feet in length.**

**Fiberglass Woven Gasket & Thermal Insulating Tape with Vermiculite Coating: Premium Grade / Special Thin**  
**1500°F / 815°C: FlameShield™ 1500 Very High Temperature & Heat Resistant**  
**Plain & Bolt-Hole / LadderTape™**



Vermiculite coated fibreglass tape is manufactured from texturized fiberglass yarns then coated with Vermiculite, a 100% inorganic dispersion. Certified to meet the requirements of ASTM E 162, ASTM E 662 & SMP 800-C for surface flammability, smoke and toxic gas generation.

Vermiculite coated tape will withstand temperatures up to 1500°F / 815°C constant exposure with excursions to 2000°F / 1093°F. Also offers additional abrasion resistance and stiffness.

Offered in *Plain* and *Drop Warp (also known as Bolt-Hole or LadderTape™)*. Drop Warp tape has lengthwise yarns missing from the center of the tape to allow fasteners to pass through the tape for assembly onto access doors, etc. This is also called a Ladder Tape or Bolt-hole tape.

Available with and without Pressure Sensitive Adhesive (PSA). Meets Federal Railroad Administration requirements for surface flammability and rate of smoke generation.

1500°F / 815°C continuous rating, high insulation value & excellent personnel protection

<b>Very High Temperature &amp; Heat Resistant Fiberglass Woven Plain &amp; Bolt-Hole / Drop-Warp / LadderTape™ Premium Grade / Special Thin 1/32" / .0313" / 0.8mm Thickness</b>				
Part Number	Width in / mm		Price per Roll	
			no PSA	with PSA
T-FG-VC-WOVEN-P-T-M013-08-X	.5	13	\$ 26.43	\$ 36.53
T-FG-VC-WOVEN-P-T-M025-16-X	1.0	25	\$ 35.10	\$ 49.30
T-FG-VC-WOVEN-P-T-M038-24-X	1.5	38	\$ 48.73	\$ 70.83
T-FG-VC-WOVEN-P-T-M051-32-X	2.0	51	\$ 58.63	\$ 85.43
T-FG-VC-WOVEN-P-T-M064-40-X	2.5	64	\$ 70.13	\$ 109.66
T-FG-VC-WOVEN-P-T-M076-48-X	3.0	76	\$ 81.50	\$ 133.83
T-FG-VC-WOVEN-P-T-M089-56-X	3.5	89	\$ 93.90	\$ 152.57
T-FG-VC-WOVEN-P-T-M102-64-X	4.0	102	\$ 106.36	\$ 171.33
T-FG-VC-WOVEN-P-T-M114-72-X	4.5	114	\$ 117.40	\$ 188.96
T-FG-VC-WOVEN-P-T-M127-80-X	5.0	127	\$ 128.53	\$ 206.60
T-FG-VC-WOVEN-P-T-M140-88-X	5.5	140	\$ 139.56	\$ 226.33
T-FG-VC-WOVEN-P-T-M152-96-X	6.0	152	\$ 150.57	\$ 240.70

- This tape is 1/32" / .0313" / 0.8mm thick
- For the "X" value in part number: use "-P" for Plain style tape or "-DW" for Drop Warp style tape.
- Add "-PSA" to the part number for tape with PSA coating.
- All tapes are 100 foot lengths.

## Automotive Manifold, Header, Turbo & Exhaust Pipe Heat Insulating Tape & Wrap

1100°F / 593°C to 1500°F / 815°C: PowerTorque™ Tape

SilverGuard™ Fiberglass Woven Tape.

GoldGuard™ Fiberglass Woven Tape with Vermiculite Coating Tape.

BlackMax™ Fiberglass Woven Tape with Black Vermiculite Coating Tape.



Manifold and header wrapping is widely accepted as standard practice for performance auto and racing applications. There are two reasons for this. First, by adding an insulation layer around the exhaust gas pipig, it keeps the temperature of the gas from dropping, which means the density of the gas is kept lower longer, and lower density means easier flow through the exhaust system. Easier flow means more horse power due to reduced back pressure.

Retaining heat in the exhaust flow, resulting in faster exhaust gas flow, also results in higher turbo charger spool speeds, resulting in a gain of horse power.

Second, wrapping exhaust system components also reduces the temperature of other under-hood components and systems, reducing both radiated heat and convective heating of electrical components, intake air, fuel and hydraulic hoses. Reducing under-hood temperature also helps reduce hood paint thermal damage.

PowerTorque™ Very High Temperature & Heat Resistant Manifold, Header, Turbo & Exhaust Pipe Wrapping Tape SilverGuard™ ,GoldGuard™ and BlackMax™			
Part Number	Width in / mm		Price per Rol 25 ft / 50 ft / 100 ft
<b>PowerTorque™ SilverGuard™ Tape</b>			
T-FG-SG-M025-16-X	1.0	25	\$ 6.59 / \$ 12.55 / \$ 23.90
T-FG-SG-M051-32-X	2.0	50	\$ 9.67 / \$ 18.43 / \$ 34.43
<b>PowerTorque™ GoldGuard™ Tape</b>			
T-FG-GG-M025-16-X	1.0	25	\$ 19.67 / \$ 37.81 / \$ 66.84
T-FG-GG-M051-32-X	2.0	50	\$ 25.64 / \$ 46.71 / \$ 81.40
<b>PowerTorque™ BlackMax™ Tape</b>			
T-FG-BM-M025-16-X	1.0	25	\$ 8.99 / \$ 16.97 / \$ 31.93
T-FG-BM-M051-32-X	2.0	50	\$ 16.24 / \$ 31.37 / \$59.85

SilverGuard™ tape is Bright White, GoldGuard™ is a Tan/Gold color and BlackMax™ is Black

In the part number, replace the "X" value with the length of the tape: i.e.; 25, 50, 100

**Stainless Steel Free End Self Locking Clamps:** Used to secure tape in place. Makes a neat low profile installation. (standard hand tools can be used to tighten and cut the remaining free end)

- SSFCSL-WM005-XX. .181" width clamp. 6" \$1.21, 8" \$1.39, 14" \$1.59, 20" \$2.11
- SSFCSL-WM008-XX. .311" width clamp. 8" \$1.59, 14" \$2.29, 20" \$3.87



## Silica Slit Gasket & Thermal Insulating Tape

1800°F / 982°C: InSiMax™ Extreme High Temperature, Heat, Flame, Molten Metal & Weld Splatter Resistant



An alternative to asbestos and ceramic based textiles. Highly flexible and minimal shrinkage. High abrasion resistance and tensile strength. Melts above 3000°F / 1648°C. Available with a PSA (pressure sensitive adhesive) to facilitate easy installation (\*see note).

Produced from an extremely pure silica base fiber (SiO<sub>2</sub>) and can be used at 2000°F / 1093°C continuously with excursions to 3000°F / 1650°C.

Weave is tight, but edge fray is possible with slit tapes. For non fray edges use a woven tape.

1, 2 and 3 inch tapes shown

<b>InSiMax™ Extreme Temperature, Heat, Flame, Molten Metal &amp; Weld Splatter Resistant Silica Tapes</b>					
<b>0.090" / 2.3mm Thick Tape</b>					
<b>Part Number</b>	<b>Width inch / mm / dash #</b>			<b>Price per foot / Metre 25 &amp; 50 foot Standard Roll</b>	
T-S-SLIT-M025-16	1"	25	-16	\$ 1.32	\$ 4.33
T-S-SLIT-M032-20	1 1/4"	32	-20	\$ 1.52	\$ 4.98
T-S-SLIT-M038-24	1 1/2"	38	-24	\$ 1.68	\$ 5.51
T-S-SLIT-M051-32	2"	51	-32	\$ 2.04	\$ 6.69
T-S-SLIT-M064-40	2 1/2"	64	-40	\$ 3.08	\$ 10.10
T-S-SLIT-M076-48	3"	76	-48	\$ 3.72	\$ 12.20
T-S-SLIT-M102-64	4"	102	-64	\$ 4.98	\$ 16.33
T-S-SLIT-M127-80	5"	127	-80	\$ 5.80	\$ 19.02
T-S-SLIT-M152-96	6"	152	-96	\$ 6.63	\$ 21.75

**Available in standard 25 foot / 7.6 metre or 50 foot / 15.2 metre rolls  
For other lengths add +25% to price shown**

\* Note: The PSA will burn off at temperatures above 400°F and should be used to facilitate installation. Material with PSA should not be used in confined areas at elevated temperatures without ventilation until all of the PSA has vaporized.

To aid in mounting this tape onto surfaces, FlangeStik™ pressure sensitive adhesive spray can be used to place the tape in situ temporarily. Permanent fasteners or grab strips should be installed prior to heating of the area sprayed above 200°F. The adhesive will "smoke-off" at elevated temperatures.

**This Product is Available By-The-Foot / Metre**

## Fine Weave Silica Slit Gasket & Thermal Insulating Tape With PSA Adhesive

**1800°F / 982°C: InSilMax™ Extreme High Temperature, Heat, Flame, Fire,  
Molten Metal & Weld Splatter Resistant**



An alternative to asbestos and ceramic based textiles. Highly flexible and minimal shrinkage. High abrasion resistance and tensile strength. Melts above 3000°F / 1648°C. Includes an Acrylic PSA adhesive with backing release paper to facilitate easy installation (\*see note).

Produced from an extremely pure silica base fiber (SiO<sub>2</sub>) and can be used at 1800°F / 982°C continuously with excursions to 3000°F / 1650°C.

The base fabric is a fine weave, but edge fray is possible with slit tapes. As this tape has an adhesive coating the fray is minimized.

Top roll in photo is 1" wide .054" thick tape and bottom roll is 1" wide .030" thick tape. Bottom 2 rolls are 1 1/2" and 2" wide and are in their shipping protectors.

Used as a gasket tape on flanges for commercial ducting.

<b>InSilMax™ Extreme Temperature, Heat, Flame, Molten Metal &amp; Weld Splatter Resistant Fine Weave Silica Tape with Adhesive</b>					
<b>0.030" / .76 mm Thick Tape - 150 foot roll length</b>					
<b>Part Number</b>	<b>Width inch / mm / dash #</b>			<b>Price per Roll</b>	<b>Price per Foot</b>
T-S-SLIT-PSA-30-M025-16-X	1"	25	-16	\$ 131.25	\$ 3.06
T-S-SLIT-PSA-30-M038-24-X	1 1/2"	38	-24	\$ 195.00	\$ 4.55
T-S-SLIT-PSA-30-M051-32-X	2"	51	-32	\$ 247.50	\$ 5.78
<b>0.054" / 1.37 mm Thick Tape - 75 foot roll length</b>					
T-S-SLIT-PSA-54-M025-16-X	1"	25	-16	\$ 129.66	\$ 6.05
T-S-SLIT-PSA-54-M038-24-X	1 1/2"	38	-24	\$ 192.27	\$ 8.97
T-S-SLIT-PSA-54-M051-32-X	2"	51	-32	\$ 239.47	\$ 11.17

**For "X", Specify "F" for by-the-foot, or "R" for full roll**

\* Note: The PSA will burn off at temperatures above 400°F and should be used to facilitate installation. Material with PSA should not be used in confined areas at elevated temperatures without ventilation until all of the PSA has vaporized.

## Silica Folded & Stitched Gasket & Thermal Insulating Tape

1800°F / 982°C: InSilMax™ Extreme High Temperature, Heat, Flame, Molten Metal & Weld Splatter Resistant



An alternative to asbestos and ceramic based textiles. Highly flexible and minimal shrinkage. High abrasion resistance and tensile strength. Melts above 3000°F / 1648°C. Available with a PSA (pressure sensitive adhesive) to facilitate easy installation (\*see note).

Produced from an extremely pure silica base fiber (SiO<sub>2</sub>) and can be used at 1800°F / 982°C continuously with excursions to 3000°F / 1650°C.

Folded & Stitched tape is a thicker alternative to Slit Tape. Top roll in photo is one layer slit tape; 2<sup>nd</sup> roll from top is 2 layer folded and stitched; 3<sup>rd</sup> roll from top is three layer folded and stitched and bottom roll is 4 layer folded and stitched. All tapes are same length.

InSilMax™ Extreme Temperature, Heat, Flame, Molten Metal & Weld Splatter Resistant Folded & Stitched Silica Tape						
Folded & Stitched Silica Tape – 25 or 50 foot roll						
Available in 3 thicknesses: 1/8" / 3.2mm thick • 3/16" / 4.8mm thick • 1/4" / 6.4mm thick						
Width inch / mm / dash #			Part Number	1/8" / 3.2mm Price / Ft / m x value = 2	3/16" / 4.8mm Price / Ft / m x value = 3	1/4" / 6.4mm Price / Ft / m x value = 4
1"	25	-16	T-S-F-M025-16-X	\$3.44 / \$11.28	\$4.68 / \$15.35	\$5.98 / \$19.61
1 1/4"	32	-20	T-S-F-M032-20-X	\$4.12 / \$13.51	\$5.68 / \$18.63	\$7.24 / \$23.74
1 1/2"	38	-24	T-S-F-M038-24-X	\$4.76 / \$15.61	\$6.56 / \$21.52	\$8.52 / \$27.95
2"	51	-32	T-S-F-M051-32-X	\$6.36 / \$20.86	\$8.96 / \$29.39	\$15.64 / \$51.30
2 1/2"	64	-40	T-S-F-M064-40-X	\$7.32 / \$24.01	\$9.04 / \$29.65	\$14.72 / \$48.28
3"	76	-48	T-S-F-M076-48-X	\$8.56 / \$28.08	\$12.36 / \$40.54	\$16.12 / \$52.87
4"	102	-64	T-S-F-M102-64-X	\$11.04 / \$36.21	\$16.12 / \$52.87	\$23.60 / \$77.41
5"	127	-80	T-S-F-M127-80-X	\$13.64 / \$44.74	\$19.97 / \$65.50	\$26.32 / \$86.33
6"	152	-96	T-S-F-M152-96-X	\$16.12 / \$52.87	\$23.76 / \$77.93	\$31.32 / \$102.73
8"	203	-102	T-S-F-M203-102-X	\$21.88 / \$71.77	\$33.20 / \$108.90	\$43.80 / \$143.66

For other than standard lengths, add 20% to the price shown

For the "X" value in the part number: specify "2" for 1/8" thick tape  
"3" for 3/16" thick tape  
"4" for 1/4" thick tape

Add "-P" to the part number to order tape with PSA on one side.

\* Note: The PSA will burn off at temperatures above 400°F and should be used to facilitate installation. Material with PSA should not be used in confined areas at elevated temperatures without ventilation until all of the PSA has vaporized.

To aid in mounting this tape onto surfaces, FlangeStik™ pressure sensitive adhesive spray can be used to place the tape in situ temporarily. Permanent fasteners or grab strips should be installed prior to heating of the area sprayed above 200°F. The adhesive will "smoke-off" at elevated temperatures.

## Silica Woven Gasket & Thermal Insulating Tape

1900°F / 1037°C: InSilMax™ Extreme High Temperature, Heat, Flame, Molten Metal & Weld Splatter Resistant



Available in Plain and Drop Warp (also known as Ladder Tape™ or Bolt-Hole Tape).

An alternative to asbestos and ceramic based textiles. Highly flexible and minimal shrinkage. High abrasion resistance and tensile strength. Melts above 3000°F / 1648°C. Available with a PSA (pressure sensitive adhesive) to facilitate easy installation (\*see note).

Woven tape has the benefit over slit tape of edges that will not fray unless cut.

Common applications for this tape are as a gasket and seal material on high temperature access doors, inspection and clean-out doors and panels for kilns, ovens, furnaces, ventilation systems, etc.

InSilMax™ Extreme Temperature, Heat, Flame, Molten Metal & Weld Splatter Resistant Woven Silica Tapes						
Plain & Drop Warp Woven Silica Tape – 100 foot roll						
Available in 3 thicknesses: 1/16" / 2mm thick • 1/8" / 3.2mm thick • 1/4" / 6.4mm thick						
Width inch / mm / dash #			Part Number	1/16" / 2mm Price per foot no PSA / with PSA	1/8" / 3.2mm Price per foot no PSA / with PSA	1/4" / 6.4mm Price per foot no PSA / with PSA
1"	25	-16	T-S-WOVEN-M025-16-X-Z	\$ 1.77 / \$ 2.15	\$ 4.02 / \$ 4.55	\$ 5.04 / \$ 5.56
1 1/2"	38	-24	T-S-WOVEN-M038-24-X-Z	\$ 2.47 / \$ 3.03	\$ 5.64 / \$ 6.42	\$ 7.36 / \$ 8.14
2"	51	-32	T-S-WOVEN-M051-32-X-Z	\$ 3.21 / \$ 3.91	\$ 7.41 / \$ 8.44	\$ 9.68 / \$ 10.66
3"	76	-48	T-S-WOVEN-M076-48-X-Z	\$ 4.72 / \$ 5.98	\$ 11.09 / \$ 12.77	\$ 14.63 / \$ 16.32
4"	102	-64	T-S-WOVEN-M102-64-X-Z	\$ 6.05 / \$ 7.62	\$ 14.92 / \$ 17.07	\$ 19.52 / \$ 21.68

Same Price Plain or Drop Warp (known as LadderTape™ or Bolt-Hole Tape)

**This Product is Available in Full Rolls Only – Please enquire for exceptions**

Some tapes available in 50 foot lengths – please enquire. Add 25% to above pricing when ordering in 50 foot lengths. Some tapes available in by-the-foot cut lengths – please enquire. Add 50% to above pricing when ordering by-the-foot cut lengths.

- For the "X" value, specify: "A" for 1/16" thick tape, "B" for 1/8" thick tape "C" for 1/4" thick tape
- For "Z" value in part number: use "-P" for Plain style tape or "-DW" for Drop Warp style tape.

Add "-PSA" to the part number to order tape with PSA on one side.

\* Note: The PSA will burn off at temperatures above 400°F and should be used to facilitate installation. Material with PSA should not be used in confined areas at elevated temperatures without ventilation until all of the PSA has vaporized.



## Ceramic Fiber Gasket & Thermal Insulating Woven Tape

2000°F / 1093°C: CerMax™ Extreme High Temperature, Heat, Flame, Molten Metal & Weld Splatter Resistant



Available in Plain and Drop Warp style (also known as Ladder Tape™ or Bolt-Hole Tape).

Highly flexible and virtually no shrinkage. Melts above 3000°F / 1648°C.

Woven tape has the benefit of edges that will not fray unless cut.

Ceramic fiber tapes do not have the mechanical tensile strength of tapes made from other materials due to the short fiber lengths. To enhance the mechanical durability and handleability, these tapes are made with either Fiberglass or Inconel wire reinforcement.

Common applications for this tape are as a gasket and seal material on high temperature access doors, inspection and clean-out doors and panels for kilns, ovens, furnaces, ventilation systems, etc.

CerMax™ Extreme Temperature +Plus, Heat, Flame, Molten Metal & Weld Splatter Resistant Ceramic Fiber Tapes - 100 foot roll length					
Width inch / mm		Part Number	1/16" / 2mm thick Price per roll Fiberglass / Wire insert	1/8" / 3.2mm thick Price per roll Fiberglass / Wire insert	1/4" / 6.4mm thick Price per roll Fiberglass insert
1/2	13	T-C-WOVEN-0.500-M013-X-Y	\$ 28.75 / NA	\$ 35.65 / NA	NA
1"	25	T-C-WOVEN-1.000-M025-X-Y	\$ 43.70 / \$ 51.75	\$ 59.80 / \$ 66.70	NA
1 1/2"	38	T-C-WOVEN-1.500-M038-X-Y	NA / NA	\$ 88.55 / NA	NA
2"	51	T-C-WOVEN-2.000-M051-X-Y	\$ 78.20 / \$ 93.15	\$ 106.95 ** / \$ 124.20	\$ 210.00
2 1/2"	64	T-C-WOVEN-2.500-M064-X-Y	NA	NA / \$ 154.00	NA
3"	76	T-C-WOVEN-3.000-M076-X-Y	\$ 112.70 / \$ 117.30	\$ 154.10 ** / \$ 170.20	NA
4"	102	T-C-WOVEN-4.000-M102-X-Y	\$ 141.45 / \$ 149.50	\$ 193.20 ** / \$ 218.50	NA
6"	152	T-C-WOVEN-6.000-M152-X-Y	NA / NA	NA / \$ 331.20	NA

\*\* Note: 1/8 thick; 2", 3" and 4" wide, fiberglass reinforced, is available in Plain or Drop Warp (also known as LadderTape™ or Bolt-Hole Tape). Same price either version.

Some tapes available in 50 foot lengths – please enquire. Add 25% to above pricing when ordering in 50 foot lengths. Some tapes available in by-the-foot cut lengths – please enquire.

- For the "X" value, specify: "A1" for 1/16" thick tape or "B2" for 1/8" thick tape
- For the "Y" value, specify: "F" for Fiberglass reinforced or "W" for wire reinforced
- Add "-DW" to specify Drop Warp style tape (Only in 2", 3" and 4" widths in 1/8" thick).



To aid in mounting this tape onto surfaces, FlangeStik™ pressure sensitive adhesive spray can be used to place the tape in situ temporarily. Permanent fasteners or grab strips should be installed prior to heating of the area sprayed above 200°F. The adhesive will “smoke-off” at elevated temperatures.

**Note regarding the Inconel wire re-enforced tapes:** Inconel alloys are oxidation- and corrosion-resistant materials well suited for service in extreme environments subjected to high pressure and kinetic energy. When heated, Inconel forms a thick and stable passivating oxide layer protecting the surface from further attack. Inconel retains strength over a wide temperature range, attractive for high-temperature applications where aluminum and steel would succumb to creep. **Caution:** Tapes with Inconel wire insert are electrically conductive.

### **CerMax Tape Technical Data**

CerMax is alumino-silicate based refractory fiber. White and odorless. Available with either a fiberglass or wire re-inforcement. Some organic binder is present, and will smoke-off at elevated temperatures. Once the organics have smoked-off, the product will turn white again. If smoke free operation is required, then it should be heat treated before use.

**Chemical & Physical Data:** Total  $Al_2O_3$  and  $SiO_2$  > 97% ( $Al_2O_3$ : 47%);  $Fe_2O_3$  <1.1%. Weight Loss (1800°F) 8-10%; Refractory Fiber content >85%. Fiber diameter: 2 - 4 microns; Fiber length: 100 - 250 mm. Fiber shrinkage (1800°F, 3 hr) <3.5%

**Thermal Conductivity:** 570°F: 0.84 BTU/ft<sup>2</sup> °F/in (0.12 W/m °K). 1100°F: 0.91 BTU/ft<sup>2</sup> °F/in (0.13 W/m °K). 1800°F: 1.19 BTU/ft<sup>2</sup> °F/in (0.17 W/m °K).

**Flexible Graphite Tape (Corrugated / Crinkled)**  
**950°F / 510°C to 5400°F / 2982°C GraphTek™ Extreme High Temperature, Heat, Flame, Molten Metal & Weld Splatter Resistant**

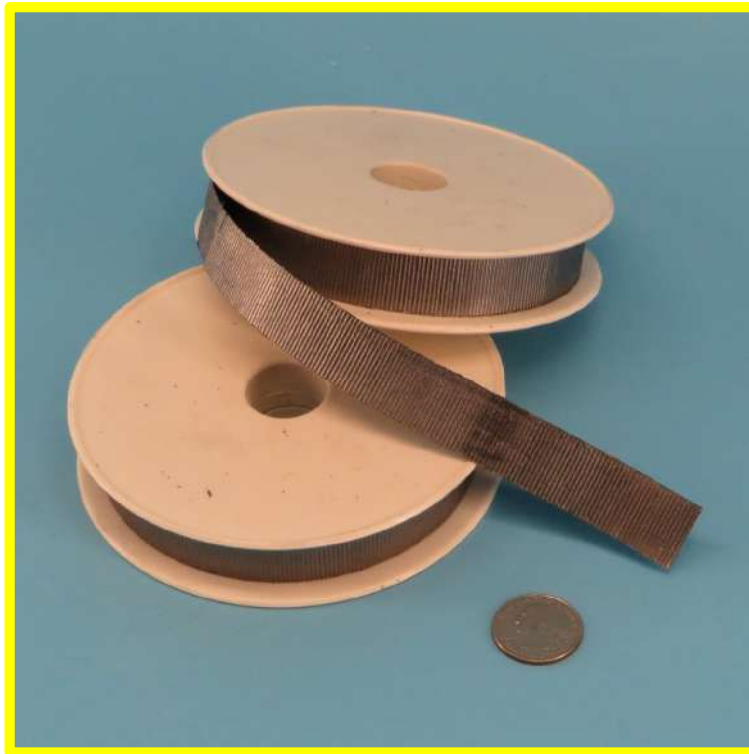

Flexible Graphite Tape is 99% Carbon, providing extreme heat protection, thermal dissipation, lubrication but does not add electrical conductivity. Made from mineral (flake) graphite it is non metallic, but thermally and electrically conductive just like metals.

Highly flexible and virtually no shrinkage. Melts above 6600°F / 3650°C.

This tape is corrugated / crinkled to aid in handling.

Service temperature range depends on surrounding conditions. Useable to 950°F / 510°C in an oxidizing atmosphere (standard air). Useable to 1500°F / 815°C in mild oxidizing or steam atmosphere and useable to 5400°F / 2982°C in non-oxidizing conditions.

Common applications for this tape are as an extreme temperature wrap for protection against flame and molten metal contact. Also used as gasket and seal material.

<b>GraphTek™ Extreme Temperature +Plus, Heat, Flame, Molten Metal &amp; Weld Splatter Resistant Graphite Tapes</b>						
<b>50 foot roll - .050" thick</b>						
<b>Width inch / mm / dash #</b>			<b>Part Number</b>	<b>Plain Tape</b>	<b>Plain Tape with PSA</b>	<b>Plain Tape with inhibitor</b>
1/4	6	-04	T-GR-M006-04-X	\$ 5.86	\$ 9.74	NA
1/2"	13	-08	T-GR-M013-08-X	\$ 7.85	\$ 13.53	\$ 8.63
3/4"	19	-12	T-GR-M019-12-X	\$ 10.73	\$ 18.94	\$ 11.80
1"	25	-16	T-GR-M025-16-X	\$ 13.61	\$ 23.80	\$ 14.97
1 1/2"	39	-24	T-GR-M039-24-X	NA	\$ 29.84	NA

- For the "X" value, specify:  
"P" for plain tape.  
"PSA" for tape with PSA  
"IN" for tape with inhibitor

**Heat Reflective Aluminum Foil Coated Fiberglass Tape:  
Plain or with Pressure Sensitive Adhesive (PSA)  
1000°F / 537°C: Peak with 650°F / 343°C**



- Protection from intense radiant heat.
- Reflects more than 95% of the radiant heat that contacts its surface.
- Continuous operation at 650°F / 343°C.
- This tape is the perfect protection for cables and hoses when radiant heat from infrared sources such as super-hot metal slabs, proximity to liquid metal, open flame/plasma or engine exhaust manifolds is a concern.
- Can be supplied with self-adhesive (includes a backing paper).

**Heat Reflective Aluminum Foil Coated Fiberglass Tape (Continued):  
Plain or with Pressure Sensitive Adhesive (PSA)  
1000°F / 537°C: Peak with 650°F / 343°C**



Constructed from a high-temperature base fabric which is then coated with highly-reflective polished aluminum. Designed for long term continuous operation at 650°F / 343°C, this tape will withstand short duration exposure up to 1200°F / 650°C. The aluminum coating melts at 1220°F / 660°C, however it does take some time for the aluminum to absorb enough heat to melt – thereby it can withstand short exposure to the higher temperatures.

The tape is fabricated by slitting from a roll fabric; the table below shows the most popular sizes - other sizes available. The same base fabric can be used for constructing a wide variety of protective sleeves and covers.

<b>Aluminized (Aluminum Foil Coated) Fiberglass Radiant Heat Reflective Tape</b> Available plain and with PSA adhesive		
Part Number	Width inch / mm	Price per Foot 21oz/yd <sup>2</sup> / 35oz/yd <sup>2</sup>
T-FG-AL-ST-M019-12-X	0.75 / 19	\$ 2.87 / \$ 3.44
T-FG-AL-ST-M025-16-X	1.00 / 25	\$ 3.55 / \$ 4.26
T-FG-AL-ST-M032-20-X	1.25 / 32	\$ 4.19 / \$ 5.03
T-FG-AL-ST-M038-24-X	1.50 / 38	\$ 4.87 / \$ 5.84
T-FG-AL-ST-M044-28-X	1.75 / 44	\$ 5.55 / \$ 6.67
T-FG-AL-ST-M051-32-X	2.00 / 51	\$ 6.21 / \$ 7.45
T-FG-AL-ST-M064-40-X	2.50 / 64	\$ 7.59 / \$ 9.11
T-FG-AL-ST-M076-48-X	3.00 / 76	\$ 8.91 / \$ 10.70
T-FG-AL-ST-M089-56-X	3.50 / 89	\$ 10.27 / \$ 12.33
T-FG-AL-ST-M102-64-X	4.00 / 102	\$ 11.58 / \$ 13.90
This tape can be fabricated in any width – please enquire		

For the X value: specify "21" for construction from 21 oz/yd<sup>2</sup> fabric; specify "35" for construction from 35 oz/yd<sup>2</sup> fabric

Standard roll lengths are 50 and 100 feet - other custom lengths available

## Stainless Steel Foil Coated Fiberglass Tape

1000°F / 537°C: High Temperature & Radiant Heat Reflective – Non Adhesive or with Pressure Sensitive Adhesive (PSA)

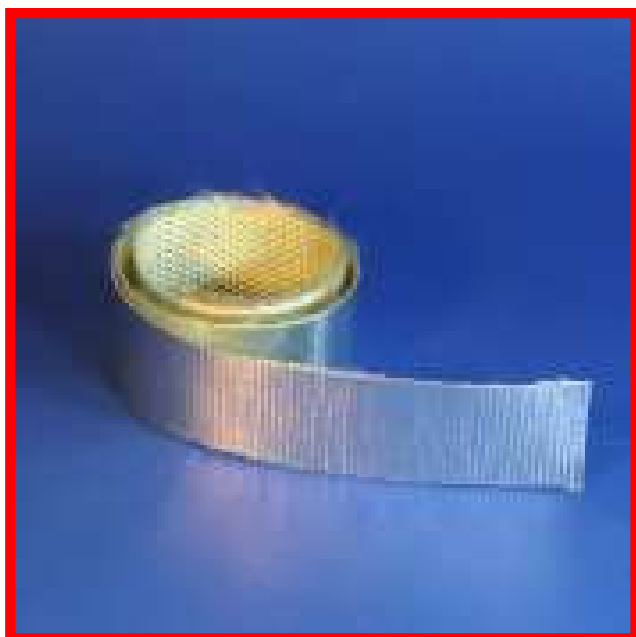

- Protection from intense radiant heat.
- Reflects more than 95% of the radiant heat that contacts its surface.
- Continuous operation at 650°F / 343°C.
- This tape is the perfect protection for cables and hoses when radiant heat from infrared sources such as super-hot metal slabs, proximity to liquid metal, open flame/plasma or engine exhaust manifolds is a concern.
- Can be supplied with self-adhesive (includes a backing paper).

Constructed from a high-temperature base fabric which is then coated with a layer of stainless steel foil. Designed for long term continuous operation at 650°F / 343°C, this tape will withstand short duration exposure up to 1200°F / 650°C. The aluminum coating melts at 1220°F / 660°C, however it does take some time for the aluminum to absorb enough heat to melt – thereby it can withstand short exposure to the higher temperatures.

The tape is slit from a roll fabric.

The same base fabric can be used for constructing a wide variety of protective sleeves and covers for wire & cable covers, Festoon covers, robotic welding machine covers, etc.

Stainless Steel Coated Fiberglass Radiant Heat Reflective Tape		
Part Number	Width inch / mm	Price / Foot
T-FG-SS-SLIT	Any Width to 36" maximum	Call

- For the “X” value, specify: “P” for plain tape with no PSA, “PSA” for tape with PSA (call for pricing)



**EMI / RFI / EMF Protection Tape - Nickel-Copper coating on Polyester Backing - self adhesive**  
**302°F / 150°C: High Temperature & Radiant Heat Reflective**



- Excellent EMI / RFI / EMF shielding tape for wrapping wires and cables.
- Easy to install - has a conductive acrylic adhesive for superior shielding.
- Roll lengths of 25 feet.
- RoHS compliant.
- 0.004" thick + adhesive thickness.

Polyester - NiCu EMI / RFI / EMF Protection Wrapping Tape - with self adhesive		
Part Number	Width inch / mm	Price per roll
T-EMIRFI-POLY-NICU-ACL-M025-16	1.00 / 25	\$ 183.16
T-EMIRFI-POLY-NICU-ACL-M051-32	2.00 / 51	\$ 247.63

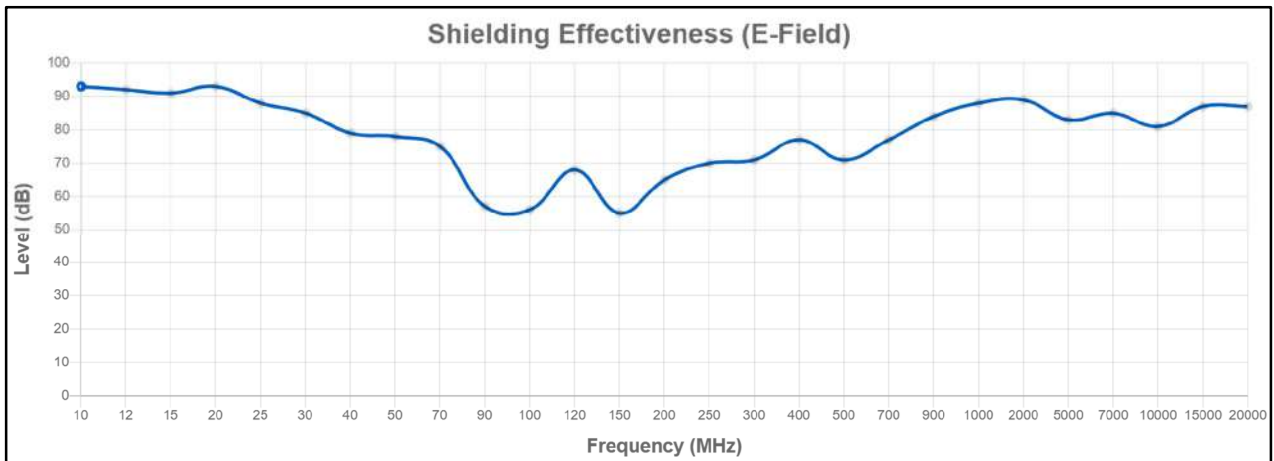

**EMI / RFI / EMF Protection Tape - Tinned Copper Knit Mesh with  
Aluminized Polyester Backing - self adhesive**  
302°F / 150°C: High Temperature & Radiant Heat Reflective



- Excellent EMI / RFI / EMF shielding tape for wrapping wires and cables.
- Tinned copper knit mesh with aluminized polyester support backing.
- Easy to install - has an acrylic adhesive with release liner.
- Roll lengths of 25 feet.
- RoHS compliant.
- 0.004" thick + adhesive thickness.
- Designed for low flex applications as tinned copper knit mesh may over time abrade the support backing in high flex installation

Tinned Copper Mesh EMI / RFI / EMF Protection Wrapping Tape - with self adhesive		
Part Number	Width inch / mm	Price per roll
T-EMIRFI-SnCu-ALACL-M025-16	1.00 / 25	\$ 183.16
T-EMIRFI-SnCu-ALACL-M051-32	2.00 / 51	\$ 247.63

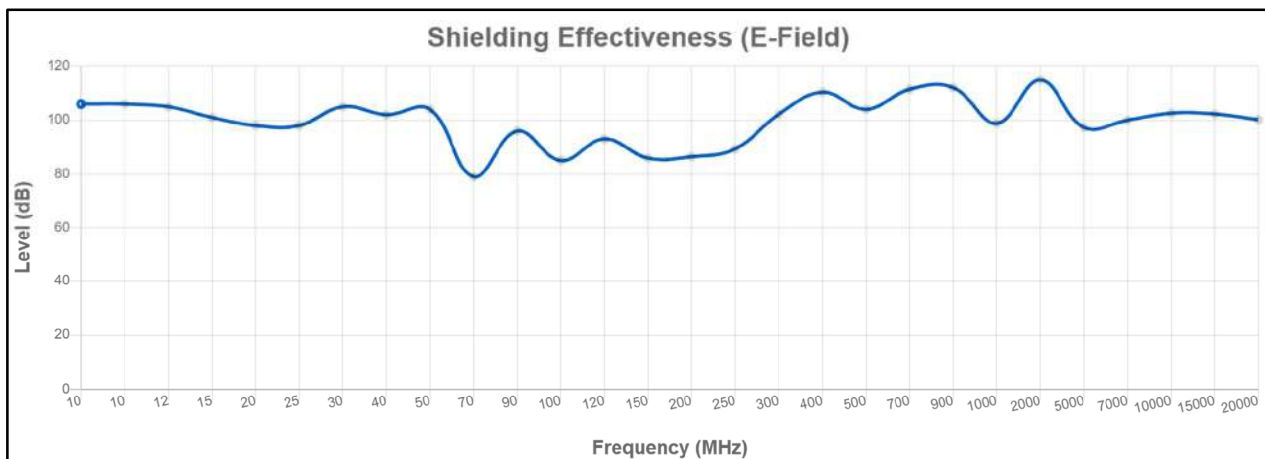

**EMI / RFI / EMF Tinned Copper Knit Mesh with Copper Foil Backing  
 Protection Tape - self adhesive  
 302°F / 150°C: High Temperature & Radiant Heat Reflective**



- Excellent EMI / RFI / EMF shielding tape for wrapping wires and cables.
- Tinned copper knit mesh with aluminized polyester support backing.
- Easy to install - has an acrylic adhesive with release liner.
- Roll lengths of 25 feet.
- RoHS compliant.
- 0.004" thick + adhesive thickness.
- Designed for low flex applications as tinned copper knit mesh may over time abrade the support backing in high flex installation

Tinned Copper Mesh EMI / RFI / EMF Protection Wrapping Tape - with self adhesive		
Part Number	Width inch / mm	Price per roll
T-EMIRFI-SnCu-CUACL-M025-16	1.00 / 25	\$ 183.16
T-EMIRFI-SnCu-CUACL-M051-32	2.00 / 51	\$ 247.63

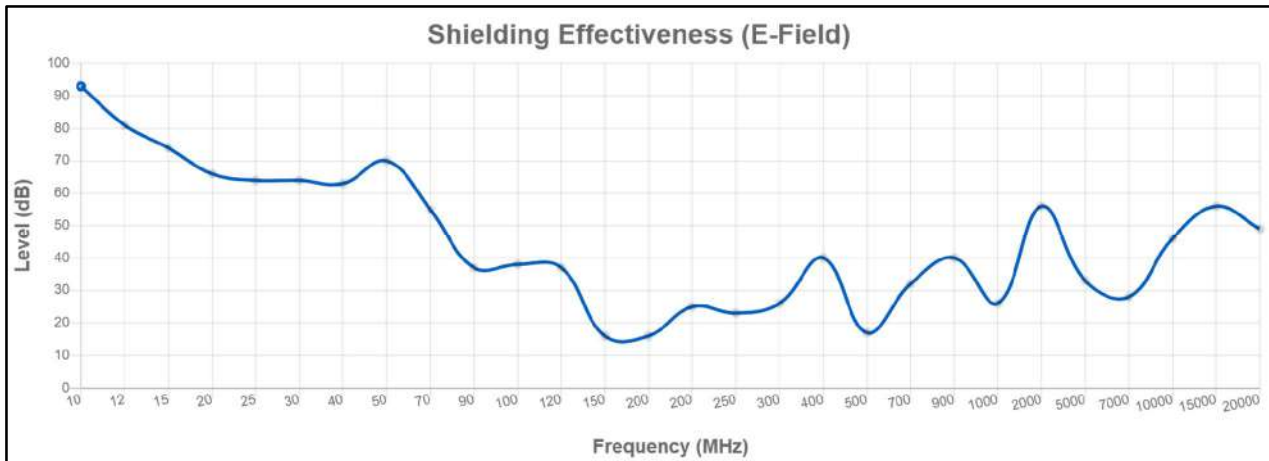



**Thermal, EMI/RFI & Abrasion Protection Materials**

Fax Orders: 610-340-9054 Telephone Orders: 610-906-3549 [orders@abthermal.com](mailto:orders@abthermal.com)

---

**Aluminum Foil Tape with Acrylic Adhesive**  
**1000°F / 537°C: High Temperature & Radiant Heat Reflective: Meets MIL-T-23397B**  
**Type II**

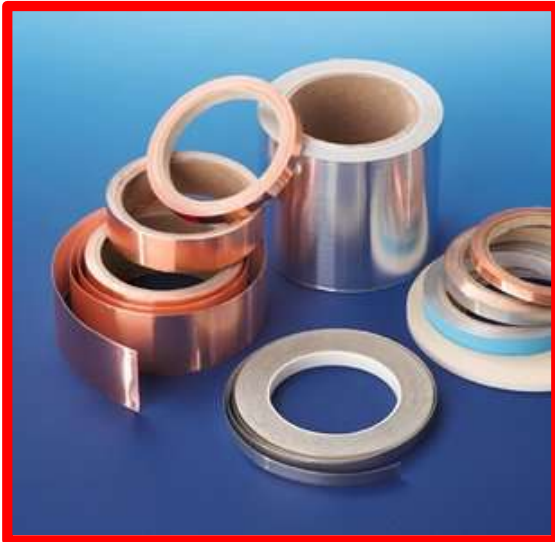

- Aluminum tape is an excellent reflector of radiant heat. Reflects more than 95% of the radiant heat that contacts its surface.
- Makes an excellent EMI/RFI shielding tape.
- Adheres and conforms to irregular surfaces.
- Provides a waterproofing/vapour and air barrier. Non-permeable.
- Heavy Duty .003" thickness foil with .002" thickness of adhesive.
- Roll length is 60 yards / 180 feet.
- Used as a masking tape for plating and painting applications.
- Aluminum foil melts at 1162°F / 627°C.
- Meets MIL-T-23397B, Type II

<b>FlameShield™ High Temperature Aluminum Foil Tape with Acrylic Adhesive. MIL-T-23397B Type II</b>			
<b>Part Number</b>	<b>Tape Width inch / mm</b>		<b>Price per Roll</b>
T-AL-PSA-M013-08	0.50	13	\$ 26.58
T-AL-PSA-M019-12	0.75	19	\$ 39.85
T-AL-PSA-M025-16	1.00	25	\$ 53.12
T-AL-PSA-M051-32	2.00	51	\$ 106.25

**The acrylic adhesive will smoke off at temperatures above 325°F/162°C**

**This tape is available in any width – please call for other sizes**



**Lead Foil Tape with Natural Rubber Adhesive**  
**572°F / 300°C: High Temperature & Heat Resistant**

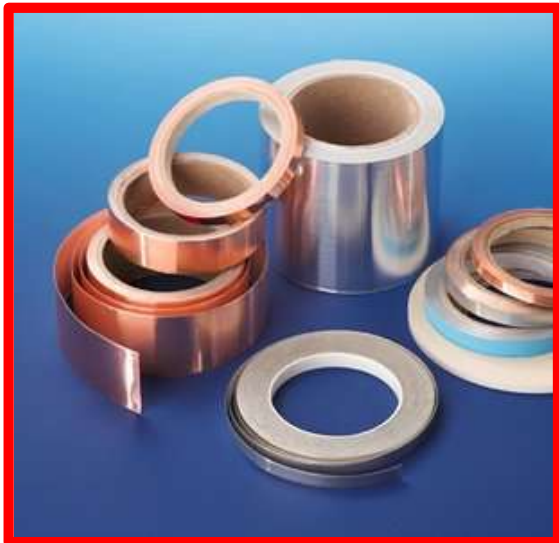

- Makes an excellent EMI/RFI shielding tape.
- Adheres and conforms to irregular surfaces.
- Provides a waterproofing/vapour and air barrier. Non-permeable.
- Heavy Duty .004" thickness foil with .0023" thickness of adhesive.
- Roll length is 36 yards / 108 feet.

<b>FlameShield™ High Temperature Lead Foil Tape with Natural Rubber Adhesive</b>			
<b>Part Number</b>	<b>Tape Width inch / mm</b>		<b>Price per Roll</b>
T-LD-NRAD-M013-08	0.50	13	\$ 118.03
T-LD-NRAD-M019-12	0.75	19	\$ 149.53
T-LD-NRAD-M025-16	1.00	25	\$ 186.90
T-LD-NRAD-M051-32	2.00	51	\$ 373.80

**The rubber adhesive will smoke off at temperatures above 225°F/107°C**

**This tape is available in any width – please call for other sizes**

**GoldLook™ - Colored Aluminized PET Film With Acrylic Adhesive**  
**572°F / 300°C: High Temperature & Heat Resistant**



- Fiberglass Scrim base support fabric provides dimensional stability.
- Designed as a dress-up tape for automotive applications.
- Adheres and conforms to irregular surfaces.
- Provides a waterproofing/vapour and air barrier. Non-permeable.
- .006” total thickness.
- Roll length is 50 yards / 150 feet

<b>FlameShield™ Gold Look PET Film Tape with Acrylic Adhesive</b>			
<b>Part Number</b>	<b>Tape Width inch / mm</b>		<b>Price per Roll</b>
T-FG-CAL-M013-08	0.50	13	\$ 118.03
T-FG-CAL-M019-12	0.75	19	\$ 149.53
T-FG-CAL-M025-16	1.00	25	\$ 186.90
T-FG-CAL-M051-32	2.00	51	\$ 373.80

**This tape is available in any width – please call for other sizes**

## Aluminized PET Film Coated Fiberglass Tape; with adhesive 1000°F / 537°C: FlameShield™ High Temperature & Radiant Heat Reflective



- Protection from intense radiant heat. Reflects more than 95% of the radiant heat that contacts its surface.
- Base fabric rated for continuous operation at 1000°F / 537°C.
- This tape has a high temperature adhesive across its entire width, allowing the tape to be wrapped and formed into a sleeve around wires, cables or hoses. Can also be applied to other objects and shapes and used flat.
- Provides protection for cables and hoses when radiant heat from infrared sources such as super-hot metal slabs, proximity to liquid metal, open flame/plasma or engine exhaust manifolds is a concern.
- Thickness of .025".

This high temperature and radiant heat reflective tape is constructed from a high-temperature fine woven fiberglass fabric substrate, which is then coated with highly-reflective aluminized PET film. The base fabric is designed for long term continuous operation at 1000°F / 537°C, this sleeve will withstand short duration exposure up to 1200°F / 650°C. The non aluminized side of the fabric is coated with an acrylic adhesive and release paper.

Added protection can be achieved by layering with other sleeve or tape materials underneath the reflective layer.

FlameShield™ Aluminized PET Coated Fiberglass Radiant Heat Reflective Tape with Pressure Sensitive Adhesive			
Part Number	Width inch / mm / dash	Spool Length, feet Bulk / Small	Price per Foot Bulk Spool / Small Spool
T-FG-ALM-PSA-M025-16-X	1.00 / 25 / -16	200 / 100	\$ 2.00 / \$ 2.17
T-FG-ALM-PSA-M038-24-X	1.50 / 38 / -24	200 / 100	\$ 3.10 / \$ 3.26
T-FG-ALM-PSA-M051-32-X	2.00 / 51 / -32	200 / 100	\$ 3.82 / \$ 3.97
T-FG-ALM-PSA-M076-48-X	3.00 / 76 / -48	200 / 100	\$ 5.72 / \$ 5.98
T-FG-ALM-PSA-M102-64-X	4.00 / 102 / -64	200 / 100	\$ 7.57 / \$ 7.74
T-FG-ALM-PSA-M127-80-X	5.00 / 127 / -80	200 / 100	\$ 9.42 / \$ 9.57
T-FG-ALM-PSA-M152-96-X	6.00 / 152 / -96	100 / 50	\$ 11.33 / \$ 11.67
T-FG-ALM-PSA-M178-112-X	6.875 / 175 / -103	100 / 50	\$ 13.20 / \$ 13.53

For the "X" value: use "B" for Bulk Spool size, use "S" for Small Spool size

This Product is Available in Spool Length Only

## Weld Backing Tape

1000°F / 537°C: FlameShield™ Easily provides gas tight weld backing purge area and bead consistency

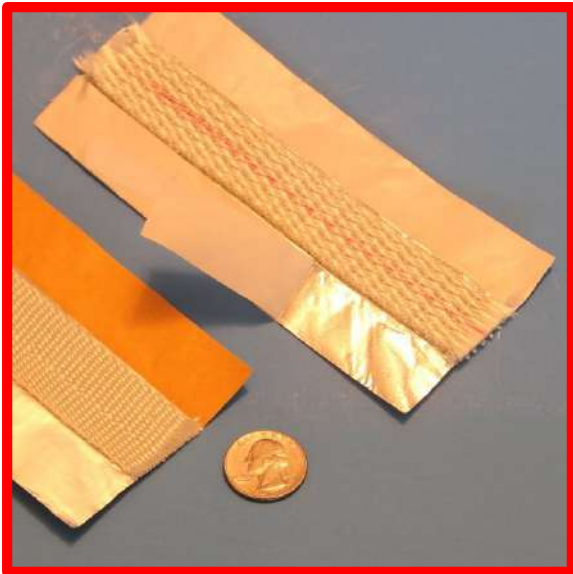
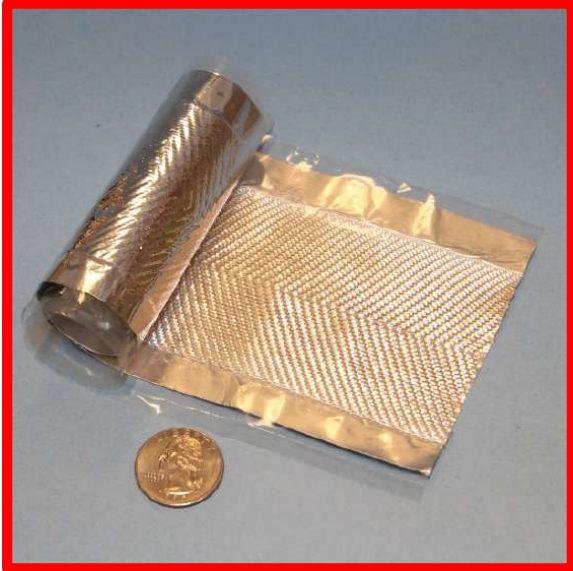

- Typically for welding thin wall stainless steel from one side. Attaches to the backside of the weld area and supports the weld pool, keeps the argon gas surrounding the weld pool.
- Eliminates the need to back-purge.
- Provides a consistent high quality under bead profile.
- The most popular tape is 3" wide with a 1" wide woven DeltaGlass tape strip in the middle.
- Supports single pass welding at currents up to 240 amps without change to the chemistry or metallurgy of the weld.
- Available in Light Duty (80 amp), Medium Duty (160 amp) and Heavy Duty (240 amp) ratings.

FlameShield™ Weld Backing Tape					
Part Number	Recommended Amp Max	Center Insulation Thickness	Tape Width	Tape Length, feet	Price
T-FG-AL-WELD-80	80	1/32	3.0"	40	\$ 182.75
T-FG-AL-WELD-160	160	1/16	3.0"	40	\$ 197.57
T-FG-AL-WELD-240	240	1/8	3.0"	40	\$ 217.48

## Insulated Wrap Tape - InsulSave™

For Pipe / Hose / Cable Protection. High Thermal Insulation Value

Provides burn protection for personnel working near hot pipes & hoses

**500°F / 260°C:** suitable for steam and process piping/hoses – hot or cold protection and energy savings. Useable from -67°F (-55°C) to +500°F (260°C) at the inner contact point.



Photo above shows the wrap with liner layer installed



- Typically used to protect short indoor lengths of hot or cold piping and hoses. Excellent for steam and hot process pipes and hoses.
- Provides personnel contact burn protection and energy savings.
- Easy hook and loop closure works in either covering mode: longitudinal or spiral.
- Can be used longitudinally or spirally.
- “Lined” version has a PTFE coated fibreglass support fabric on the inside, protecting the insulation layer. Prevents the insulation fibers from damage if the wrap is removed and re-installed frequently. Also prevents moisture/liquids/contamination of the insulation which is absorbant.
- Available with 1/4” or 1/2” thick insulation layer. Other thicknesses available.
- Excellent for covering pipes with heater trace tapes installed.
- Excellent for labs as one width of wrap can insulate a variety of glass pipe or tube sizes when used in spiral mode.
- Can be used on large size pipes when spiral wrapped or added to other tapes in parallel.
- Insulation layer meets MIL-I-24244. Outer silicone coated fabric meets UL214 and NFPA -701 and is available meeting MIL-I-24244 and NRC 1.36.
- The standard hook and loop closure (rated to +250°F) is positioned above the contact point by the insulation layer thickness, allowing it to be used with hotter contact temperatures. Nomex® (rated to +350°F) and Stainless Steel hook and loop is available as an option.

The wrap may be used longitudinally, or spiral wrapped. In these photos, the wrap has no liner installed.



**Insulated Wrap Tape - InsulSave™ (Continued)  
For Pipe / Hose / Cable Protection. High Thermal Insulation Value  
Provides burn protection for personnel working near hot pipes & hoses**

500°F / 260°C: suitable for steam and process piping/hoses – hot or cold protection and energy savings. Useable from -67°F (-55°C) to +500°F (260°C)



InsulSave™ Insulated Pipe Wrap Tape - Roll Length 20 feet with Nylon hook and loop closure. Nomex® hook & loop add \$178.00. Stainless Steel hook and loop add \$920.00.			
Part Number	Nominal Pipe Size / Actual Pipe OD (when used lengthwise)	1/4" Insulation no liner / with liner "X" = 25	1/2" insulation no liner / with liner "X" = 50
FAB-INSULSAVE-ID025-THK-X-Y-Z	¼" / 0.54"	\$ 176.12 / N/A	\$ 212.43 / N/A
FAB-INSULSAVE-ID050-THK-X-Y-Z	½" / 0.84"	\$ 200.34 / \$ 262.92	\$ 232.77 / \$ 325.64
FAB-INSULSAVE-ID075-THK-X-Y-Z	¾" / 1"	\$ 215.67 / \$ 292.85	\$ 251.68 / \$ 351.14
FAB-INSULSAVE-ID100-THK-X-Y-Z	1" / 1.31"	\$ 245.63 / \$ 336.76	\$ 280.13 / \$ 397.43
FAB-INSULSAVE-ID150-THK-X-Y-Z	1 ½" / 1.9"	\$ 286.21 / \$ 396.83	\$ 319.24 / \$ 452.63
FAB-INSULSAVE-ID200-THK-X-Y-Z	2" / 2.375"	\$ 323.47 / \$ 444.81	\$ 361.07 / \$ 517.28
FAB-INSULSAVE-ID250-THK-X-Y-Z	2 ½" / 2.87"	\$ 354.75 / \$ 511.17	\$ 400.51 / \$ 573.58
FAB-INSULSAVE-ID300-THK-X-Y-Z	3" / 3.5"	\$ 411.07 / \$ 574.33	\$ 454.53 / \$ 654.73
FAB-INSULSAVE-ID350-THK-X-Y-Z	3 ½" / 4"	\$ 432.32 / \$ 632.66	\$ 479.63 / \$ 688.54
FAB-INSULSAVE-ID400-THK-X-Y-Z	4" / 4.5"	\$ 481.47 / \$ 699.54	\$ 543.29 / \$ 771.28

**Other sizes and insulation thickness versions available – please call**

This product will reduce the surface temperature of the wrap to a level which depends on the temperature of the inner pipe or hose and the thickness of the insulation layer. For thinner insulation layers, the surface temperature will be higher than for thicker layers. The standard nylon hook and loop closure can be used for surface temperatures up to 250°F continuous (300°F for 1 hour – melts at 450°F). For higher temperatures a Nomex® hook and loop closure can be used which can be used up to 350°F continuous. For temperatures between 350°F and 500°F a stainless steel hook and loop is available or the wrap can be used without hook and loop closure and instead use our free-end stainless steel cable ties to secure it. To approximately determine the surface temperature please see the next page in the catalog.

**This is a fabricated item: please allow 5 days for production**

For the "X" value, use:

"25" for .25" thick insulation; "50" for .50" thick insulation

For the "Y" value, use: "NL" for No Liner; "WL" for With Liner

For the "Z" value, use: "NY" for Nylon; "NM" for Nomex; "SS" for Stainless Steel

## InsulSave™ Insulated Wrap Tape Thermal Profile Information

### Determining if this product can be used to protect personnel from hot pipe/hose burns

Under OSHA requirements, there is no specific temperature that a pipe or hose or other hot item must be at or below to consider it safe for contact. The OSHA regulations state that steam and hot water pipes shall be covered with insulation or be guarded.

It has generally been accepted by workplace health and safety professionals that metallic items that are above 140°F / 60°C should be protected in a manner so that accidental contact will not produce a burn. Therefore, a target temperature of 140°F / 60°C and below is desirable for metallic objects. Therefore one can also think that any insulation system on a hot pipe or hose should therefore also have a maximum surface temperature of 140°F / 60°C.

There is a standard, UL2200, which does provide some specific temperature numbers for use with engine driven generators, and of interest they differentiate metallic from non-metallic items. It is important to remember that metals conduct heat, and most thermal protection systems (insulation, fabrics, tapes, etc.), do not. This means that the insulation system surface can be “hotter” than a metal surface and still be “touch safe”.

So the maximum temperature that the surface of an insulation system can be at should be below 203°F / 95°C for accidental or casual brush-by contact.

Location	Composition of surface <sup>a</sup>	
	Metal	Nonmetallic
Handles or knobs that are grasped for holding	50• C (122• F)	60• C (140• F)
Handles or knobs that are contacted and do not involve holding; and other surfaces subject to contact and user maintenance	60• C (140• F)	85• C (185• F)
Surfaces subject to casual contact <sup>a</sup>	70• C (158• F)	95• C (203• F)
<sup>a</sup> A handle, knob, or similar device, made of a material other than metal that is plated or clad with metal having a thickness of 0.005 inch (0.127 mm) or less is judged as a nonmetallic part. <sup>b</sup> See the Exception to 38.3.		

UL2200 temperature limits

The information on the next page provides more information to help determine what thickness of insulation may result in a pipe wrap that will provide the desired temperature drop from the surface of the pipe to the surface of the pipe wrap.

It can be seen that the ½” thick insulation can provide, for example, a suitable drop for pipes operating up to 500°F and that the standard nylon hook and loop is suitable at the surface temperature of 203°F.

Thinner ¼” insulation would provide less of a temperature differential while the ¾ “ insulation would provide more differential. This information should only be used as a guideline and every installation will be different. The information presented should help you to determine if you are on the correct path to determining the best solution to meet your needs.

**InsulSave™ Insulated Wrap Tape Thermal Profile Information (Continued)**  
**500°F / 260°C: InsulSave™ Easy to use pipe wrap for steam and process piping/hoses – hot or cold protection and energy savings.**  
 Useable from -67°F (-55°C) to +500°F (260°C)

**Insulation Properties of the Insulated Wrap Tape**

Physical Properties		Properties of Fiberglass "E" Glass	
Service Temperature	Up to 1200°F	<b>Physical/Mechanical Properties of Glass Fibers</b>	
Fire Resistance	Incombustible	Specific Gravity	2.60 grams/cc
Density (Approximate)	9 lbs./cu. ft.	Density	0.094 lbs./cu. in.
Moisture Absorption	Negligible	Tensile Strength (PSI x 10 <sup>3</sup> @ 70°F)	500 lbs.
<b>Thermal Conductivity ("K" value at 9.1 lbs./cu. ft.):</b>		Modulus of Elasticity (PSI x 10 @ 72°F)	10.5 lbs.
Mean Temperature	"K" - btu/sq. ft./hr./°F/in.	After Heating (PSI x 10 @ 1000°F)	11.8 lbs.
300°F	0.40	Elongation @ 72°F	4.8%
500°F	0.50	<b>Thermal Properties of Bulk Glass</b>	
700°F	0.65	Softening Point	1500°F
<b>Thermal Conductivity (btu/sq ft/hr/°F/in)</b>		Strain Point	1100°F
		Annealing Point	1200°F
		<b>Electrical Properties of Bulk Glass</b>	
		Dielectric Constant	
		1 MHz @ 72°F	6.33
		10kHz @ 72°F	6.13
		Power Factor	
		1MHz @ 72°F	0.001
		10kHz @ 72°F	0.0030

**Note:** The physical and performance properties cited in this literature have been derived in tests conducted by various fiber companies. Tests have been conducted on both fiber and fabrics woven with bulked glass fiber. Reference to U.S. Government specification values as well as information provided on certain end uses which currently use bulked glass are presented for the information of potential customers in determining the potential suitability of these products for their own applications. No claims are made as to the accuracy or applicability of the test methods employed or the results derived therefrom.

**Important Cautionary Note:** Items of protective equipment manufactured from fiberglass fabrics such as aprons, gloves, mittens, etc. should be labeled to show the maximum short-term and continuous-exposure temperature limits established in accordance with the standard specifications applicable to the item of equipment being offered.

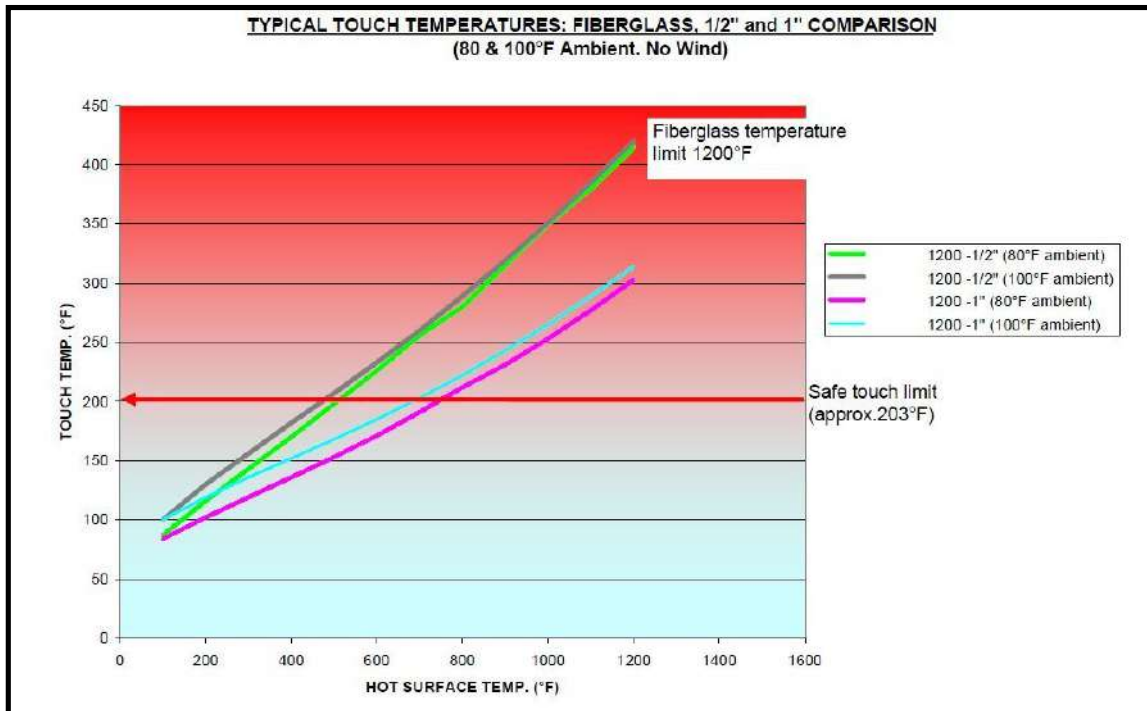

## FlangeStik™ Pressure Sensitive Adhesive Spray for Tape Mounting



- Covers approximately 90 to 100 square feet. (enough for mounting a quantity of five 2" wide x 100 foot tapes for example)
- Used for temporary mounting of tapes onto flanges, gasket channels or contact areas while permanent hardware is installed.
- Available in butyl rubber adhesive or silicone adhesive.
- Greatly assists in the installation of tapes and fabrics onto metal and non-metal surfaces.
- 340g (12oz) net contents.
- Ships ground only.

### FlangeStik™ Pressure Sensitive Adhesive Spray for Tape and Fabric Mounting

Part Number	Adhesive	Price
AD-PSA-BR-340-12	Butyl rubber	26.64
AD-PSA-US-340-12	Silicone	Call

## FlangeStik™ Pressure Sensitive Adhesive Mounting Tape

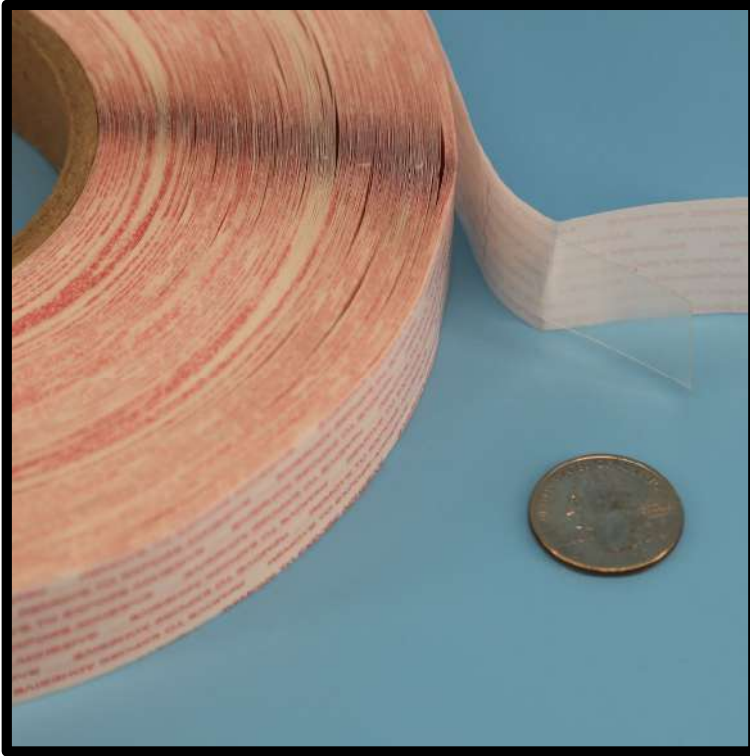

- 1" wide backing paper with 0.75" wide adhesive mounting tape PSA layer.
- Backing paper is white, PSA film is transparent.
- Adhesive is hot melt rubber based.
- Used for temporary mounting of tapes onto flanges, gasket channels or contact areas while permanent hardware is installed.
- Greatly assists in the installation of tapes and fabrics onto metal and non-metal surfaces.
- Roll lengths are 1600 and 100 feet.
- Total thickness is 0.0059". Liner is 0.0028" thick. Adhesive film is 0.0031" thick
- Service temperature is 32°F to 158°F. Should be applied at 50°F to 122°F.

FlangeStik™ Pressure Sensitive Mounting Tape			
Part Number	Adhesive	Roll Length	Price
T-AD-PSA-TAPE-1600	Butyl rubber	1600 feet	\$ 276.47
T-AD-PSA-TAPE-100	Butyl rubber	100 feet	\$ 34.55



## BoltHole™ / LadderTape™ / BoltLine™ Drop-Warp style tapes

Specifically designed for flange and access panel bolt lines.  
Fiberglass, Prosil, Silica & Ceramic Materials

1200°F / 648°C to 2000°F / 1093°C



These tapes will not burn and will withstand continuous exposure to temperatures ranging from 1200°F / 648°C to 2000°F / 1093°C .

Offered in both Knit and Woven construction. Knitted tapes are extremely flexible and highly conformable, much more so than the same dimension tape in a woven style.

Fastening bolts pass easily through the center of the tape where some of the warp yarns are omitted during tape manufacturing.

A Heat Treated version of this product is available – please enquire.

Tapes with PSA available for ease of installation.

Very High Temperature & Heat Resistant BoltHole™ // LadderTape™ / Drop-Warp style - Premium Grades							
1/16" / 1.5 mm Thick / Drop-Warp - BoltHole™ - LadderTape™							
Part Number	Width inch / mm		Price per Roll				
			WFG 1200°F	WP 1350°F	WFGVC 1500°F	WS 1800°F	WC 2000°F
T-BHLT-1.000-M025-A-X	1"	25	\$ 36.73	\$36.84	\$82.93	\$177.00	\$43.70
T-BHLT-1.250-M032-A-X	1 1/4"	32	\$ 38.73	NA	\$85.57	NA	NA
T-BHLT-1.500-M038-A-X	1 1/2"	38	\$ 40.13	\$52.29	\$87.50	\$247.00	NA
T-BHLT-1.750-M044-A-X	1 3/4"	44	\$ NA	NA	NA	NA	NA
T-BHLT-2.000-M051-A-X	2"	51	\$ 44.73	\$67.80	\$93.67	\$321.00	\$78.20
T-BHLT-2.500-M064-A-X	2 1/2"	64	\$ 49.86	\$83.34	\$100.67	NA	NA
T-BHLT-3.000-M076-A-X	3"	76	\$ 58.23	\$98.64	\$111.93	\$472.00	\$112.70
T-BHLT-4.000-M102-A-X	4"	102	\$ 75.60	\$129.57	\$135.40	\$605.00	\$141.45
T-BHLT-5.000-M127-A-X	5"	127	\$ 92.73	\$174.84	\$157.75	NA	NA

Each roll contains 100 feet / 30 metres.

For the "X" value specify: either  
"WFG" for Woven Fiberglass, "WP" for Prosil,  
"WFGVC" for Vermiculite Coated Fiberglass, "WS" for Silica, "WC" for Ceramic

**This Product is NOT Available By-The-Foot – Full Rolls Only**

**BoltHole™ / LadderTape™ (Continued)**

Very High Temperature & Heat Resistant BoltHole™ / Drop-Warp / LadderTape™ - Premium Grades								
1/8" / 3 mm Thick / Drop-Warp - BoltHole™ - LadderTape™								
Part Number	Width inch / mm		Price per Roll					
			KFG 1200°F	WFG 1200°F	WP 1350°F	WFGVC 1500°F	WS 1800°F	WC 2000°F
T-BHLT-1.000-M025-B-X	1"	25	\$61.67	\$ 58.44	\$75.15	\$99.83	\$402.00	\$59.80
T-BHLT-1.250-M032-B-X	1 1/4"	32	\$78.33	\$ 59.73	NA	\$111.27	NA	NA
T-BHLT-1.500-M038-B-X	1 1/2"	38	\$90.00	\$ 60.55	\$106.29	\$114.58	\$564.00	88.55
T-BHLT-1.750-M044-B-X	1 3/4"	44	\$100.00	\$ NA	NA	NA	NA	NA
T-BHLT-2.000-M051-B-X	2"	51	\$110.00	\$ 70.80	\$139.22	\$128.90	\$741.00	\$106.95
T-BHLT-2.500-M064-B-X	2 1/2"	64	\$133.33	\$ 82.20	\$172.50	\$144.31	NA	NA
T-BHLT-3.000-M076-B-X	3"	76	\$163.33	\$ 99.20	\$205.62	\$167.03	\$1109.00	\$154.10
T-BHLT-4.000-M102-B-X	4"	102	\$210.00	\$ 123.16	\$271.71	\$198.20	\$1492.00	\$193.20
T-BHLT-5.000-M127-B-X	5"	127	\$260.00	\$ 169.93	\$353.13	\$262.73	NA	NA

Each roll contains 100 feet / 30 metres.

For the "X" value specify: either  
 "KF" for Knit Fiberglass, "WF" for Woven Fiberglass, "WP" for Prosil,  
 "FGVC" for Vermiculite Coated Fiberglass, "S" for Silica, "C" for Ceramic

This Product is NOT Available By-The-Foot – Full Rolls Only

Very High Temperature & Heat Resistant BoltHole™ / Drop-Warp / LadderTape™ - Premium Grades								
1/4" / 6 mm Thick / Drop-Warp - BoltHole™ - LadderTape™								
Part Number	Width inch / mm		Price per Roll					
			WF 1200°F	WP 1350°F	FGVC 1500°F	S 1800°F	C 2000°F	
T-BHLT-1.000-M025-C-X	1"	25	\$	\$	\$	\$	\$	\$
T-BHLT-1.250-M032-C-X	1 1/4"	32	\$	NA	\$	NA	NA	NA
T-BHLT-1.500-M038-C-X	1 1/2"	38	\$	\$	\$	\$	NA	NA
T-BHLT-1.750-M044-C-X	1 3/4"	44	\$ NA	NA	NA	NA	NA	NA
T-BHLT-2.000-M051-C-X	2"	51	\$	\$	\$	\$	\$	\$
T-BHLT-2.500-M064-C-X	2 1/2"	64	\$	\$	\$	NA	NA	NA
T-BHLT-3.000-M076-C-X	3"	76	\$	\$	\$	\$	\$	\$
T-BHLT-4.000-M102-C-X	4"	102	\$	\$	\$	\$	\$	\$
T-BHLT-5.000-M127-C-X	5"	127	\$	\$	\$	NA	NA	NA

To aid in mounting this tape onto surfaces, FlangeStik™ pressure sensitive adhesive spray can be used to place the tape in situ temporarily. Permanent fasteners or grab strips should be installed prior to heating of the area sprayed above 200°F. The adhesive will "smoke-off" at elevated temperatures.



**Thermal, EMI/RFI & Abrasion Protection Materials**

Fax Orders: 610-340-9054 Telephone Orders: 610-906-3549 [orders@abthermal.com](mailto:orders@abthermal.com)

---

# TadpoleTape™

500°F / 260°C Silicone Rubber Coated Stainless Mesh TadpoleTape™ .....	2-126
320°F / 160°C Aramid High Strength TadpoleTape™ .....	2-127
1200°F / 648°C Precision Fiberglass TadpoleTape™ .....	2-128
1200°F / 648°C Fiberglass Heavy Duty TadpoleTape™: with Rope or Wire Mesh Core .....	2-129
1350°F / 732°C ProSil™ Silica/Glass Blended Fabric Heavy Duty TadpoleTape™: with Rope or Wire Mesh Core .....	2-130
1350°F / 732°C ProSilMax™ Silica/Glass Blended Fabric with wire insert Heavy Duty TadpoleTape™: with Rope or Wire Mesh Core .....	2-131
1500°F / 815°C Fiberglass with Vermiculite Coating Heavy Duty TadpoleTape™: with Rope or Wire Mesh Core .....	2-132
1800°F / 982°C InSilMax™ Heavy Duty TadpoleTape™: with Rope or Wire Mesh Core .....	2-133
1900°F / 1037°C InSilMax™ XT Heavy Duty TadpoleTape™: with Rope or Wire Mesh Core .....	2-134
2000°F / 1093°C CerMax™ Heavy Duty TadpoleTape™: with Rope or Wire Mesh Core .....	2-135

## Tadpoles with Specialized Coatings

550°F / 287°C Fiberglass with PTFE Coating Heavy Duty TadpoleTape™: with Rope or Wire Mesh Core .....	2-137
550°F / 287°C Rubberized Fiberglass Tacky Cloth Heavy Duty TadpoleTape™: with Rope or Wire Mesh Core .....	2-138
550°F / 287°C Expanded PTFE Heavy Duty TadpoleTape™: with Rope or Wire Mesh Core .....	2-139
TT WearGuard .....	2-140

## CUSTOM SIZED TADPOLE GASKET TAPE

The catalogue pages for tadpole gasket tapes show our line of standard materials and sizes that are made by our fabrication shop.

Our tadpole gasket fabrication shop can manufacture tadpoles of almost size and shape using our standard materials, or from other materials not normally used.

Please feel free to request a quote; either a description, or a drawing, or a photo is useful. If you would like us to match materials to an existing tadpole that needs replacement, then either a detailed close-up photo or a sample would be very useful.

Please send quote requests to [info@abthermal.com](mailto:info@abthermal.com) or call the order desk at 610-906-3549.

## High Temperature Silicone Rubber Coated Stainless Steel Mesh Tadpole Gasket Seals 500°F / 260°C

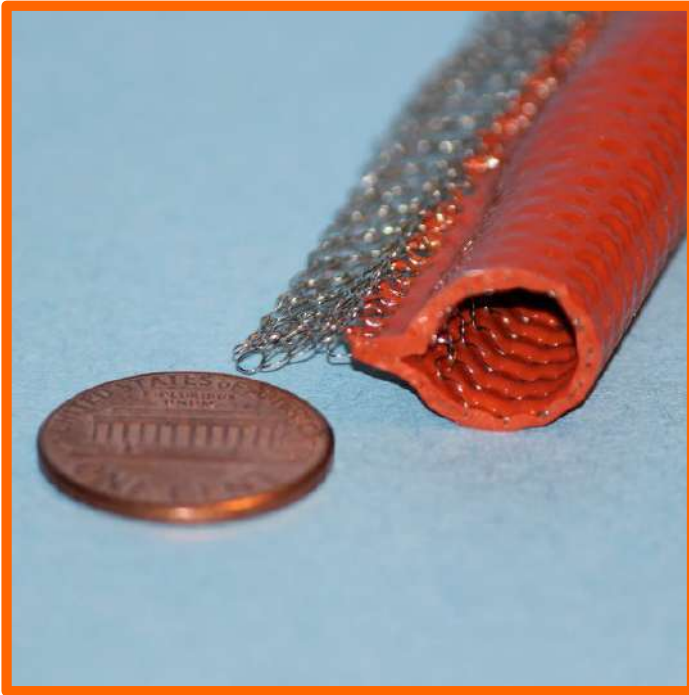

Can be used for applications up to 500°F / 260°C continuous rating with weld splatter / molten metal splash protection. These silicone rubber products provide excellent cold temperature performance with flexibility to -76°C for refrigeration and cryogenic applications.

Excellent sealing against liquids and gases.

TT-SS-SR-0.937-0.437 is a 15/16" overall width tadpole with a 7/16" OD bulb. It is a common tadpole to use in cryogenic freezing access doors, such as food processing freezing and packaging lines.

<b>High Temperature &amp; Heat Resistant Silicone Rubber Tadpole Gasket Tape</b>			
<b>Part Number</b>	<b>Feet / Metres per Spool</b>	<b>Price per spool</b>	<b>Price per foot</b>
TT-SS-SR-0.937W-0.437B	100 / 30.48	\$ 670.00	\$ 15.41



## Aramid (Aromatic Polyamide) Tadpole Tape with Aramid Rope or Wire Mesh Bulb Core

320°F / 160°C TadpoleTape™ High Temperature, Heat Resistant & High Strength



Made from our aramid fabrics and ropes, and metallic mesh ropes, this is a soft and resilient gasket material for effective sealing on light metal flanges and where limited bolting force is available – and where doors and other closures rest on the bulb. The aramid fabric is very abrasion and cut resistant, ideal for high cycle applications. Not suitable for applications involving prolonged sunlight or UV exposure.

Available By-The-Foot or in standard rolls of 50 and 100 feet. **This product has a \$250 minimum order value.**

Kevlar® is a popular brand name of an Aramid polyamide material from DuPont. Our Aramid is not a DuPont product.

This product is highly flexible and conformable.

### TadpoleTape™ High Temperature & Heat Resistant Aramid with Aramid Rope Core

Part Number	Over All Width in / mm	Price per Foot By Bulb Size: A / B / C / D / E in / mm				
		"A"	"B"	"C"	"D"	"E"
		3/8" / .375 / 7.9	1/2" / .500 / 13	5/8" / .625 / 15.8	3/4" / .750 / 19	1" / 1.000 / 25
TT-A-RC-M025-16-X	1.00 / 25	\$ 8.40	\$ 9.24	\$ N/A	N/A	N/A
TT-A-RC-M032-20-X	1.25 / 32	\$ 8.64	\$ 9.60	\$ 11.04	\$ 11.66	N/A
TT-A-RC-M038-24-X	1.50 / 38	\$ 9.24	\$ 9.96	\$ 11.40	\$ 12.50	N/A
TT-A-RC-M044-28-X	1.75 / 44	\$ 9.60	\$ 10.32	\$ 12.00	\$ 13.08	\$ 18.64
TT-A-RC-M051-32-X	2.00 / 51	\$ 9.72	\$ 11.04	\$ 12.84	\$ 13.44	\$ 19.32
TT-A-RC-M063-40-X	2.50 / 63	\$ 10.92	\$ 11.88	\$ 13.92	\$ 14.40	\$ 20.40
TT-A-RC-M076-48-X	3.00 / 76	\$ 11.88	\$ 12.72	\$ 14.34	\$ 15.48	\$ 21.12

### TadpoleTape™ High Temperature & Heat Resistant Aramid with Stainless Steel or Inconel 600 Mesh Core

Part Number	Over All Width in / mm	Price per Foot By Bulb Size: A / B / C / D / E in / mm				
		"A"	"B"	"C"	"D"	"E"
		3/8" / .375 / 7.9 SS / Inconel	1/2" / .500 / 13 SS / Inconel	5/8" / .625 / 15.8 SS / Inconel	3/4" / .750 / 19 SS / Inconel	1" / 1.000 / 25 SS / Inconel
TT-A-MC-M025-16-X-Z	1.00 / 25	\$11.68 / \$14.16	\$12.48 / \$16.40	N/A	N/A	N/A
TT-A-MC-M032-20-X-Z	1.25 / 32	\$11.84 / \$14.32	\$12.64 / \$16.64	\$16.96 / \$18.08	\$16.12 / \$19.12	NA
TT-A-MC-M038-24-X-Z	1.50 / 38	\$12.08 / \$14.40	\$12.88 / \$16.96	\$17.12 / \$18.32	\$16.56 / \$19.60	NA
TT-A-MC-M044-28-X-Z	1.75 / 44	\$12.40 / \$14.96	\$13.12 / \$17.28	\$17.52 / \$18.64	\$17.68 / \$20.40	\$20.64 / \$22.28
TT-A-MC-M051-32-X-Z	2.00 / 51	\$12.56 / \$15.44	\$13.52 / \$17.76	\$18.08 / \$19.20	\$18.30 / \$21.56	\$21.55 / \$23.48
TT-A-MC-M063-40-X-Z	2.50 / 63	\$13.20 / \$16.16	\$13.92 / \$18.40	\$18.80 / \$19.76	\$19.76 / \$22.92	\$22.72 / \$24.80
TT-A-MC-M076-48-X-Z	3.00 / 76	\$13.76 / \$16.72	\$14.48 / \$19.60	\$19.68 / \$20.96	\$21.23 / \$23.64	\$23.80 / \$25.40

For the "X" value: specify either A, B, C, D, or E  
For the "Z" value: specify "S" for Stainless Steel or "I" for Inconel

**OTHER CUSTOM SIZES & SHAPES AVAILABLE – PLEASE INQUIRE**

**Precision Fiberglass Tadpole Gasket Tape**  
**Oven / Stove / Boiler / Kiln / Paint Booth / Clean Room Door Seals**  
**1200°F / 648°C TadpoleTape™ Very High Temperature & Heat Resistant**

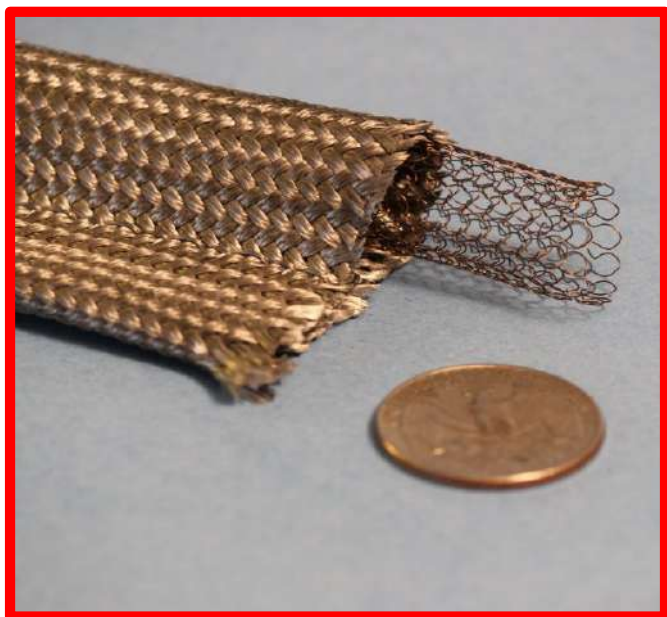

- Precision Tadpole with consistent dimension of bulb and tail.
- Small tail is hollow, and can be supplied filled with a cord or rope to use as a mounting point with slotted metalwork.
- High pushback 304 stainless steel hollow sleeve inside of bulb provides excellent pushback with low compression set.
- Heat treated to result in an extremely clean surface that sheds extremely few fibers and no organic odors. Suitable for paint booth and food service applications.
- Fabricated from high quality type E fiberglass that will not burn and will withstand continuous exposure to temperatures of 1200°F / 648°C.
- This product resists most acids and alkalis and is unaffected by most bleaches and solvents. It is highly flexible and conformable. The base fiber is manufactured to the specifications of ASTM D-578, ASTM committee D13, and subcommittee D13.18.

- Two sizes available:
- 1) 1 3/8 inch OAW (Over All Width) with a 5/8" Bulb with hollow 304 stainless steel mesh core bulb material, with 3/4" tail. The knitted wire mesh core provides excellent compression and pushback and high cycle life. ID of the hollow metal mesh bulb core is 1/2 inch.
  - 2) 1 1/4 inch OAW (Over All Width) with a 1/2" Bulb with hollow 304 stainless steel mesh core bulb material, with 3/4" tail. The knitted wire mesh core provides excellent compression and pushback and high cycle life. ID of the hollow metal mesh bulb core is 7/16 inch.

<b>Very High Temperature &amp; Heat Resistant Heat Treated Fiberglass Precision Tadpole Gasket Tape with Hollow Stainless Steel Knit Mesh Core</b>			
<b>Part Number</b>	<b>Bulb Size</b>	<b>Feet / Metres per coil</b>	<b>Price per coil / foot</b>
TT-FG-HSSMC-M013-08-25-X	1/2"	25 / 7.6	\$ 173.25 per coil
TT-FG HSSMC-M013-08-50-X	1/2"	50 / 15.2	\$ 346.50 per coil
TT-FG HSSMC-M013-08-250-X	1/2"	250 / 76.2	\$ 1218.64 per coil
TT-FG HSSMC-M013-08-BTF-X	1/2"	By The Foot	\$ 10.40 / foot
TT-FG-HSSMC-M016-10-25-X	5/8"	25 / 7.6	\$ 198.66 per coil
TT-FG HSSMC-M016-10-50-X	5/8"	50 / 15.2	\$ 361.73 per coil
TT-FG HSSMC-M016-10-250-X	5/8"	250 / 76.2	\$ 1455.62 per coil
TT-FG HSSMC-M016-10-BTF-X	5/8"	By The Foot	\$ 12.38 / foot

Genuine TadpoleTape™ gasket is designed to provide a high temperature thermal seal in industrial, laboratory and commercial ovens and dryers. Used on residential self cleaning ovens as a door gasket seal.

Custom sized tadpole gasket tapes are available



## Fiberglass Tadpole Tape with Fiberglass Rope or Wire Mesh Bulb Core 1200°F / 648°C TadpoleTape™ Very High Temperature & Heat Resistant



Made from our heavy duty fiberglass fabrics and ropes, and metallic mesh ropes, this is a soft and resilient gasket material for effective sealing on light metal flanges and where limited bolting force is available – and where doors and other closures rest on the bulb.

Standard Rolls of 50 and 100 feet. For By-The-Foot pricing add 25% to price shown. **This product has a \$25 minimum order value.**

A Heat Treated version of this product is available for clean room door sealing – please enquire

Fabricated from high quality type E fiberglass that will not burn and will withstand continuous exposure to temperatures of 1200°F / 648°C. This product resists most acids and alkalis and is unaffected by most bleaches and solvents. It is highly flexible and conformable.

### TadpoleTape™ Very High Temperature & Heat Resistant Fiberglass with Rope Core

Part Number	Over All Width in / mm	Price per Foot By Bulb Size: A / B / C / D / E				
		in / mm				
		"A" 3/8" / .375 / 7.9	"B" 1/2" / .500 / 13	"C" 5/8" / .625 / 15.8	"D" 3/4" / .750 / 19	"E" 1" / 1.000 / 25
TT-FG-RC-M025-16-X	1.00 / 25	\$ 2.80	\$ 3.08	\$ 3.48	NA	NA
TT-FG-RC-M032-20-X	1.25 / 32	\$ 2.88	\$ 3.20	\$ 3.68	NA	NA
TT-FG-RC-M038-24-X	1.50 / 38	\$ 3.08	\$ 3.32	\$ 3.80	\$ 4.20	NA
TT-FG-RC-M044-28-X	1.75 / 44	\$ 3.20	\$ 3.44	\$ 4.00	\$ 4.36	\$ 6.88
TT-FG-RC-M051-32-X	2.00 / 51	\$ 3.24	\$ 3.68	\$ 4.28	\$ 4.48	\$ 6.44
TT-FG-RC-M063-40-X	2.50 / 63	\$ 3.64	\$ 3.96	\$ 4.68	\$ 4.80	\$ 6.80
TT-FG-RC-M076-48-X	3.00 / 76	\$ 3.96	\$ 4.24	\$ 4.64	\$ 5.16	\$ 7.04

### TadpoleTape™ Very High Temperature & Heat Resistant Fiberglass with Stainless Steel or Inconel 600 Mesh Core

Part Number	Over All Width in / mm	Price per Foot By Bulb Size: A / B / C / D / E				
		in / mm				
		"A" 3/8" / .375 / 7.9 SS / Inconel	"B" 1/2" / .500 / 13 SS / Inconel	"C" 5/8" / .625 / 15.8 SS / Inconel	"D" 3/4" / .750 / 19 SS / Inconel	"E" 1" / 1.000 / 25 SS / Inconel
TT-FG-MC-M025-16-X-Z	1.00 / 25	\$5.84 / \$7.08	\$6.24 / \$8.20	\$8.32 / NA	NA	NA
TT-FG-MC-M032-20-X-Z	1.25 / 32	\$5.92 / \$7.16	\$6.32 / \$8.32	\$8.48 / \$9.04	NA	NA
TT-FG-MC-M038-24-X-Z	1.50 / 38	\$6.04 / \$7.20	\$6.44 / \$8.48	\$8.56 / \$9.16	\$12.56 / \$18.20	NA
TT-FG-MC-M044-28-X-Z	1.75 / 44	\$6.20 / \$7.48	\$6.56 / \$8.64	\$8.76 / \$9.32	\$12.68 / \$18.40	\$20.64 / \$22.28
TT-FG-MC-M051-32-X-Z	2.00 / 51	\$6.28 / \$7.72	\$6.76 / \$8.88	\$9.04 / \$9.60	\$12.80 / \$18.56	\$20.64 / \$22.48
TT-FG-MC-M063-40-X-Z	2.50 / 63	\$6.60 / \$8.08	\$6.96 / \$9.20	\$9.40 / \$9.88	\$13.20 / \$18.92	\$20.72 / \$22.80
TT-FG-MC-M076-48-X-Z	3.00 / 76	\$6.88 / \$8.36	\$7.24 / \$9.80	\$12.84 / \$10.48	\$13.40 / \$19.64	\$20.80 / \$23.40

For the "X" value: specify either A, B, C, D, or E  
For the "Z" value: specify "S" for Stainless Steel or "I" for Inconel

**OTHER CUSTOM SIZES & SHAPES AVAILABLE – PLEASE INQUIRE**

## ProSil™ Silica/Glass Blended Fabric Tadpole Tape with Rope or Wire Mesh Core

1350°F / 732°C TadpoleTape™ High Temperature & Heat Resistant



Made from our proprietary blended silica/fiberglass heavy duty fabric, this is a soft and resilient gasket material for effective sealing on metal flanges and where limited bolting force is available – and where doors and other closures rest on the bulb.

Outperforms standard fiberglass tadpole tapes in higher temperature applications. Remains soft and workable at temperatures where fiberglass tapes become brittle

Standard Rolls of 50 and 100 feet. For By-The-Foot pricing add 25% to price shown. **This product has a \$200 minimum order value.**

1350°F / 732°C continuous rating: Highly flexible and conformable.

### TadpoleTape™ Very High Temperature & Heat Resistant ProSil™ Blended Silica/Glass with Rope Core

Part Number	Over All Width in / mm	Price per Foot By Bulb Size: A / B / C / D / E (in / mm)				
		Rope Core / Inconel Mesh Core				
		"A" 3/8" / 7.9	"B" 1/2" / 13	"C" 5/8" / 15.8	"D" 3/4" / 19	"E" 1" / 25
TT-FGS-RC-M025-16-X	1.00 / 25	\$ 5.90	\$ 6.46	NA	NA	NA
TT-FGS-RC-M032-20-X	1.25 / 32	\$ 6.00	\$ 6.86	\$ 7.46	\$ 8.57	NA
TT-FGS-RC-M038-24-X	1.50 / 38	\$ 6.70	\$ 7.30	\$ 7.90	\$ 8.96	NA
TT-FGS-RC-M044-28-X	1.75 / 44	\$ 7.13	\$ 7.66	\$ 8.26	\$ 9.40	\$ 11.20
TT-FGS-RC-M051-32-X	2.00 / 51	\$ 7.50	\$ 8.10	\$ 8.70	\$ 9.80	\$ 11.56
TT-FGS-RC-M063-40-X	2.50 / 63	\$ 8.33	\$ 8.90	\$ 9.50	\$ 10.63	\$ 12.36
TT-FGS-RC-M076-48-X	3.00 / 76	\$ 9.13	\$ 9.70	\$ 10.30	\$ 11.46	\$ 13.20

For the "X" value: specify either A, B, C, D, or E

### TadpoleTape™ Very High Temperature & Heat Resistant ProSil™ Blended Silica/Glass with Inconel 600 Mesh Core

Part Number	Over All Width in / mm	Price per Foot By Bulb Size: A / B / C / D / E (in / mm)				
		Rope Core / Inconel Mesh Core				
		"A" 3/8" / 7.9	"B" 1/2" / 13	"C" 5/8" / 15.8	"D" 3/4" / 19	"E" 1" / 25
TT-FGS-MC-M025-16-X	1.00 / 25	\$ 8.63	\$ 9.10	\$ NA	NA	NA
TT-FGS-MC-M032-20-X	1.25 / 32	\$ 9.43	\$ 9.86	\$ 10.80	\$ 15.23	NA
TT-FGS-MC-M038-24-X	1.50 / 38	\$ 9.86	\$ 10.73	\$ 11.23	\$ 15.53	NA
TT-FGS-MC-M044-28-X	1.75 / 44	\$ 10.26	\$ 11.13	\$ 11.60	\$ 16.00	\$ 17.96
TT-FGS-MC-M051-32-X	2.00 / 51	\$ 10.66	\$ 11.53	\$ 11.80	\$ 16.33	\$ 18.20
TT-FGS-MC-M063-40-X	2.50 / 63	\$ 11.46	\$ 12.33	\$ 12.83	\$ 17.10	\$ 18.50
TT-FGS-MC-M076-48-X	3.00 / 76	\$ 12.26	\$ 13.13	\$ 13.63	\$ 17.86	\$ 19.96

For the "X" value: specify either A, B, C, D, or E

**OTHER CUSTOM SIZES & SHAPES AVAILABLE – PLEASE INQUIRE**



**ProSilMax™ Silica/Glass Blended Fabric with Wire Insert  
Tadpole Tape with Rope or Wire Mesh Core  
1350°F / 732°C TadpoleTape™ High Temperature & Heat Resistant**



Made from our proprietary blended silica/fiberglass heavy duty fabric, this is a soft and resilient gasket material for effective sealing on metal flanges and where limited bolting force is available – and where doors and other closures rest on the bulb.

The fabric has a wire insert for additional strength and dimensional stability.

Outperforms standard fiberglass tadpole tapes in higher temperature applications. Remains soft and workable at temperatures where fiberglass tapes become brittle.

Standard Rolls of 50 and 100 feet. For By-The-Foot pricing add 25% to price shown. **This product has a \$200 minimum order value.**

1300°F / 704°C continuous rating: Highly flexible and conformable.

<b>TadpoleTape™ Very High Temperature &amp; Heat Resistant ProSilMax™ Blended Silica/Glass with Rope Core</b>						
Part Number	Over All Width in / mm	Price per Foot By Bulb Size: A / B / C / D / E (in / mm)				
		Rope Core / Inconel Mesh Core				
		"A" 3/8" / 7.9	"B" 1/2" / 13	"C" 5/8" / 15.8	"D" 3/4" / 19	"E" 1" / 25
TT-PROSIL-RC-M025-16-X	1.00 / 25	\$ 5.90	\$ 6.46	NA	NA	NA
TT-PROSIL-RC-M032-20-X	1.25 / 32	\$ 6.00	\$ 6.86	\$ 7.46	\$ 8.57	NA
TT-PROSIL-RC-M038-24-X	1.50 / 38	\$ 6.70	\$ 7.30	\$ 7.90	\$ 8.96	NA
TT-PROSIL-RC-M044-28-X	1.75 / 44	\$ 7.13	\$ 7.66	\$ 8.26	\$ 9.40	\$ 11.20
TT-PROSIL-RC-M051-32-X	2.00 / 51	\$ 7.50	\$ 8.10	\$ 8.70	\$ 9.80	\$ 11.56
TT-PROSIL-RC-M063-40-X	2.50 / 63	\$ 8.33	\$ 8.90	\$ 9.50	\$ 10.63	\$ 12.36
TT-PROSIL-RC-M076-48-X	3.00 / 76	\$ 9.13	\$ 9.70	\$ 10.30	\$ 11.46	\$ 13.20

For the "X" value: specify either A, B, C, D, or E

<b>TadpoleTape™ Very High Temperature &amp; Heat Resistant ProSilMax™ Blended Silica/Glass with Inconel 600 Mesh Core</b>						
Part Number	Over All Width in / mm	Price per Foot By Bulb Size: A / B / C / D / E (in / mm)				
		Rope Core / Inconel Mesh Core				
		"A" 3/8" / 7.9	"B" 1/2" / 13	"C" 5/8" / 15.8	"D" 3/4" / 19	"E" 1" / 25
TT-PROSIL-MC-M025-16-X	1.00 / 25	\$ 8.63	\$ 9.10	\$ NA	NA	NA
TT-PROSIL-MC-M032-20-X	1.25 / 32	\$ 9.43	\$ 9.86	\$ 10.80	\$ 15.23	NA
TT-PROSIL-MC-M038-24-X	1.50 / 38	\$ 9.86	\$ 10.73	\$ 11.23	\$ 15.53	NA
TT-PROSIL-MC-M044-28-X	1.75 / 44	\$ 10.26	\$ 11.13	\$ 11.60	\$ 16.00	\$ 17.96
TT-PROSIL-MC-M051-32-X	2.00 / 51	\$ 10.66	\$ 11.53	\$ 11.80	\$ 16.33	\$ 18.20
TT-PROSIL-MC-M063-40-X	2.50 / 63	\$ 11.46	\$ 12.33	\$ 12.83	\$ 17.10	\$ 18.50
TT-PROSIL-MC-M076-48-X	3.00 / 76	\$ 12.26	\$ 13.13	\$ 13.63	\$ 17.86	\$ 19.96

For the "X" value: specify either A, B, C, D, or E

**OTHER CUSTOM SIZES & SHAPES AVAILABLE – PLEASE INQUIRE**





## Vermiculite Coated Fiberglass Tadpole Tape / Rope or Wire Mesh Core 1500°F / 815°C TadpoleTape™ FlameShield™ 1500 High Temperature & Heat Resistant



Made from our heavy duty fabrics and ropes/wire mesh, this is a soft and resilient gasket material for effective sealing on light metal flanges and where limited bolting force is available – and where doors and other closures rest on the bulb of the packing.

Standard lengths of 50 and 100 feet. For By-The-Foot pricing: add 25% to price shown. **This product has a \$25 minimum order value.**

1500°F / 815°C continuous rating. Certified to meet the requirements of ASTM E 162, ASTM E 662 & SMP 800-C for surface flammability, smoke and toxic gas generation.

Fabricated from E fiberglass that will not burn and will withstand continuous exposure to temperatures of 1500°F / 815°C. This product resists most acids and alkalis and is unaffected by most bleaches and solvents. It is highly flexible and conformable. Meets Federal Railroad Administration requirements for surface flammability and rate of smoke generation.

TadpoleTape™ Vermiculite Coated Fiberglass with Rope Core						
Part Number	Over All Width in / mm	Price per Foot By Bulb Size: A / B / C / D / E				
		fractional inch / decimal inch / mm				
		"A" 3/8" / .375 / 7.9	"B" 1/2" / .500 / 13	"C" 5/8" / .625 / 15.8	"D" 3/4" / .750 / 19	"E" 1" / 1.000 / 25
TT-FG-VC-RC-M025-16-X	1.00 / 25	\$ 4.20	\$ 4.64	\$ 5.24	NA	NA
TT-FG-VC-RC-M032-20-X	1.25 / 32	\$ 4.36	\$ 4.80	\$ 5.52	NA	NA
TT-FG-VC-RC-M038-24-X	1.50 / 38	\$ 4.64	\$ 5.00	\$ 5.64	\$ 6.32	NA
TT-FG-VC-RC-M044-28-X	1.75 / 44	\$ 4.80	\$ 5.20	\$ 5.96	\$ 6.56	\$ 10.32
TT-FG-VC-RC-M051-32-X	2.00 / 51	\$ 4.88	\$ 5.52	\$ 6.44	\$ 6.76	\$ 10.56
TT-FG-VC-RC-M063-40-X	2.50 / 63	\$ 5.48	\$ 5.92	\$ 7.01	\$ 7.20	\$ 10.82
TT-FG-VC-RC-M076-48-X	3.00 / 76	\$ 5.92	\$ 6.36	\$ 7.32	\$ 7.72	\$ 11.05

TadpoleTape™ Vermiculite Coated Fiberglass with Stainless Steel or Inconel 600 Mesh Core						
Part Number	Over All Width in / mm	Price per Foot By Bulb Size: A / B / C / D / E				
		fractional inch / decimal inch / mm				
		"A" 3/8" / .375 / 7.9 SS / Inconel	"B" 1/2" / .500 / 13 SS / Inconel	"C" 5/8" / .625 / 15.8 SS / Inconel	"D" 3/4" / .750 / 19 SS / Inconel	"E" 1" / 1.00 / 25 SS / Inconel
TT-FG-VC-MC-M025-16-X-Z	1.00 / 25	\$7.36 / \$8.60	\$8.40 / \$9.16	\$9.36 / \$12.20	NA	NA
TT-FG-VC-MC-M032-20-X-Z	1.25 / 32	\$7.68 / \$8.72	\$8.72 / \$9.28	\$9.72 / \$12.48	NA	NA
TT-FG-VC-MC-M038-24-X-Z	1.50 / 38	\$7.80 / \$8.92	\$9.08 / \$9.44	\$10.04 / \$12.60	\$18.08 / \$18.48	NA
TT-FG-VC-MC-M044-28X-Z	1.75 / 44	\$8.32 / \$9.08	\$9.40 / \$9.60	\$10.60 / \$12.88	\$18.44 / \$18.64	\$22.12 / \$22.36
TT-FG-VC-MC-M051-32-X-Z	2.00 / 51	\$8.88 / \$9.20	\$9.84 / \$9.92	\$11.24 / \$13.32	\$18.92 / \$19.45	\$22.60 / \$22.87
TT-FG-VC-MC-M063-40-X-Z	2.50 / 63	\$9.52 / \$9.72	\$10.64 / \$10.24	\$12.40 / \$13.80	\$19.56 / \$19.81	\$23.24 / \$23.97
TT-FG-VC-MC-M076-48-X-Z	3.00 / 76	\$10.20 / \$10.12	\$11.76 / \$10.56	\$17.72 / \$18.84	\$20.98 / \$21.76	\$23.88 / \$24.56

For the "X" value: specify either A, B, C, D, or E for the bulb size  
 For the "Z" value: specify "S" for Stainless Steel or "I" for Inconel

**OTHER CUSTOM SIZES & SHAPES AVAILABLE – PLEASE INQUIRE**

## Silica Tadpole Tape With Rope or Wire Mesh Core 1800°F / 982°C InSilMax™ TadpoleTape™ Extreme High Temperature Heat Flame Resistant



Made from our heavy duty silica fabrics and ropes, this is a soft and resilient gasket material for effective sealing on light metal flanges and where limited bolting force is available – and where doors and other closures rest on the bulb of the packing.

Standard Rolls of 50 and 100 feet.

For “By-The-Foot” pricing: add 25% to price shown:

Can be used at 1800°F / 982°C continuously.

InSilMax™ TadpoleTape™ Extreme High Temperature; Heat & Flame Resistant With Rope Core						
Part Number	Over All Width in / mm	Price per Foot By Bulb Size: A / B / C / D / E in / mm				
		“A” 3/8” / .375 / 7.9	“B” 1/2” / .500 / 13	“C” 5/8” / .625 / 15.8	“D” 3/4” / .750 / 19	“E” 1” / 1.000 / 25
TT-S-RC-M025-16-X	1.00 / 25	\$ 7.64	\$ 7.92	\$ 9.64	NA	NA
TT-S-RC-M032-20-X	1.25 / 32	\$ 8.48	\$ 8.68	\$ 10.36	NA	NA
TT-S-RC-M038-24-X	1.50 / 38	\$ 8.72	\$ 9.24	\$ 11.40	\$ 12.44	NA
TT-S-RC-M044-28-X	1.75 / 44	\$ 9.32	\$ 10.08	\$ 12.28	\$ 13.08	\$ 15.92
TT-S-RC-M051-32-X	2.00 / 51	\$ 10.28	\$ 10.60	\$ 12.76	\$ 13.84	\$ 16.29
TT-S-RC-M063-40-X	2.50 / 63	\$ 11.52	\$ 11.96	\$ 13.40	\$ 15.40	\$ 16.87
TT-S-RC-M076-48-X	3.00 / 76	\$ 13.16	\$ 13.40	\$ 14.24	\$ 16.96	\$ 18.97

InSilMax™ TadpoleTape™ Extreme High Temperature; Heat & Flame Resistant with Stainless Steel or Inconel 600 Mesh Core						
Part Number	Over All Width in / mm	Price per Foot By Bulb Size: A / B / C / D / E in / mm and choice of Stainless Steel / Inconel Bulb				
		“A” 3/8” / .375 / 7.9 SS / Inconel	“B” 1/2” / .500 / 13 SS / Inconel	“C” 5/8” / .625 / 15.8 SS / Inconel	“D” 3/4” / .750 / 19 SS / Inconel	“E” 1” / 1.000 / 25 SS / Inconel
TT-S-MC-M025-16-X-Z	1.00 / 25	\$7.72 / \$8.40	\$8.60 / \$9.60	\$9.76 / \$10.64	NA	NA
TT-S-MC-M032-20-X-Z	1.25 / 32	\$8.64 / \$9.60	\$8.92 / \$9.92	\$10.52 / \$11.44	NA	NA
TT-S-MC-M038-24-X-Z	1.50 / 38	\$8.88 / \$9.88	\$9.28 / \$10.32	\$11.68 / \$12.76	\$15.40 / \$19.88	NA
TT-S-MC-M044-28-X-Z	1.75 / 44	\$9.52 / \$10.60	\$10.20 / \$11.04	\$12.44 / \$13.60	\$15.88 / \$20.28	\$18.80 / \$23.24
TT-S-MC-M051-32-X-Z	2.00 / 51	\$10.28 / \$11.44	\$10.80 / \$11.98	\$14.32 / \$15.80	\$16.32 / \$20.60	\$19.24 / \$24.16
TT-S-MC-M063-40-X-Z	2.50 / 63	\$11.72 / \$13.04	\$12.04 / \$13.40	\$16.08 / \$17.80	\$17.24 / \$21.36	\$20.16 / \$25.24
TT-S-MC-M076-48-X-Z	3.00 / 76	\$13.36 / \$14.60	\$13.52 / \$15.04	\$16.60 / \$18.32	\$18.16 / \$22.12	\$21.08 / \$25.96

For the “X” value: specify either A, B, C, D, or E for the bulb size

For the “Z” value: specify “S” for Stainless Steel or “I” for Inconel

**OTHER CUSTOM SIZES AND SHAPES AVAILABLE – PLEASE INQUIRE**

## Silica Tadpole Tape With Rope or Wire Mesh Core 1900°F / 1037°C InSilMax™ XT TadpoleTape™ Extreme High Temperature Heat Flame Resistant



Made from amorphous duty silica fabrics and ropes, this is a soft and resilient gasket material for effective sealing on metal flanges and where limited bolting force is available – and where doors and other closures rest on the bulb of the tape.

Standard Rolls of 50 and 100 feet.

For By-The-Foot pricing: add 25% to price shown:

Produced from an extremely pure base fiber (SiO<sub>2</sub>) and can be used at 1900°F / 1037°C continuously.

InSilMax™ XT TadpoleTape™ Extreme High Temperature; Heat & Flame Resistant With Rope Core						
Part Number	Over All Width in / mm	Price per Foot By Bulb Size: A / B / C / D / E in / mm				
		"A"	"B"	"C"	"D"	"E"
		3/8" / .375 / 7.9	1/2" / .500 / 13	5/8" / .625 / 15.8	3/4" / .750 / 19	1" / 1.00 / 25
TT-SXT-RC-M025-16-X	1.00 / 25	\$ 8.79	\$ 9.11	\$ 11.09	NA	NA
TT-SXT-RC-M032-20-X	1.25 / 32	\$ 9.75	\$ 9.98	\$ 11.91	NA	NA
TT-SXT-RC-M038-24-X	1.50 / 38	\$ 10.03	\$ 10.63	\$ 13.11	\$ 14.31	NA
TT-SXT-RC-M044-28-X	1.75 / 44	\$ 10.72	\$ 11.59	\$ 14.13	\$ 15.05	\$ 18.31
TT-SXT-RC-M051-32-X	2.00 / 51	\$ 11.82	\$ 12.19	\$ 14.67	\$ 15.92	\$ 18.74
TT-SXT-RC-M063-40-X	2.50 / 63	\$ 13.25	\$ 13.75	\$ 15.41	\$ 17.71	\$ 19.40
TT-SXT-RC-M076-48-X	3.00 / 76	\$ 15.13	\$ 15.41	\$ 16.38	\$ 17.81	\$ 21.82

InSilMax™ XT TadpoleTape™ Extreme High Temperature; Heat & Flame Resistant with Stainless Steel or Inconel 600 Mesh Core						
Part Number	Over All Width in / mm	Price per Foot By Bulb Size: A / B / C / D / E in / mm and choice of Stainless Steel / Inconel Bulb				
		"A"	"B"	"C"	"D"	"E"
		3/8" / .375 / 7.9 SS / Inconel	1/2" / .500 / 13 SS / Inconel	5/8" / .625 / 15.8 SS / Inconel	3/4" / .750 / 19 SS / Inconel	1" / 1.000 / 25 SS / Inconel
TT-SXT-MC-M025-16-X-Z	1.00 / 25	\$8.89 / \$9.66	\$9.89 / \$11.04	\$11.22 / \$11.17	NA	NA
TT-SXT-MC-M032-20-X-Z	1.25 / 32	\$9.94 / \$11.04	\$10.26 / \$11.41	\$12.09 / \$13.16	NA	NA
TT-SXT-MC-M038-24-X-Z	1.50 / 38	\$10.21 / \$11.36	\$10.67 / \$11.87	\$13.43 / \$14.67	\$17.71 / \$22.86	NA
TT-SXT-MC-M044-28-X-Z	1.75 / 44	\$10.95 / \$12.19	\$11.73 / \$12.70	\$14.31 / \$15.64	\$18.26 / \$23.32	\$21.62 / \$26.73
TT-SXT-MC-M051-32-X-Z	2.00 / 51	\$11.82 / \$13.16	\$12.42 / \$13.78	\$16.47 / \$18.17	\$18.77 / \$23.69	\$22.13 / \$27.78
TT-SXT-MC-M063-40-X-Z	2.50 / 63	\$13.48 / \$14.99	\$13.85 / \$15.41	\$18.49 / \$20.47	\$19.83 / \$22.43	\$23.18 / \$29.03
TT-SXT-MC-M076-48-X-Z	3.00 / 76	\$15.36 / \$16.79	\$15.55 / \$17.30	\$19.09 / \$21.07	\$20.88 / \$25.43	\$24.24 / \$29.85

For the "X" value: specify either A, B, C, D, or E for the bulb size  
For the "Z" value: specify "S" for Stainless Steel or "I" for Inconel

**OTHER CUSTOM SIZES & SHAPES AVAILABLE – PLEASE INQUIRE**

## Ceramic Fiber Tadpole Tape With Rope or Wire Mesh Core 2000°F / 1093°C CerMax™ TadpoleTape™ Extreme High Temperature Heat Flame Resistant



Made from our highest temperature ceramic fiber inconel wire inserted materials, this is a soft and resilient gasket material for effective sealing on metal flanges and where limited bolting force is available – and where doors and other closures rest on the bulb of the tape.

Standard Rolls of 50 and 100 feet.

For By-The-Foot pricing: add 25% to price shown:

Can be used at 2000°F / 1093°C continuously.

CerMax™ TadpoleTape™ Extreme High Temperature; Heat & Flame Resistant With Rope Core						
Part Number	Over All Width in / mm	Price per Foot By Bulb Size: A / B / C / D / E				
		in / mm				
		"A" 3/8" / .375 / 7.9	"B" 1/2" / .500 / 13	"C" 5/8" / .625 / 15.8	"D" 3/4" / .750 / 19	"E" 1" / 1.000 / 25
TT-C-RC-M038-24-X	1.50 / 38	\$ CALL	\$ CALL	\$ CALL	\$ CALL	NA
TT-C-RC-M044-28-X	1.75 / 44	\$ CALL	\$ CALL	\$ CALL	\$ CALL	\$ CALL
TT-C-RC-M051-32-X	2.00 / 51	\$ CALL	\$ CALL	\$ CALL	\$ CALL	\$ CALL
TT-C-RC-M063-40-X	2.50 / 63	\$ CALL	\$ CALL	\$ CALL	\$ CALL	\$ CALL
TT-C-RC-M076-48-X	3.00 / 76	\$ CALL	\$ CALL	\$ CALL	\$ CALL	\$ CALL

CerMax™ TadpoleTape™ Extreme High Temperature; Heat & Flame Resistant with Inconel 600 Mesh Core						
Part Number	Over All Width in / mm	Price per Foot By Bulb Size: A / B / C / D / E				
		in / mm and Inconel Mesh Bulb				
		"A" 3/8" / .375 / 7.9 SS / Inconel	"B" 1/2" / .500 / 13 SS / Inconel	"C" 5/8" / .625 / 15.8 SS / Inconel	"D" 3/4" / .750 / 19 SS / Inconel	"E" 1" / 1.000 / 25 SS / Inconel
TT-C-MC-M038-24-X	1.50 / 38	\$ CALL	\$ CALL	\$ CALL	\$ CALL	NA
TT-C-MC-M044-28-X	1.75 / 44	\$ CALL	\$ CALL	\$ CALL	\$ CALL	\$ CALL
TT-C-MC-M051-32-X	2.00 / 51	\$ CALL	\$ CALL	\$ CALL	\$ CALL	\$ CALL
TT-C-MC-M063-40-X	2.50 / 63	\$ CALL	\$ CALL	\$ CALL	\$ CALL	\$ CALL
TT-C-MC-M076-48-X	3.00 / 76	\$ CALL	\$ CALL	\$ CALL	\$ CALL	\$ CALL

For the "X" value: specify either A, B, C, D, or E for the bulb size  
For the "Z" value: specify "S" for Stainless Steel or "I" for Inconel

**OTHER CUSTOM SIZES & SHAPES AVAILABLE – PLEASE INQUIRE**

**CerMax Tadpole Tape Technical Data**

CerMax is alumino-silicate based refractory fiber. White and odorless. Available with either a fiberglass or wire re-inforcement. Some organic binder is present, and will smoke-off at elevated temperatures. Once the organics have smoked-off, the product will turn white again. If smoke free operation is required, then it should be heat treated before use.

**Chemical & Physical Data:** Total  $Al_2O_3$  and  $SiO_2$  > 97% ( $Al_2O_3$ : 47%);  $Fe_2O_3$  <1.1%. Weight Loss (1800°F) 8-10%; Refractory Fiber content >85%. Fiber diameter: 2 - 4 microns; Fiber length: 100 - 250 mm. Fiber shrinkage (1800°F, 3 hr) <3.5%

**Thermal Conductivity:** 570°F: 0.84 BTU/ft<sup>2</sup> °F/in (0.12 W/m °K). 1100°F: 0.91 BTU/ft<sup>2</sup> °F/in (0.13 W/m °K). 1800°F: 1.19 BTU/ft<sup>2</sup> °F/in (0.17 W/m °K).



## Fiberglass with PTFE Coating Tadpole Tape: Rope or Wire Mesh Core 550°F / 287°C TadpoleTape™ High Temperature, Heat & Chemical Resistance

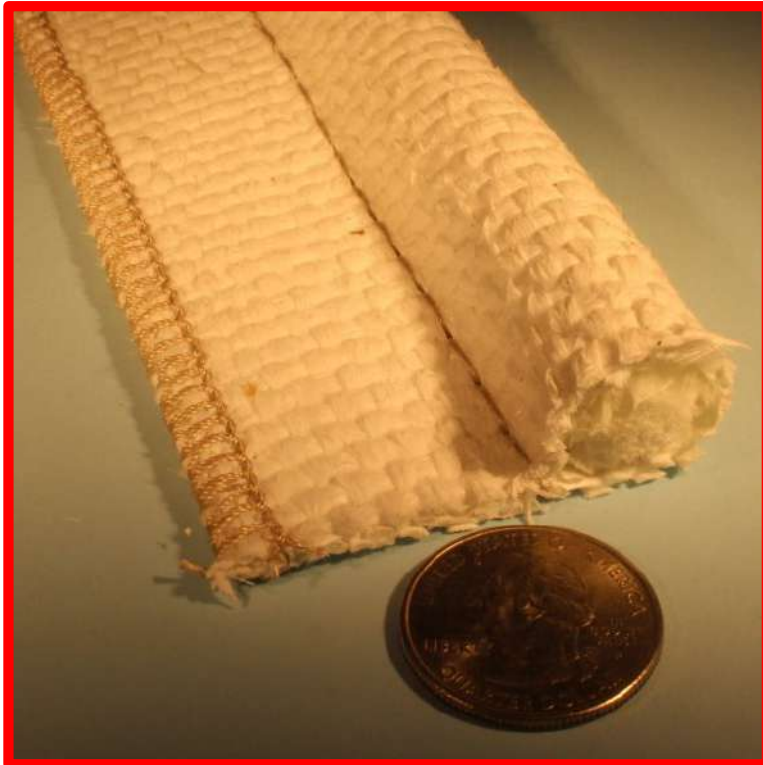

- PTFE Coated Fiberglass

Made from our heavy duty fabrics and ropes/wire mesh; this is a soft and resilient gasket material for effective sealing on light metal flanges and where limited bolting force is available – and where doors and other closures rest on the bulb of the packing.

This fabric offers the advantage of a non-asbestos material with higher temperature range and with excellent resistance to almost all solvents, caustics and acids.

The base fabric is rated to 1000°F / 537°C. PTFE melting point is 620°F / 327°C.

Standard lengths of 50 and 100 feet. For By-The-Foot pricing: add 25% to price shown.

Other Sizes available – please call

The PTFE is applied to the tadpole tape by dipping the tape through an immersion tank of liquid PTFE dispersion. The tape is then heated and air dried as it leaves the dip tank.

The result is a PTFE coating on the tape which is soft, robust and flexible; however, it can be abrasively removed from the tape with aggressive fingernail scraping, resulting in a thinner and thinner layer of ptfе remaining with each pass.

The PTFE also causes the yarns to be sealed and the small gaps between the yarns filled, resulting in an almost air-tight / liquid-tight tape.

## Fiberglass with PTFE Coating Tadpole Tape: Rope or Wire Mesh Core (continued) 550°F / 287°C TadpoleTape™ High Temperature, Heat & Chemical Resistance



Rope Core



Metal Mesh Rope Core

### Tadpole Tape™ High Temperature & Chemical Resistance PTFE Coated Fiberglass with Rope Core

Part Number	Over All Width in / mm	Price per Foot By Bulb Size: A / B / C / D / E in / mm				
		"A"	"B"	"C"	"D"	"E"
		3/8" / .375 / 7.9	1/2" / .500 / 13	5/8" / .625 / 15.8	3/4" / .750 / 19	1" / 1.000 / 25
TT-FG-PT-RC-M025-16-X	1.00 / 25	\$ 6.39	\$ 6.67	\$ 7.49	NA	NA
TT-FG-PT-RC-M032-20-X	1.25 / 32	\$ 6.85	\$ 7.17	\$ 8.42	NA	NA
TT-FG-PT-RC-M038-24-X	1.50 / 38	\$ 7.73	\$ 8.01	\$ 9.25	\$ 9.97	NA
TT-FG-PT-RC-M044-28-X	1.75 / 44	\$ 8.60	\$ 8.87	\$ 10.12	\$ 11.89	\$ 13.48
TT-FG-PT-RC-M051-32-X	2.00 / 51	\$ 9.29	\$ 9.79	\$ 11.22	\$ 12.67	\$ 13.94
TT-FG-PT-RC-M063-40-X	2.50 / 63	\$ 10.53	\$ 10.86	\$ 12.37	\$ 13.78	\$ 14.35
TT-FG-PT-RC-M076-48-X	3.00 / 76	\$ 11.59	\$ 11.92	\$ 12.65	\$ 13.93	\$ 14.99

### TadpoleTape™ High Temperature & Chemical Resistance PTFE Coated Fiberglass: with Stainless Steel or Inconel 600 Mesh Core

Part Number	Over All Width in / mm	Price per Foot By Bulb Size: A / B / C / D / E in / mm and choice of Stainless Steel / Inconel Bulb				
		"A"	"B"	"C"	"D"	"E"
		3/8" / .375 / 7.9 SS / Inconel	1/2" / .500 / 13 SS / Inconel	5/8" / .625 / 15.8 SS / Inconel	3/4" / .750 / 19 SS / Inconel	1" / 1.000 / 25 SS / Inconel
TT-FG-PT-MC-M025-16-X-Z	1.00 / 25	\$10.03 / \$12.67	\$10.49 / \$14.35	\$13.25 / \$16.10	NA	NA
TT-FG-PT-MC-M032-20-X-Z	1.25 / 32	\$10.49 / \$13.43	\$10.95 / \$15.08	\$14.12 / \$16.84	NA	NA
TT-FG-PT-MC-M038-24-X-Z	1.50 / 38	\$11.32 / \$13.80	\$11.77 / \$15.87	\$14.97 / \$17.57	\$18.81 / \$30.18	NA
TT-FG-PT-MC-M044-28-X-Z	1.75 / 44	\$12.23 / \$14.90	\$12.70 / \$16.61	\$15.82 / \$18.67	\$19.69 / \$30.95	\$29.72 / \$36.80
TT-FG-PT-MC-M051-32-X-Z	2.00 / 51	\$12.97 / \$15.68	\$13.52 / \$17.43	\$16.93 / \$20.06	\$20.47 / \$31.78	\$30.26 / \$37.72
TT-FG-PT-MC-M063-40-X-Z	2.50 / 63	\$14.12 / \$17.39	\$14.54 / \$19.09	\$18.08 / \$21.94	\$21.71 / \$33.38	\$30.53 / \$39.19
TT-FG-PT-MC-M076-48-X-Z	3.00 / 76	\$15.18 / \$18.63	\$15.59 / \$20.10	\$19.27 / \$29.39	\$22.68 / \$35.42	\$31.19 / \$41.17

For the "X" value: specify either A, B, C, D, or E  
For the "Z" value: specify "S" for Stainless Steel or "I" for Inconel

Standard lengths of 50 and 100 feet. For By-The-Foot pricing: add 25% to price shown.

## White Rubber Coated Fiberglass Tadpole Tape (Tacky Cloth) with Rope Core

550°F / 287°C: Tuff-Flex™ TadpoleTape™ High Temperature *With or Without Wire Insert*



TadpoleTape™ made from Tuff-Flex™ 550 tacky cloth.

This is a widely used tadpole tape that provides a resilient and non-absorbent gasket material for service against steam, air, water and gases.

Especially useful where a rough or uneven surface or flange exists. The fabric is a fiberglass base with a special white rubber formulation. The fabric is tacky, and has a plastic film surface covering that is removed before installation. The fabric will stick to itself once the film is removed.

**Wire Inserted Version:** The fill (width wise) yarn for this version of the fabric has a twisted brass wire formed with it, providing additional strength and electrical conductivity/shielding.

550°F / 287°C continuous rating, excellent sealing properties as a gasket material

Tuff-Flex™ TadpoleTape™ High Temperature White Rubber Coated Fiberglass Tacky Cloth with Rope Core: with or without wire insert						
Part Number	Over All Width in / mm	Price per Foot By Bulb Size: A / B / C / D / E in / mm				
		"A" 3/8" / .375 / 7.9	"B" 1/2" / .500 / 13	"C" 5/8" / .625 / 15.8	"D" 3/4" / .750 / 19	"E" 1" / 1.000 / 25
TT-FG-TC-M025-16-X-Z	1.00 / 25	\$ 4.80	\$ 5.12	\$ 5.80	NA	NA
TT-FG-TC-M032-20-X-Z	1.25 / 32	\$ 5.00	\$ 5.56	\$ 6.24	NA	NA
TT-FG-TC-M038-24-X-Z	1.50 / 38	\$ 5.48	\$ 5.84	\$ 6.52	\$ 7.48	NA
TT-FG-TC-M044-28-X-Z	1.75 / 44	\$ 6.04	\$ 6.36	\$ 7.04	\$ 8.12	\$ 9.96
TT-FG-TC-M051-32-X-Z	2.00 / 51	\$ 6.60	\$ 6.84	\$ 7.32	\$ 8.84	\$ 11.24
TT-FG-TC-M063-40-X-Z	2.50 / 63	\$ 7.56	\$ 7.84	\$ 8.36	\$ 9.64	\$ 12.84
TT-FG-TC-M076-48-X-Z	3.00 / 76	\$ 8.56	\$ 8.92	\$ 9.40	\$ 10.76	\$ 14.44

For the "X" value in the part number specify either A, B, C, D, or E to correspond to the bulb size

For the "Z" value in the part number use "W" to specify with wire insert use "N" to specify no wire

Same price with and without wire insert

Standard Rolls of 25 and 50 feet. For By-The-Foot pricing: add 25% to price shown.

**OTHER CUSTOM SIZES & SHAPES AVAILABLE – PLEASE INQUIRE**

Curing: It is recommended that this material be cured in situ. This material must be heated to a minimum of 300°F within 60 minutes, then it must sit at 300°F or higher for 90 minutes for the rubber to fully cure.

Do not overtorque the material during this curing time or the rubber will be squeezed off of the base material.

If the material is not fully cured, the rubber will drip from the material causing voids. After curing the material can be exposed to a lower operational temperature.

## Expanded PTFE Tadpole Tape with Rope or Wire Mesh Core 550°F / 287°C TadpoleTape™ High Temperature & Chemical Resistance

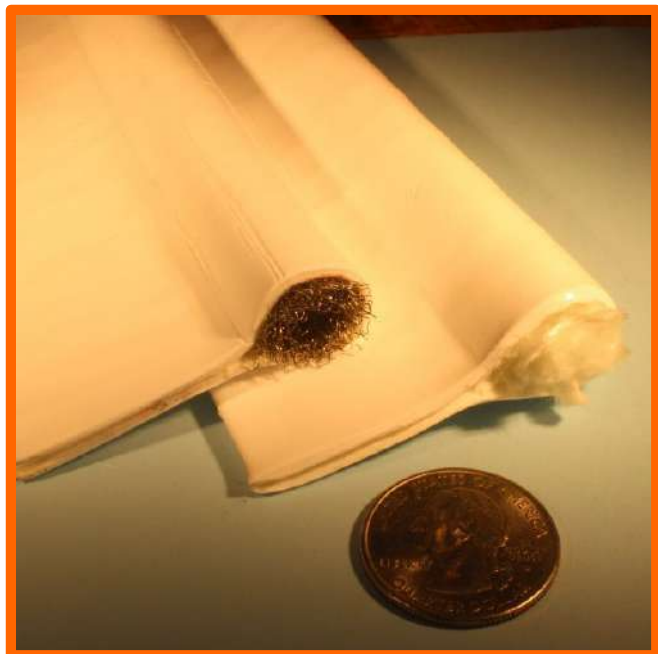

Made from expanded PTFE (ePTFE)

Pure ePTFE tape formed into a tadpole with either a rope core or stainless steel mesh core. Excellent corrosion resistance, high pressure resistance, easy to use.

Excellent resistance to almost all solvents, caustics and acids.

PTFE melting point is 620°F / 327°C.

Standard Roll of 100 feet. Sold in Full Rolls Only

TadpoleTape™ ePTFE with Rope Core						
Part Number	Over All Width in / mm	Price per Roll By Bulb Size: A / B / C / D / E fractional inch / decimal inch / mm				
		"A" 3/8" / .375 / 7.9	"B" 1/2" / .500 / 13	"C" 5/8" / .625 / 16	"D" 3/4" / .750 / 19	"E" 1" / 1.00 / 25
TT-EPT-RC-M025-16-X	1.00 / 25	\$ 915.33	\$ 1147.50	NA	NA	NA
TT-EPT-RC-M032-20-X	1.25 / 32	\$ 1092.67	\$ 1340.00	\$ 1240.33	NA	NA
TT-EPT-RC-M038-24-X	1.50 / 38	\$ 1250.67	\$ 1497.00	\$ 1422.67	\$ 1512.00	NA
TT-EPT-RC-M044-28-X	1.75 / 44	\$ 1352.50	\$ 1672.33	\$ 2040.00	\$ 2153.33	NA
TT-EPT-RC-M051-32-X	2.00 / 51	\$ 1936.67	\$ 2346.67	\$ 2273.33	\$ 2386.67	\$ 2690.00
TT-EPT-RC-M063-40-X	2.50 / 63	\$ 2430.00	\$ 2790.00	\$ 2740.00	\$ 2853.00	\$ 3156.67
TT-EPT-RC-M076-48-X	3.00 / 76	\$ 2990.00	\$ 3233.00	\$ 3206.67	\$ 3320.00	\$ 3623.33

TadpoleTape™ ePTFE with Stainless Steel Mesh Core						
Part Number	Over All Width in / mm	Price per Roll By Bulb Size: A / B / C / D / E fractional inch / decimal inch / mm				
		"A" 3/8" / .375 / 7.9	"B" 1/2" / .500 / 13	"C" 5/8" / .625 / 16	"D" 3/4" / .750 / 19	"E" 1" / 1.00 / 25
TT-EPT-MC-M025-16-X	1.00 / 25	\$ 1376.67	\$ 1456.67	NA	NA	NA
TT-EPT-MC-M032-20-X	1.25 / 32	\$ 1598.00	\$ 1695.00	\$ 1823.33	NA	NA
TT-EPT-MC-M038-24-X	1.50 / 38	\$ 1798.00	\$ 1896.00	\$ 2056.67	\$ 2453.33	NA
TT-EPT-MC-M044-28-X	1.75 / 44	\$ 1930.00	\$ 2123.33	\$ 2290.00	\$ 2686.67	NA
TT-EPT-MC-M051-32-X	2.00 / 51	\$ 2150.00	\$ 2346.67	\$ 2523.33	\$ 2920.00	\$ 3306.67
TT-EPT-MC-M063-40-X	2.50 / 63	\$ 2643.33	\$ 2790.00	\$ 2990.00	\$ 3386.67	\$ 3773.33
TT-EPT-MC-M076-48-X	3.00 / 76	\$ 3203.33	\$ 3233.33	\$ 3456.67	\$ 3853.33	\$ 4240.00

For the "X" value: specify either A, B, C, D, or E for the bulb size

**OTHER SIZES AVAILABLE – PLEASE INQUIRE**

## **TTWearGuard**

Most Tadpole Tapes can be wrapped in a stainless steel mesh to offer high degree of abrasion resistance.

Please enquire on pricing.



## **Custom Size and Custom Construction TadpoleTape™**

**Our fabrication shop can produce almost any size and shape gasket, tadpole shape or almost any other shape.**

**Some of the common shapes include double bulb, square bulb, and metal mesh covered.**

**To assist our fabrication shop, any sketch, drawing, or photo of an existing item would be useful.**

**Please contact us to obtain a price and time quotation.**

# Lacing Tape

NyLace™ Nylon Lacing Tape .....	2-135
PolyLace™ Polyester Dacron Lacing Tape .....	2-136
PtLace™ PTFE Lacing Tape .....	2-137
GlasLace™ Fiberglass Lacing Tape .....	2-138
NMXLace™ Nomex Lacing Tape .....	2-139



## Nylon® Lacing Tape A-A-52080 Type I / MIL-T-43435

Heat Resistant High Strength Lacing Tape

- Natural, Wax or Synthetic Rubber Finish

-67°F to 250°F - Melting Point 478°F



- General purpose lacing tape.
- Color: Natural or Black
- Good abrasion resistance and tensile strength.



### Nylon® Lacing Tape - A-A-52080 Type I / MIL-T-43435

-67°F to 250°F

Part Number	Mil Spec Size	Width		Thickness		Spool Length feet	Price Finish A / B / C
		Min / Max inches	Min / Max inches	Min / Max inches	Min / Max inches		
T-LACE-NY-1-X-Y	1	0.180	0.220	0.013	0.019	750	\$ 33.63 / 55.00 / 40.50
T-LACE-NY-2-X-Y	2	0.099	0.121	0.012	0.018	750	\$ 22.75 / 37.50 / 25.80
T-LACE-NY-3-X-Y	3	0.077	0.094	0.011	0.017	1500	\$ 22.50 / 38.75 / 26.93
T-LACE-NY-4-X-Y	4	0.054	0.066	0.009	0.015	1500	\$ 19.38 / 33.75 / 27.75
T-LACE-NY-5-X-Y	5	0.045	0.055	0.006	0.014	1500	\$ 16.25 / 23.37 / 19.50

**Above Pricing is for Natural – For Black add 30%**

For the “X” value in the part number specify either:

“A” for Natural, “B” for Wax, or “C” for Synthetic Rubber finish

For the “Y” value in the part number: use “N” for Natural

use “B” to specify Black

\$100.00 Minimum Order

**Polyester Dacron® Lacing Tape A-A-52081 Type II / MIL-T-43435**  
Heat Resistant High Strength Lacing Tape  
- Natural, Wax or Synthetic Rubber Finish  
-99°F to 350°F - Melting Point 482°F

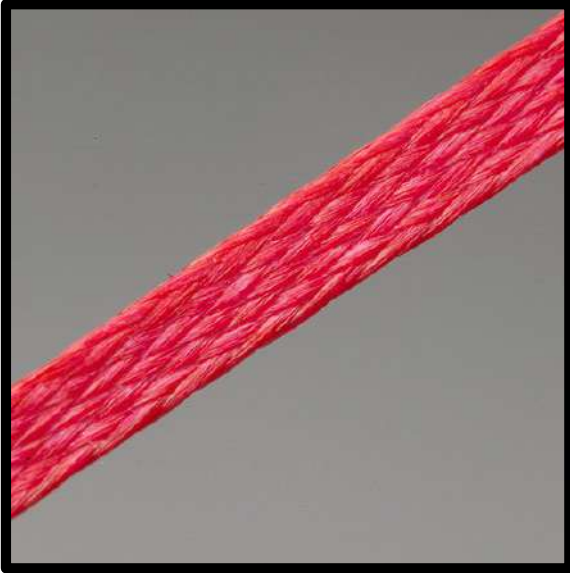

- General purpose lacing tape, superior knot tying and holding compared to Nylon.
- Suitable for Aviation / Aerospace applications
- Color: Finish A / Natural or Black  
Finish B & C / Natural, Black or Red
- Good abrasion resistance and tensile strength.



Polyester Dacron Lacing Tape - A-A-52081 Type II / MIL-T-43435 -99°F to 350°F							
Part Number	Mil Spec Size	Width		Thickness		Spool Length feet	Price Finish A / B / C
		Min / Max inches		Min / Max inches			
T-LACE-DA-1-X-Y	1	0.180	0.220	0.013	0.019	750	\$ 30.87 / 57.50 / 35.10
T-LACE-DA-2-X-Y	2	0.099	0.121	0.012	0.018	750	\$ 27.37 / 32.50 / 31.25
T-LACE-DA-3-X-Y	3	0.077	0.094	0.011	0.017	1500	\$ 20.62 / 36.50 / 25.00
T-LACE-DA-4-X-Y	4	0.054	0.066	0.009	0.015	1500	\$ 17.25 / 30.87 / 20.25
T-LACE-DA-5-X-Y	5	0.045	0.055	0.006	0.014	1500	\$ 16.87 / 28.12 / 18.12

**Above Pricing is for Natural – For Black or Red add 15%**

**For the “X” value in the part number specify either:  
“A” for Natural, “B” for Wax, or “C” for Synthetic Rubber finish**

**For the “Y” value in the part number: use “N” for Natural  
use “B” for Black  
use “R” for Red**

\$100.00 Minimum Order

**PTFE Fluorocarbon (Teflon®) Lacing Tape A-A-52082 Type III / MIL-T-43435**

**Heat & Chemical Resistant Lacing Tape**  
 - No Finish  
 -99°F to 450°F - Melting Point 620°F

- Suitable for aircraft engine applications.
- Natural (Brown/Tan Color)



PTFE Fluorocarbon (Teflon) Lacing Tape - A-A-52082 Type III / MIL-T-43435							
-99°F to 450°F							
Part Number	Mil Spec Size	Width		Thickness		Spool Length feet	Price
		Min / Max inches	Min / Max inches	Min / Max inches	Min / Max inches		
T-LACE-PT-2	2	0.108	0.132	0.009	0.014	750	\$ 123.50
T-LACE-PT-4	4	0.059	0.072	0.009	0.014	1500	\$ 109.50



**Fiberglass (E-grade) Lacing Tape A-A-52083 Type IV / MIL-T-43435**  
Heat & Very High Temperature Resistant Non Flammable Lacing Tape  
- Natural with PTFE finish  
-67°F to 900°F - Melting Point 2100°F



- Very high temperature applications.
- Low elongation. Not affected by moisture.
- Color: Natural



**Fiberglass Lacing Tape - A-A-52083 Type IV / MIL-T-43435**  
**-67°F to 900°F**

Part Number	Mil Spec Size	Width		Thickness		Spool Length feet	Price
		Min / Max inches		Min / Max inches			
T-LACE-FG-1	1	0.203	0.248	0.013	0.019	750	\$ 123.00
T-LACE-FG-2	2	0.099	0.121	0.013	0.019	750	\$ 99.00
T-LACE-FG-3	3	0.077	0.094	0.013	0.019	1500	\$ 143.50
T-LACE-FG-4	4	0.054	0.066	0.013	0.019	1500	\$ 105.00

**Nomex® Meta Aramid Lacing Tape A-A-52084 Type V / MIL-T-43435**  
**Heat & Very High Temperature Resistant Non Flammable Lacing Tape**  
 - Natural or Synthetic Rubber finish  
 -67°F to 500°F - Melting Point 700°F



- Very high temperature applications.
- Non-flammable.
- Suitable for aircraft wiring applications.
- Color: Natural



Nomex® Meta-Aramid Lacing Tape - A-A-52084 Type V / MIL-T-43435							
-67°F to 500°F							
Part Number	Mil Spec Size	Width		Thickness		Spool Length feet	Price A or C
		Min / Max inches	Min / Max inches	Min / Max inches	Min / Max inches		
T-LACE-NMX-1-X	1	0.180	0.220	0.013	0.019	750	\$ 288.00
T-LACE-NMX-2-X	2	0.099	0.121	0.011	0.017	750	\$ 153.00
T-LACE-NMX-3-X	3	0.068	0.083	0.009	0.015	1500	\$ 162.50
T-LACE-NMX-4-X	4	0.050	0.061	0.007	0.013	1500	\$ 134.00

For the “X” value in the part number specify either:  
 “A” for Natural or “C” for Synthetic Rubber finish



**Thermal, EMI/RFI & Abrasion Protection Materials**

Fax Orders: 610-340-9054 Telephone Orders: 610-906-3549 [orders@abthermal.com](mailto:orders@abthermal.com)

---



**High Temperature, Heat, Flame, Fire, Molten Metal & Weld Splatter Protection Materials**

*Fax Orders: 610-340-9054 Telephone Orders: 610-906-3549 orders@abthermal.com*

---

---



# Rope & Packing

Kevlar Aramid Rope .....	3-1
Solid Silicone Rubber Cord/Rope .....	3-2
Silicone Sponge Cord .....	3-3
Silicone Rubber Coated Fiberglass Rope .....	3-4
Acrylic Fiber with PTFE Impregnation Rope / Packing .....	3-6
Pure PTFE Square Braid Rope / Packing .....	3-7
Fiberglass with soft PTFE Coating Gasket Rope: Round Soft / Round Dense / Twisted / Square .....	3-7
PTFE Square Rope / Packing with Graphite Coating .....	3-12
Fiberglass: Knitted Round Soft / Knitted Round Dense / Round Twisted / Square Braided .....	3-13
Fiberglass Rope with Kevlar® Overbraid .....	3-21
Fiberglass Compression Gasket Rope: Oven, Stove & Dryer – Hollow Metal Core - Clip Mounting .....	3-22
Fiberglass Knitted Rope with Stainless Mesh Core - Industrial Grade .....	3-24
Heat Treated Fiberglass Braided Rope with Stainless Mesh Core - Premium Grade - Clean Room & Paint Shop Door Gasket Suitable .....	3-25
Fiberglass Gasket & Seal Ropes with Stainless Steel Wire Jacket - Custom Sized .....	3-26
Fiberglass Kiln & Oven Door Gasket Seal Rope with Twin Stainless Steel Wire Rope Cores and Stainless Steel Wire Jacket: 1.5" x 2" .....	3-27
Stainless Core with Fiberglass Overbraid & Stainless Outer Overbraid Turbine Exhaust Gasket Seal .....	3-28
Fiberglass with Graphite Impregnation Rope: Round Soft / Round Dense / Square .....	3-29
Pure Graphite Rope / Packing - Square Braided / With Wire / With Carbon Edges .....	3-32
Fiberglass with Vermiculite Coating Rope: Soft / Dense / Twisted / Square .....	3-34
Silica Knitted Cord / Rope - Small Size .....	3-38
Silica Rope: Knit / Twisted / Square .....	3-39



**Thermal, EMI/RFI & Abrasion Resistant Materials**

Fax Orders: 610-340-9054 Telephone Orders: 610-906-3549 [orders@abthermal.com](mailto:orders@abthermal.com)

---

Ceramic Fiber Rope: Premium & Industrial Grade - Braided Knit / Twisted / Square ..... 3-42

Stainless Steel / Inconel Mesh Rope ..... 3-47

Wire, Cable, Harness and Hose Overbraid Service ..... 3-48



**Thermal, EMI/RFI & Abrasion Resistant Materials**

Fax Orders: 610-340-9054 Telephone Orders: 610-906-3549 [orders@abthermal.com](mailto:orders@abthermal.com)

---



**Kevlar® 12-Strand Single Braid Rope**  
**320°F / 160°C: Continuous Rating – Higher Temperature for Shorter Periods**  
**FlameShield™ High Temperature, Heat Resistant High Strength & Cut Resistant**



- 100% Kevlar rope. 12-Strand single braid.
- Fibers are 20 times stronger than steel for the same diameter.
- Highly cut resistant.
- Low stretch, high strength.
- Available in natural (yellow) color.
- Not recommended for use over pulleys or repetitive flexing applications.
- Specific gravity 1.44; Elongation at break 1.5-4.5%

**320°F / 160°C maximum continuous rating. Short term exposure to 572°F / 300°C**

<b>FlameShield™ High Temperature &amp; Heat Resistant 12-Strand Single Braided Kevlar® Rope - Premium</b>					
<b>Part Number</b>	<b>Nominal OD</b>	<b>Circumference in / mm</b>	<b>Average Tensile Lb / kg</b>	<b>Price per Spool / Wt (lbs)</b>	<b>Price per Foot</b>
R-K-M006-02-X	1/8" / 3.1 mm	3/8" / 9.7	1,500 / 682	\$ 682.16 / 4	\$ 2.27
R-K-M006-03-X	3/16" / 4.7 mm	9/16" / 14.7	3,600 / 1636	\$ 1030.60 / 7	\$ 3.43
R-K-M006-04-X	1/4" / 6.2 mm	3/4" / 19.5	6,600 / 3000	\$ 1442.01 / 12	\$ 4.81
R-K-M006-05-X	5/16" / 7.9 mm	1" / 24.8	9,500 / 4318	\$2132.88 / 18	\$ 7.11
R-K-M006-06-X	3/8" / 9.5 mm	1 1/8" / 29.8	12,000 / 5454	\$ 2863.00 / 24	\$ 9.54
R-K-M006-07-X	7/16" / 11.1 mm	1 1/4" / 34.8	15,000 / 6818	\$ 3391.40 / 30	\$ 11.30
R-K-M013-08-X	1/2" / 12.7 mm	1 1/2" / 39.8	22,000 / 10000	\$ 4931.76 / 47	\$ 16.44
R-K-M013-10-X	5/8" / 15.8 mm	2" / 49.6	36,000 / 16363	\$ 8669.68 / 84	\$ 28.90
R-K-M019-12-X	3/4" / 19.0 mm	9/16" / 59.6	49,000 / 22272	\$ 11559.76 / 116	\$ 38.53
R-K-M019-14-X	7/8" / 22.2 mm	2 3/4" / 69.7	60,000 / 27272	\$ 13811.32 / 142	\$ 46.04
R-K-M025-25-X	1" / 25.4 mm	3" / 79.7	78,000 / 35454	\$ 17409.00 / 184	\$ 58.03

**For the "X" value: "F" for By-The-Foot followed by length in feet (example: F66 = 66 feet)  
use "S" for Spool**

**This Product is available By-The-Foot and in Spools. Spools are 600 feet.**

**Kevlar® Aramid Fiber Shears / Cutters: (See complete list at the end of Section 7)**

Kevlar® and aramid based products are difficult to cut due to their filament shear strength. Heavy duty scissors can sometimes cut these materials, but often fail quickly as the Kevlar quickly dulls the cutting edge. Kevlar® Shears are specifically designed to cut Kevlar® and aramid products, and feature a serrated blade so that the fibers don't slip while cutting, holding the fiber in position and allowing for a greater shear force to be applied by the opposing blade. These shears are Extra Heavy Duty, and can be used for other materials such as cutting steel wires and steel tie wraps.

**TL-S-KEV-HD-3725 10" length, 4.9" cutting length, Single serrated blade: \$52.00**  
**TL-S-KEV-HD-3925 10" length, 4.9" cutting length, Double serrated blade: \$54.00**



## Silicone Rubber Cord / Rope - High Temperature & Heat Resistant 400°F / 204°C



- Suitable for continuous operation from -80°F (-62°C) to 400°F (204°C).
- Depending on media and application useful life at temperatures up to 570°F (300°C) may be obtained.
- Stock in 60ShA hardness in red.

Durometer:	60
Tensile Strength, psi (Mpa):	1500 (10.3)
Tear Strength, pli (N/mm):	120 (21)
Elongation, %:	470
Specific gravity:	1.15
Dielectric Strength, V/mil (kV/mm):	584 (23)
Brittle point, F/C:	-112 (-80)
Compression Set, 22 hrs / 347°F/175°C. %:	35

### FlameShield™ High Temperature, Heat & Flame Resistant Silicone Rubber Cord / Rope

Size: .070" to 0.562" (1.8mm to 14.3mm)

Part Number	Diameter in / mm	Coil Length ft / m	Price per Spool
R-SR-070-M0018	.070 / 1.78	100 / 30.48	\$ 92.90
R-SR-090-M0022	.090 / 2.28	100 / 30.48	\$ 94.21
R-SR-093-M0024	.093 / 2.36	100 / 30.48	\$ 96.73
R-SR-103-M0026	.103 / 2.62	100 / 30.48	\$ 104.21
R-SR-109-M0027	.109 / 2.76	100 / 30.48	\$ 108.68
R-SR-125-M0032	.125 / 3.18	100 / 30.48	\$ 111.27
R-SR-139-M0035	.139 / 3.53	100 / 30.48	\$ 118.90
R-SR-156-M0040	.156 / 3.96	100 / 30.48	\$ 122.73
R-SR-187-M0048	.187 / 4.75	100 / 30.48	\$ 144.88
R-SR-210-M0053	.210 / 5.33	100 / 30.48	\$ 152.22
R-SR-250-M0064	.250 / 6.35	100 / 30.48	\$ 163.26
R-SR-275-M0070	.275 / 6.99	100 / 30.48	\$ 189.26
R-SR-312-M0080	.312 / 7.92	100 / 30.48	\$ 204.26
R-SR-375-M0095	.375 / 8.89	100 / 30.48	\$ 267.26
R-SR-437-M0110	.437 / 11.01	100 / 30.48	\$ 359.66
R-SR-500-M0127	.500 / 12.70	100 / 30.48	\$ 391.65
R-SR-562-M0142	.562 / 14.27	100 / 30.48	\$ 417.31

Other sizes available by quotation

## Silicone Sponge Cord - High Temperature & Heat Resistant 392°F / 200°C



- Suitable for continuous operation from -80°F (-62°C) to 392°F (200°C).
- Depending on media and application useful life at temperatures up to 425°F (218°C) may be obtained.
- Density 16lb per cubic foot
- Compression recovery; 25% deflection: 100% at room temperature. Slightly reduced at elevated temperatures
- Thermal value: 0.0695 W(M.K)
- Tensile strength 65 Newtons

### FlameShield™ High Temperature, Heat & Flame Resistant Silicone Sponge Cord

Size: .062" to 1.000" (1.8mm to 14.3mm)

Part Number	Diameter in / mm	Spool Length ft / m	Color	Price per Spool
R-SSC-M0016	.062 / 1.57	50 / 15.24	Blue	\$ 49.50
R-SSC-M0031	.125 / 3.17	50 / 15.24	Black	\$ 57.12
R-SSC-M0047	.187 / 4.74	50 / 15.24	Red	\$ 63.33
R-SSC-M0055	.218 / 5.53	50 / 15.24	Red	\$ 94.48
R-SSC-M0063	.250 / 6.35	50 / 15.24	Grey	\$ 97.37
R-SSC-M0079	.312 / 7.92	50 / 15.24	Blue	\$ 112.54
R-SSC-M0095	.375 / 9.52	50 / 15.24	Red	\$ 183.21
R-SSC-M0110	.437 / 11.09	50 / 15.24	Grey	\$ 216.87
R-SSC-M0127	.500 / 12.70	25 / 7.62	Orange	\$ 135.68
R-SSC-M0158	.625 / 15.87	25 / 7.62	Grey	\$ 180.53
R-SSC-M0190	.750 / 19.05	25 / 7.62	Red	\$ 258.93
R-SSC-M0222	.875 / 22.22	25 / 7.62	Grey	\$ 327.54
R-SSC-M0254	1.000 / 25.40	25 / 7.62	Blue	\$ 394.68

**Silicone Rubber Coated Fiberglass Rope**  
**500°F / 260°C Continuous Rating – Higher Temperature for Shorter Periods**  
**High Temperature, Heat & Flame Resistant**  
**Gasket Rope for Liquid / Gas / Steam Containment**



FlameShield™ FG-SR rope is an excellent gasket rope for high temperature sealing, especially for liquid or gas containment, steam, etc.

Also an excellent cold temperature rope with flexibility to -76°C for refrigeration and cryogenic applications.

The leftmost rope in the above photo shows a partial coat rope. The 3 ropes on the right are full coat. The uncoated area of the partial coat rope can be used for adhesively or mechanically fastening the rope to metalwork.

Our liquid and paste silicone rubber sealants can be used to seal the joint area for continuous ring gasket applications.

**Silicone Rubber Coated Fiberglass Rope**  
**500°F / 260°C Continuous Rating – Higher Temperature for Shorter Periods**  
 (Continued)



500°F / 260°C continuous rating with higher intermittent capability  
 Weld splatter & molten metal splash protection.

**FlameShield™ High Temperature Silicone Rubber Coated  
 Fiberglass Rope; Full Coating & Partial Coating**

Part Number	Nominal ID Inches / mm / Dash #			Partial Coat Coil Length ft	Price per coil Partial Coat	Price per 100 ft coil Full Coat	Price per Foot Full Coat	Price per Metre Full Coat
R-FG-SR-M006-04-X-Y	1/4	6	-4	2500	\$ 7325.00	\$ 217.00	\$ 3.97	\$ 13.03
R-FG-SR-M008-05-X-Y	5/16	8	-5	2000	\$ 6900.00	\$ 245.00	\$ 4.47	\$ 14.66
R-FG-SR-M010-06-X-Y	3/8	10	-6	1500	\$ 7155.00	\$ 337.00	\$ 6.17	\$ 20.24
R-FG-SR-M013-08-X-Y	1/2	13	-8	750	\$ 5077.50	\$ 447.00	\$ 8.94	\$ 29.33
R-FG-SR-M016-10-X-Y	5/8	16	-10	500	\$ 4200.00	\$ 550.00	\$ 11.00	\$ 36.09
R-FG-SR-M019-12-X-Y	3/4	19	-12	N/A		\$ 582.00	\$ 11.64	\$ 38.18
R-FG-SR-M022-14-X-Y	7/8	22	-14	N/A		\$ 711.00	\$ 14.22	\$ 46.64
R-FG-SR-M025-16-X-Y	1	25	-16	N/A		\$ 820.00	\$ 16.40	\$ 53.79
R-FG-SR-M032-20-X-Y	1 1/4	32	-20	N/A		\$ 1125.00	\$ 22.50	\$ 73.80

For the "X" value; Replace with "FC" for Full Coating, and "PC" for Partial Coating

For the "Y" value; Replace with "100" for full coil, and "ZZ" for by the foot,  
 where ZZ = length in feet

**Standard coil length for full coating rope is 100 feet / 30 Metres.**  
**Partial Coat rope only available in full coil length.**

## Acrylic Fiber with PTFE Impregnation Square Braided Gasket & Compression Packing Rope 500°F / 260°C: High Temperature Heat & Chemical Resistance



- Economical alternative to Asbestos
- Acrylic synthetic fiber with PTFE Impregnation
- pH: 2 to 12
- Up to 3000 psi
- Shaft speed up to 2500 feet per minute

This rope offers the advantage of a non-asbestos material with higher temperature range and with excellent resistance to almost all solvents, caustics and acids.

Used as a pump packing and stuffing box packing

High Temperature & Chemical Resistance Acrylic Fiber with PTFE Impregnation Square Braid Rope / Packing				
Part Number	OD Size inch / mm	Feet per Spool	Feet per Pound	Price per Pound
R-A-PT-SQ-M003-02	0.125 / 3	500	100	\$ 35.75
R-A-PT-SQ-M005-03	0.187 / 5	225	45	\$ 35.75
R-A-PT-SQ-M006-04	0.250 / 6	100	25	\$ 35.75
R-A-PT-SQ-M008-05	0.312 / 8	85	17	\$ 35.75
R-A-PT-SQ-M010-06	0.375 / 10	60	12	\$ 35.75
R-A-PT-SQ-M011-07	0.437 / 11	45	9	\$ 35.75
R-A-PT-SQ-M013-08	0.500 / 13	35	7	\$ 35.75
R-A-PT-SQ-M014-09	0.562 / 14	55	5.5	\$ 35.75
R-A-PT-SQ-M016-10	0.625 / 16	45	4.5	\$ 35.75
R-A-PT-SQ-M019-12	0.750 / 19	31	3.1	\$ 35.75
R-A-PT-SQ-M022-14	0.875 / 22	23	2.3	\$ 35.75

This product is sold in a minimum 5 pound spool, and additionally in 1 pound increments



## Pure PTFE Square Braided Gasket & Compression Packing Seal Rope 550°F / 287°C: High Temperature Heat & Chemical Resistance



- Pure PTFE
- pH: 0 to 14
- Up to 2500 psi
- Shaft speed up to 1600 feet per minute
- Use in corrosive and “clean” applications

This pure PTFE square rope offers the advantage of a non-asbestos material with high temperature range and with excellent resistance to almost all solvents, caustics and acids.

PTFE melting point is 620°F / 327°C.

Used as a pump packing and stuffing box packing

Pure PTFE Square Braid Rope / Packing High Temperature & Chemical Resistance				
Part Number	OD Size inch / mm	Feet per Spool	Feet per Pound	Price per Pound
R-PTFE-SQ-M003-02	0.125 / 3	415	83	\$ 58.44
R-PTFE-SQ-M005-03	0.187 / 5	180	36	\$ 58.44
R-PTFE-SQ-M006-04	0.250 / 6	102	20.4	\$ 58.44
R-PTFE-SQ-M008-05	0.312 / 8	68	13.6	\$ 58.44
R-PTFE-SQ-M010-06	0.375 / 10	46	9.3	\$ 58.44
R-PTFE-SQ-M011-07	0.437 / 11	34	6.9	\$ 58.44
R-PTFE-SQ-M013-08	0.500 / 13	26	5.3	\$ 58.44
R-PTFE-SQ-M014-09	0.562 / 14	42	4.2	\$ 58.44
R-PTFE-SQ-M016-10	0.625 / 16	35	3.5	\$ 58.44
R-PTFE-SQ-M019-12	0.750 / 19	23	2.36	\$ 58.44
R-PTFE-SQ-M022-14	0.875 / 22	17	1.76	\$ 58.44

**THIS PRODUCT IS SOLD IN ONE POUND INCREMENTS**

## Knitted Fiberglass Rope with PTFE Coating - High Temperature Heat & Chemical Resistance

550°F / 287°C: *Round Soft Rope*



- PTFE sintered impregnation

This rope offers the advantage of a non-asbestos material with high temperature range and with excellent resistance to almost all solvents, caustics and acids.

The base yarn is rated to 1200°F / 648°C.

PTFE melting point is 620°F / 327°C.

Used as a pump packing and stuffing box packing

High Temperature & Chemical Resistance Knitted Fiberglass Rope with PTFE Coating: <i>Round Soft Rope</i>			
Part Number	OD Size inch / mm	Feet per Spool	Price per foot / meter
R-FG-PT-KS-M002-01	0.062 / 1.6	2,500	\$ 1.20 / \$ 3.94
R-FG-PT-KS-M003-02	0.125 / 3	1,500	\$ 1.23 / \$ 4.04
R-FG-PT-KS-M005-03	0.187 / 5	2,100	\$ 1.25 / \$ 4.10
R-FG-PT-KS-M006-04	0.250 / 6	1,300	\$ 1.27 / \$ 4.17
R-FG-PT-KS-M010-06	0.375 / 10	750	\$ 1.36 / \$ 4.46
R-FG-PT-KS-M013-08	0.500 / 13	500	\$ 2.56 / \$ 8.40
R-FG-PT-KS-M016-10	0.625 / 16	300	\$ 2.98 / \$ 9.78
R-FG-PT-KS-M019-12	0.750 / 19	200	\$ 4.72 / \$ 15.49
R-FG-PT-KS-M022-14	0.875 / 22	150	\$ 5.28 / \$ 17.32
R-FG-PT-KS-M025-16	1.000 / 25	125	\$ 8.44 / \$ 27.69
R-FG-PT-KS-M032-20*	1.250 / 32	85	\$ 8.63 / \$ 28.31
R-FG-PT-KS-M038-24*	1.500 / 38	55	\$ 10.57 / \$ 34.68

**This Product is Available By-The-Foot Except Where Indicated**

\*These items are sold in full length spools only.

The PTFE is applied to the rope by a proprietary sinterization process. The rope is soaked repeatedly in a PTFE dispersion, dried, and then baked. The result is a PTFE coating on the rope which is soft, robust and flexible; however, it can be abrasively removed from the rope with aggressive fingernail scraping, resulting in a thinner and thinner layer of ptfе remaining with each pass. The PTFE also causes the yarns to be sealed and the small gaps between the yarns filled, resulting in an almost air-tight / liquid-tight rope.

## Fiberglass Knitted Round Rope with PTFE Coating

### 550°F / 287°C: High Temperature Heat & Chemical Resistance Knitted Round Dense Rope



- PTFE Impregnation

This rope offers the advantage of a non-asbestos material with higher temperature range and with excellent resistance to almost all solvents, caustics and acids.

The base yarn is rated to 1200°F / 648°C.

PTFE melting point is 620°F / 327°C.

550°F / 287°C continuous rating, high insulation value

Used as a pump packing and stuffing box packing

#### Very High Temperature Knitted Fiberglass Rope with PTFE Coating: *Round Dense Rope*

Part Number	OD Size inch / mm	Feet per Spool	Price per foot
R-FG-PT-KD-M003-02	0.125 / 3	1,500	\$ 0.84
R-FG-PT-KD-M005-03	0.187 / 5	1,750	\$ 0.96
R-FG-PT-KD-M006-04	0.250 / 6	1,100	\$ 1.08
R-FG-PT-KD-M010-06	0.375 / 10	600	\$ 1.52
R-FG-PT-KD-M013-08	0.500 / 13	400	\$ 2.88
R-FG-PT-KD-M016-10	0.625 / 16	260	\$ 3.32
R-FG-PT-KD-M019-12	0.750 / 19	160	\$ 5.24
R-FG-PT-KD-M022-14	0.875 / 22	120	\$ 5.92
R-FG-PT-KD-M025-16	1.000 / 25	100	\$ 9.36
<i>R-FG-PT-KD-M032-20*</i>	1.250 / 32	70	\$ 9.60
<i>R-FG-PT-KD-M038-24*</i>	1.500 / 38	55	\$ 11.70
<i>R-FG-PT-KD-M051-32*</i>	2.000 / 51	50	\$ 48.77
<i>R-FG-PT-KD-M064-40*</i>	2.500 / 64	100	\$ 66.76
<i>R-FG-PT-KD-M076-48*</i>	3.000 / 76	100	\$ 84.30
<i>R-FG-PT-KD-M102-64*</i>	4.000 / 102	100	\$ 175.37

**This Product is Available By-The-Foot Except Where Indicated**

\*These items are sold in full length spools only.

The PTFE is applied to the rope by a proprietary sinterization process. The rope is soaked repeatedly in a PTFE dispersion, dried, and then baked. The result is a PTFE coating on the rope which is soft, robust and flexible; however, it can be abrasively removed from the rope with aggressive fingernail scraping, resulting in a thinner and thinner layer of ptfе remaining with each pass. The PTFE also causes the yarns to be sealed and the small gaps between the yarns filled, resulting in an almost air-tight / liquid-tight rope.

## Round Twisted Fiberglass Rope with PTFE Coating 550°F / 287°C: High Temperature Heat & Chemical Resistance



- PTFE Impregnation

This rope offers the advantage of a non-asbestos material with higher temperature range and with excellent resistance to almost all solvents, caustics and acids.

The base yarn is rated to 1200°F / 648°C.

PTFE melting point is 620°F / 327°C.

Used as a pump packing and stuffing box packing

High Temperature Heat & Chemical Resistance Fiberglass Round Twisted Rope with PTFE Coating			
Part Number	OD Size inch / mm	Feet per Spool	Price per foot
R-FG-PT-T-M003-02	0.125 / 3	2,525	\$ 0.99
R-FG-PT-T-M006-04	0.250 / 6	1,275	\$ 1.36
R-FG-PT-T-M010-06	0.375 / 10	969	\$ 2.56
R-FG-PT-T-M013-08	0.500 / 13	523	\$ 3.24
R-FG-PT-T-M016-10	0.625 / 16	305	\$ 5.20
R-FG-PT-T-M019-12	0.750 / 19	168	\$ 9.52
R-FG-PT-T-M022-14	0.875 / 22	144	\$ 11.04
R-FG-PT-T-M025-16	1.000 / 25	114	\$ 13.92
R-FG-PT-T-M032-20*	1.250 / 32	77	\$ 18.43
R-FG-PT-T-M038-24*	1.500 / 38	50	\$ 36.67
R-FG-PT-T-M051-28*	2.000 / 51	27	\$ 78.60

**This Product is Available By-The-Foot Except Where Indicated**

\*These items are sold in full length spools only.

The PTFE is applied to the rope by a proprietary sinterization process. The rope is soaked repeatedly in a PTFE dispersion, dried, and then baked. The result is a PTFE coating on the rope which is soft, robust and flexible; however, it can be abrasively removed from the rope with aggressive fingernail scraping, resulting in a thinner and thinner layer of ptfе remaining with each pass. The PTFE also causes the yarns to be sealed and the small gaps between the yarns filled, resulting in an almost air-tight / liquid-tight rope.

## Square Braided Fiberglass Rope / Packing with PTFE Impregnation 550°F / 287°C: High Temperature Heat & Chemical Resistance



- PTFE Impregnation

This rope offers the advantage of a non-asbestos material with higher temperature range and with excellent resistance to almost all solvents, caustics and acids.

The base yarn is rated to 1200°F / 648°C.

PTFE melting point is 620°F / 327°C.

Used as a pump packing and stuffing box packing

High Temperature & Chemical Resistance Fiberglass Square Braided Rope with PTFE Coating			
Part Number	OD Size inch / mm	Feet per Spool	Price per foot
R-FG-PT-SQ-M006-04	0.250 / 6	375	\$ 5.60
R-FG-PT-SQ-M008-05	0.312 / 8	315	\$ 4.90
R-FG-PT-SQ-M010-06	0.375 / 10	285	\$ 5.07
R-FG-PT-SQ-M011-07	0.437 / 11	212	\$ 6.80
R-FG-PT-SQ-M013-08	0.500 / 13	162	\$ 8.90
R-FG-PT-SQ-M014-09	0.562 / 14	127	\$ 11.33
R-FG-PT-SQ-M016-10	0.625 / 16	105	\$ 13.70
R-FG-PT-SQ-M019-12	0.750 / 19	75	\$ 19.20
R-FG-PT-SQ-M022-14	0.875 / 22	55	\$ 26.17
R-FG-PT-SQ-M025-16	1.000 / 25	45	\$ 31.98
R-FG-PT-SQ-M032-20*	1.250 / 32	26	\$ 46.17
R-FG-PT-SQ-M038-24*	1.500 / 38	18	\$ 66.60
R-FG-PT-SQ-M051-32*	2.000 / 51	11	\$ 109.10

**This Product is Available By-The-Foot Except Where Indicated**

\*These items are sold in full length spools only.

The PTFE is applied to the rope by a proprietary sinterization process. The rope is soaked repeatedly in a PTFE dispersion, dried, and then baked. The result is a PTFE coating on the rope which is soft, robust and flexible; however, it can be abrasively removed from the rope with aggressive fingernail scraping, resulting in a thinner and thinner layer of ptfе remaining with each pass. The PTFE also causes the yarns to be sealed and the small gaps between the yarns filled, resulting in an almost air-tight / liquid-tight rope.



## Square Braided PTFE Rope / Compression Packing with Graphite Impregnation

550°F / 287°C: PT-Graf™ High Temperature & Chemical Resistant



- Graphite Impregnated PTFE yarn
- Heat Resistant / Chemical Resistant
- Conformable and Resilient
- Thermally Conductive
- Self Lubricating
- pH range: 0 to 14
- Rotary pump up to 450 psi, Recip pump up to 2000 psi Valve up to 3500 psi.
- Up to 4500 FPM shaft speed
- Unique packing rope with best of both world's sealing performance where moderate temperature resistance is needed.

Used as a compression packing for pump and valve shafts and as a stuffing box packing.

High Temperature Square Braided PT-Graf™ Graphite Coated PTFE Rope				
Part Number	OD Size inch / mm	Feet per Spool	Feet per Pound	Price per Pound
R-PTFE-GR-SQ-M003-02	0.125 / 3	520	104	\$ 59.88
R-PTFE-GR-SQ-M005-03	0.187 / 5	230	46	\$ 59.88
R-PTFE-GR-SQ-M006-04	0.250 / 6	135	27	\$ 59.88
R-PTFE-GR-SQ-M008-05	0.312 / 8	85	17	\$ 59.88
R-PTFE-GR-SQ-M010-06	0.375 / 10	60	12	\$ 59.88
R-PTFE-GR-SQ-M011-07	0.437 / 11	45	9	\$ 59.88
R-PTFE-GR-SQ-M013-08	0.500 / 13	34	6.8	\$ 59.88
R-PTFE-GR-SQ-M014-09	0.562 / 14	54	5.4	\$ 59.88
R-PTFE-GR-SQ-M016-10	0.625 / 16	44	4.4	\$ 59.88
R-PTFE-GR-SQ-M019-12	0.750 / 19	32	3.2	\$ 59.88
R-PTFE-GR-SQ-M022-14	0.875 / 22	23	2.3	\$ 59.88

This Product is Available By-The-Foot

**THIS PRODUCT IS SOLD IN ONE POUND INCREMENTS**

## Fiberglass Knitted Rope, Premium Grade: *Soft Rope* 1200°F / 648°C: Very High Temperature & Heat Resistant



This knitted rope is fabricated from high quality type E fiberglass that will not burn and will withstand continuous exposure to temperatures of 1200°F / 648°C.

This material resists most acids and alkalis and is unaffected by most bleaches and solvents. It is highly flexible and conformable.

The base fiber is manufactured to the specifications of ASTM D-578, ASTM committee D13, and subcommittee D13.18.

Meets US Coast Guard specification 164.009 for incombustible material.

A Heat Treated version of this product is available – please enquire

1200°F / 648°C continuous rating, high insulation value & excellent personnel protection

Knitted Fiberglass Rope is used extensively as a seal in ovens and kiln access doors, and also as a high-temperature packing.

**Additional Technical Specifications:** Breaking Tenacity: 1.71 gf/TEX Std and Wet. Tensile Strength: 450,000-500,000 psi. Breaking Elongation: 4.81% Std and Wet. Elastic Recovery: 100% Average Stiffness: 2824.3 cn/TEX. Specific Gravity: 2.54 – 2.69. 75% tensile at 343°C. Softens 732 – 877°C. Melts 1121-1182°C.

(continued next page)

**Fiberglass Knitted Rope, Premium Grade: *Soft Rope (Continued)***  
**1200°F / 648°C: Very High Temperature & Heat Resistant**



<b>Very High Temperature &amp; Heat Resistant Fiberglass Knitted Rope Premium Grade: <i>Soft Rope</i></b>			
<b>Part Number</b>	<b>OD Size inch / mm / dash#</b>	<b>Feet / Metres per Carton</b>	<b>Price per Carton</b>
R-FG-KS-P-M002-01	0.062 / 1.6 / 01	2,500 / 762	\$ 750.00
R-FG-KS-P-M003-02	0.125 / 3 / -02	1,500 / 457	\$ 345.00
R-FG-KS-P-M005-03	0.187 / 5 / -03	2,500 / 762	\$ 675.00
R-FG-KS-P-M006-04	0.250 / 6 / -04	2,000 / 609	\$ 600.00
R-FG-KS-P-M008-05	0.312 / 8 / -05	1,500 / 457	\$ 645.00
R-FG-KS-P-M010-06	0.375 / 10 / -06	1,000 / 304	\$ 530.00
R-FG-KS-P-M011-07	0.437 / 11 / -07	750 / 228	\$ 502.50
R-FG-KS-P-M013-08	0.500 / 13 / -08	500 / 152	\$ 415.00
R-FG-KS-P-M016-10	0.625 / 16 / -10	450 / 137	\$ 436.50
R-FG-KS-P-M019-12	0.750 / 19 / -12	500 / 152	\$ 650.00
R-FG-KS-P-M022-14	0.875 / 22 / -14	300 / 91	\$ 669.00
R-FG-KS-P-M025-16	1.000 / 25 / -16	250 / 76	\$ 657.50
R-FG-KS-P-M032-20	1.250 / 32 / -20	175 / 38	\$ 862.75
R-FG-KS-P-M038-24	1.500 / 38 / -24	150 / 45	\$ 865.50
R-FG-KS-P-M044-28	1.750 / 44 / -28	90 / 27	\$ 740.70

Please call for additional discount pricing when ordering more than 6 cartons.

**This Product is NOT Available By-The-Foot – Full Carton Only**

## Fiberglass Knitted Rope, Premium Grade: *Dense Rope* 1200°F / 648°C: Very High Temperature & Heat Resistant



This knitted rope is fabricated from high quality type E fiberglass that will not burn and will withstand continuous exposure to temperatures of 1200°F / 648°C.

This material resists most acids and alkalis and is unaffected by most bleaches and solvents. It is highly flexible and conformable.

The base fiber is manufactured to the specifications of ASTM D-578, ASTM committee D13, and subcommittee D13.18.

Meets US Coast Guard specification 164.009 for incombustible material.

A Heat Treated version of this product is available – please enquire

1200°F / 648°C continuous rating, high insulation value & excellent personnel protection

Knitted Fiberglass Rope is used extensively as a seal in ovens and kiln access doors, and also as a high-temperature packing.

**Additional Technical Specifications:** Breaking Tenacity: 1.71 gf/TEX Std and Wet. Tensile Strength: 450,000-500,000 psi. Breaking Elongation: 4.81% Std and Wet. Elastic Recovery: 100% Average Stiffness: 2824.3 cn/TEX. Specific Gravity: 2.54 – 2.69. 75% tensile at 343°C. Softens 732 – 877°C. Melts 1121-1182°C.

(continued next page)

**Fiberglass Knitted Rope, Premium Grade: *Dense Rope (Continued)***  
**1200°F / 648°C: Very High Temperature & Heat Resistant**



<b>Very High Temperature &amp; Heat Resistant Fiberglass Knitted Rope Premium Grade: <i>Dense Rope</i></b>			
<b>Part Number</b>	<b>OD Size inch / mm / dash#</b>	<b>Feet / Metres per Carton</b>	<b>Price per Carton</b>
R-FG-KD-P-M003-02	0.125 / 3 / -02	1,500 / 457	\$ 450.00
R-FG-KD-P-M005-03	0.187 / 5 / -03	2,500 / 762	\$ 825.00
R-FG-KD-P-M006-04	0.250 / 6 / -04	1,500 / 457	\$ 600.00
R-FG-KD-P-M008-05	0.312 / 8 / -05	1,000 / 304	\$ 530.00
R-FG-KD-P-M010-06	0.375 / 10 / -06	700 / 213	\$ 511.00
R-FG-KD-P-M011-07	0.437 / 11 / -07	600 / 182	\$ 540.00
R-FG-KD-P-M013-08	0.500 / 13 / -08	450 / 137	\$ 585.00
R-FG-KD-P-M016-10	0.625 / 16 / -10	300 / 91	\$ 489.00
R-FG-KD-P-M019-12	0.750 / 19 / -12	350 / 106	\$ 665.00
R-FG-KD-P-M022-14	0.875 / 22 / -14	225 / 68	\$ 630.00
R-FG-KD-P-M025-16	1.000 / 25 / -16	200 / 60	\$ 686.00
R-FG-KD-P-M032-20	1.250 / 32 / -20	125 / 38	\$ 837.50
R-FG-KD-P-M038-24	1.500 / 38 / -24	100 / 30	\$ 903.00
R-FG-KD-P-M044-28	1.750 / 44 / -28	80 / 24	\$ 797.60

Please call for additional discount pricing when ordering more than 6 cartons.

Knitted Fiberglass Rope is used extensively as a seal in ovens and kiln access doors, and also as a high-temperature packing.

**This Product is NOT Available By-The-Foot – Full Carton Only**

**Additional Technical Specifications:** Breaking Tenacity: 1.71 gf/TEX Std and Wet. Tensile Strength: 450,000-500,000 psi. Breaking Elongation: 4.81% Std and Wet. Elastic Recovery: 100% Average Stiffness: 2824.3 cn/TEX. Specific Gravity: 2.54 – 2.69. 75% tensile at 343°C. Softens 732 – 877°C. Melts 1121-1182°C.



## Fiberglass Knitted Rope, Industrial Grade: *Soft Rope* 1200°F / 648°C: Very High Temperature & Heat Resistant



This knitted rope is fabricated from high quality type E fiberglass that will not burn and will withstand continuous exposure to temperatures of 1200°F / 648°C.

This material resists most acids and alkalis and is unaffected by most bleaches and solvents. It is highly flexible and conformable.

Commonly used for making gaskets on a variety of industrial and commercial boilers, ovens, furnaces. Used as a high temperature packing for shaft seals. Also used for residential wood and pellet stoves.

Other applications include a general purpose rope for industrial use, to suspend or hang objects or tie-off in high temperature environments in steel mills, aluminum and metals processing plants, etc.

A Heat Treated version of this product is available – please enquire

1200°F / 648°C continuous rating, high insulation value & excellent personnel protection

Very High Temperature & Heat Resistant Fiberglass Knitted Rope Industrial Grade: <i>Soft Rope</i>			
Part Number	OD Size inch / mm	Feet / Metres per Spool	Price per Foot / Metre
R-FG-KS-I-M002-01*	0.062 / 1.6	2,500 / 762	\$ 0.36 / \$ 1.18
R-FG-KS-I-M003-02	0.125 / 3	1,500 / 457	\$ 0.28 / \$ 0.92
R-FG-KS-I-M005-03	0.187 / 5	2,100 / 640	\$ 0.29 / \$ 0.95
R-FG-KS-I-M006-04	0.250 / 6	1,300 / 396	\$ 0.32 / \$ 1.05
R-FG-KS-I-M010-06	0.375 / 10	750 / 228	\$ 0.56 / \$ 1.84
R-FG-KS-I-M013-08	0.500 / 13	500 / 152	\$ 1.04 / \$ 3.41
R-FG-KS-I-M016-10	0.625 / 16	300 / 91	\$ 1.12 / \$ 3.67
R-FG-KS-I-M019-12	0.750 / 19	200 / 60	\$ 1.64 / \$ 5.38
R-FG-KS-I-M022-14	0.875 / 22	150 / 45	\$ 2.40 / \$ 7.87
R-FG-KS-I-M025-16	1.000 / 25	125 / 38	\$ 3.32 / \$ 10.89
R-FG-KS-I-M032-20*	1.250 / 32	85 / 25	\$ 3.40 / \$ 11.15
R-FG-KS-I-M038-24*	1.500 / 38	55 / 16	\$ 4.20 / \$ 13.77

This product is not to be used for life safety applications

**This Product is Available By-The-Foot / Metre Except Where Indicated**

\*These items are sold in full length spools only.

**Additional Technical Specifications:** Breaking Tenacity: 1.71 gf/TEX Std and Wet. Tensile Strength: 450,000-500,000 psi. Breaking Elongation: 4.81% Std and Wet. Elastic Recovery: 100% Average Stiffness: 2824.3 cn/TEX. Specific Gravity: 2.54 – 2.69. 75% tensile at 343°C. Softens 732 – 877°C. Melts 1121-1182°C.

## Fiberglass Knitted Rope, Industrial Grade: *Dense Rope* 1200°F / 648°C: Very High Temperature & Heat Resistant



This knitted rope is fabricated from high quality type E fiberglass that will not burn and will withstand continuous exposure to temperatures of 1200°F / 648°C.

This material resists most acids and alkalis and is unaffected by most bleaches and solvents. It is highly flexible and conformable.

Commonly used for making gaskets on a variety of industrial and commercial boilers, ovens, furnaces. Used as a high temperature packing for shaft seals. Also used for residential wood and pellet stoves.

Other applications include a general purpose rope for industrial use, to suspend or hang objects or tie-off in high temperature environments in steel mills, aluminum and metals processing plants, etc.

A Heat Treated version of this product is available – please enquire

1200°F / 648°C continuous rating, high insulation value & excellent personnel protection

Very High Temperature & Heat Resistant Fiberglass Knitted Rope Industrial Grade: <i>Dense Rope</i>			
Part Number	OD Size inch / mm / dash#	Feet / Metres per Spool	Price per Foot / Metre
R-FG-KD-I-M003-02	0.125 / 3 / -02	1,500 / 457	\$ 0.36 / \$ 1.18
R-FG-KD-I-M005-03	0.187 / 5 / -03	1,750 / 533	\$ 0.24 / \$ 0.79
R-FG-KD-I-M006-04	0.250 / 6 / -04	1,100 / 335	\$ 0.28 / \$ 0.92
R-FG-KD-I-M010-06	0.375 / 10 / -06	600 / 182	\$ 0.52 / \$ 1.71
R-FG-KD-I-M013-08	0.500 / 13 / -08	400 / 121	\$ 0.96 / \$ 3.15
R-FG-KD-I-M016-10	0.625 / 16 / -10	260 / 79	\$ 1.04 / \$ 3.41
R-FG-KD-I-M019-12	0.750 / 19 / -12	160 / 48	\$ 1.56 / \$ 5.12
R-FG-KD-I-M022-14	0.875 / 22 / -14	120 / 36	\$ 2.20 / \$ 7.22
R-FG-KD-I-M025-16	1.000 / 25 / -16	100 / 30	\$ 3.16 / \$ 10.36
R-FG-KD-I-M032-20 *	1.250 / 32 / -20	70 / 21	Full Spool \$ 261.10
R-FG-KD-I-M038-24 *	1.500 / 38 / -24	55 / 16	Full Spool \$ 311.85
R-FG-KD-I-M051-32 *	2.000 / 51 / -32	50 / 15	Full Spool \$ 685.00
R-FG-KD-I-M064-40 *	2.500 / 64 / -40	100 / 30	Full Spool \$ 1980.00
R-FG-KD-I-M076-48 *	3.000 / 76 / -48	100 / 30	Full Spool \$ 2960.00
R-FG-KD-I-M102-64 *	4.000 / 102 / -64	100 / 30	Full Spool \$ 4750.00

This product is not to be used for life safety applications

**This Product is Available By-The-Foot / Metre Except Where Indicated**

\* These items are sold in full length spools only.

**Additional Technical Specifications:** Breaking Tenacity: 1.71 gf/TEX Std and Wet. Tensile Strength: 450,000-500,000 psi. Breaking Elongation: 4.81% Std and Wet. Elastic Recovery: 100% Average Stiffness: 2824.3 cn/TEX. Specific Gravity: 2.54 – 2.69. 75% tensile at 343°C. Softens 732 – 877°C. Melts 1121-1182°C.

## Fiberglass Twisted Rope: Premium Grade

### 1200°F / 648°C: Very High Temperature & Heat Resistant



This high temperature and heat resistant knitted rope is fabricated from high quality type E fiberglass that will not burn and will withstand continuous exposure to temperatures of 1200°F / 648°C.

This material resists most acids and alkalis and is unaffected by most bleaches and solvents. It is highly flexible and conformable.

A Heat Treated version of this product is available – please enquire

1200°F / 648°C continuous rating, high insulation value & excellent personnel protection

Very High Temperature & Heat Resistant Fiberglass Twisted Rope Premium Grade			
Part Number	OD Size inch / mm	Feet / Metres per Spool	Price per Foot / Metre
R-FG-T-M003-02	0.125 / 3 / -02	2,525 / 769	\$ 0.24 / \$ 0.79
R-FG-T-M006-04	0.250 / 6 / -04	1,275 / 388	\$ 0.44 / \$ 1.44
R-FG-T-M010-06	0.375 / 10 / -06	969 / 295	\$ 0.52 / \$ 1.71
R-FG-T-M013-08	0.500 / 13 / -08	523 / 159	\$ 1.04 / \$ 3.41
R-FG-T-M016-10	0.625 / 16 / -10	305 / 92	\$ 1.40 / \$ 4.59
R-FG-T-M019-12	0.750 / 19 / -12	168 / 51	\$ 3.08 / \$ 10.10
R-FG-T-M022-14	0.875 / 22 / -14	144 / 43	\$ 3.60 / \$ 11.81
R-FG-T-M025-16	1.000 / 25 / -16	114 / 34	\$ 4.40 / \$ 14.43
<i>R-FG-T-M032-20 *</i>	1.250 / 32 / -20	50 / 15	Full Spool \$ 387.88
<i>R-FG-T-M038-24 *</i>	1.500 / 38 / -24	50 / 15	Full Spool \$ 625.00
<i>R-FG-T-M051-32 *</i>	2.000 / 51 / -32	27 / 8	Full Spool \$ 803.79

**This Product is Available By-The-Foot Except Where Indicated**

\* These items are sold in full length spools only.

**Additional Technical Specifications:** Breaking Tenacity: 1.71 gf/TEX Std and Wet. Tensile Strength: 450,000-500,000 psi. Breaking Elongation: 4.81% Std and Wet. Elastic Recovery: 100% Average Stiffness: 2824.3 cn/TEX. Specific Gravity: 2.54 – 2.69. 75% tensile at 343°C. Softens 732 – 877°C. Melts 1121-1182°C.

## Fiberglass Braided Square Rope: Premium Grade (Square Dry Packing Rope) 1200°F / 648°C: Very High Temperature & Heat Resistant



This square braided rope is fabricated from high quality type E fiberglass that will not burn and will withstand continuous exposure to temperatures of 1200°F / 648°C.

This material resists most acids and alkalis and is unaffected by most bleaches and solvents. It is highly flexible and conformable.

Braided square rope is often used as a square dry packing.

A Heat Treated version of this product is available – please enquire

Very High Temperature & Heat Resistant Fiberglass Braided Square Rope - Premium Grade				
Part Number	OD Size inch / mm	Feet / Metres per Spool Large Spool / Std Spool		Price per Foot / Metre
R-FG-SQ-M006-04-X	0.250 / 6 / -04	375 / 114	650 / 198	\$ 1.60 / \$ 5.25
R-FG-SQ-M008-05	0.312 / 8 / -05	315 / 96	N/A	\$ 1.87 / \$ 6.13
R-FG-SQ-M010-06-X	0.375 / 10 / -06	285 / 86	370 / 112	\$ 2.10 / \$ 6.89
R-FG-SQ-M011-07	0.437 / 11 / -07	212 / 64	N/A	\$ 2.80 / \$ 9.18
R-FG-SQ-M013-08-X	0.500 / 13 / -08	162 / 49	220 / 67	\$ 3.67 / \$ 12.04
R-FG-SQ-M014-09	0.562 / 14 / -09	127 / 38	N/A	\$ 4.70 / \$ 15.42
R-FG-SQ-M016-10-X	0.625 / 16 / -10	105 / 32	160 / 48	\$ 5.67 / \$ 18.60
R-FG-SQ-M019-12-X	0.750 / 19 / -12	75 / 22.8	110 / 33	\$ 7.93 / \$ 26.01
R-FG-SQ-M022-14-X	0.875 / 22 / -14	55 / 16.7	88 / 26	\$ 10.83 / \$35.52
R-FG-SQ-M025-16-X	1.000 / 25 / -16	45 / 13.7	70 / 21	\$ 13.23 / \$ 43.39
R-FG-SQ-M032-20 *	1.250 / 32 / -20	26 / 7.9	N/A	Full Spool \$ 496.60
R-FG-SQ-M038-24-X *	1.500 / 38 / -24	18 / 5.4	30 / 9	Full Spool \$ 496.80
R-FG-SQ-M051-32-X *	2.000 / 51 / -32	11 / 3.3	17 / 5	Full Spool \$ 496.43

For the "X" value: Use "L" for Large Spool and "S" for Standard Spool

**This Product is Available By-The-Foot Except Where Indicated**

\* These items are sold in full length spools only.

**Additional Technical Specifications:** Breaking Tenacity: 1.71 gf/TEX Std and Wet. Tensile Strength: 450,000-500,000 psi. Breaking Elongation: 4.81% Std and Wet. Elastic Recovery: 100% Average Stiffness: 2824.3 cn/TEX. Specific Gravity: 2.54 – 2.69. 75% tensile at 343°C/649°F. Softens 732 – 877°C/1349°F-1610°F. Melts 1121-1182°C/2049°F-2159°F.

## Kevlar Overbraided Fiberglass Rope

320°F / 160°C: Very High Temperature & Heat Resistant



- This rope's core can be either soft or dense knitted fibreglass round rope.
- Overbraided with genuine Kevlar.
- Cut and wear resistant – results in a long lasting seal for high cycle access doors.
- Cost savings over a 100% Kevlar rope.

320°F / 160°C continuous rating, high insulation value & excellent personnel protection

Kevlar Overbraided Fiberglass Rope High Temperature & Heat Resistant			
Part Number	OD Size inch / mm / dash#	Feet / Metres per Spool	Price per Carton
R-FG-KOVB-M006-04	0.250 / 6 / -04	1500 /	\$ On Request
R-FG-KOVB-M010-06	0.375 / 10 / -06	700 /	\$ On Request
R-FG-KOVB-M013-08	0.500 / 13 / -08	500 /	\$ On Request
R-FG-KOVB-M016-10	0.625 / 16 / -10	300 /	\$ On Request
R-FG-KOVB-M019-12	0.750 / 19 / -12	300 /	\$ On Request
R-FG-KOVB-M022-14	0.875 / 22 / -14	200 /	\$ On Request
R-FG-KOVB-M025-16	1.000 / 25 / -16	200 /	\$ On Request
R-FG-KOVB-M032-20	1.250 / 32 / -20	125 /	\$ On Request
R-FG-KOVB-M038-24	1.500 / 38 / -24	100 /	\$ On Request
R-FG-KOVB-M044-28	1.750 / 44 / -28	90 /	\$ On Request
R-FG-KOVB-M051-32	2.000 / 51 / -32	50 /	\$ On Request

This product is available full carton only



## Fiberglass High Compression Oven / BBQ / Smoker Door & Lid Gasket Rope - Hollow Metal Knit Core with Clip Mounting 1200°F / 648°C: Very High Temperature & Heat Resistant Fiberglass Gasket Rope



- The two sizes of this rope gasket are both constructed of a heat treated fiberglass braid sleeve with a 304 stainless steel knitted mesh hollow sleeve core, with a stainless steel mounting clip spaced every 3 inches.
- Provides excellent compression and pushback, with high cycle life.
- The braid is a high quality type E fiberglass filament yarn that will not burn and will withstand continuous exposure to temperatures of 1200°F / 648°C.
- This material resists most acids and alkalis and is unaffected by most bleaches and solvents. It is highly flexible and conformable.
- Heat treated to result in an extremely clean surface that sheds extremely few fibers and no organic odors. Suitable for most clean room, paint booth and food service applications.
- This gasket is commonly used on consumer self-cleaning ovens as a door seal. Popular with bbq and smokers door gasketing.



**Fiberglass Compression Oven / BBQ / Smoker Door & Lid Gasket Rope with Hollow Metal Core with Clip Mounting (Continued)**

**1200°F / 648°C: Very High Temperature & Heat Resistant Fiberglass Gasket Rope**

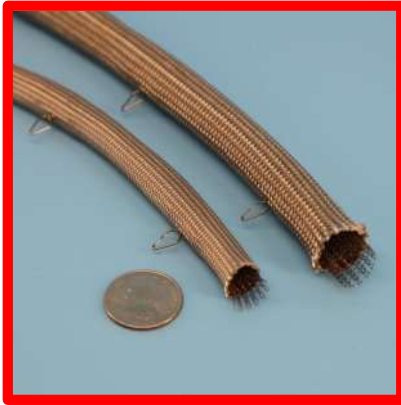

For applications such as commercial, industrial and scientific ovens and dryers, this gasket rope is easily installed by drilling a 1/8 inch hole into the door or frame on the equipment, and then inserting the self expanding clip into the hole. Maximum mounting material thickness is 1/16 inch. Spacing between clips is 3" (7.6cm). Clip length is .42" with no clip compression. Undesired clips can be partially removed by cutting the protruding portion of the clip with wire cutters.

The 0.57" OD rope has an ultimate compression to .110" without damage. Optimum compression range is from .15" to .40". The 0.42" OD rope has an ultimate compression to .110" without damage. Optimum compression range is from .15" to .23".

The hollow knit metal sleeve core of the 0.57" rope is 1/2 inch ID. Rope weighs 0.70 oz per foot / 65 g per meter. The hollow knit metal sleeve core of the 0.42" rope is 3/8 inch ID. Rope weighs 0.53 oz per foot / 49 g per meter.

<b>Very High Temperature &amp; Heat Resistant Heat Treated Fiberglass Braided Rope Gasket with Stainless Steel Knit Hollow Core</b> <b>Oven / BBQ / Smoker lid and door sealing</b>			
Part Number	OD Size inch / mm	Feet / Metres per coil	Price per coil / Foot
R-FG-HMC-CLIP-0.570-M0144-025	0.57 / 14.4	25 / 7.6	\$ 187.23 / coil
R-FG-HMC-CLIP-0.570-M0144-050	0.57 / 14.4	50 / 15.2	\$ 354.47 / coil
R-FG-HMC-CLIP-0.570-M0144-250	0.57 / 14.4	250 / 76.2	\$ 1427.50 / coil
R-FG-HMC-CLIP-0.570-M0144-FT	0.57 / 14.4	By The Foot	\$ 8.36 / foot
R-FG-HMC-CLIP-0.420-M0107-025	0.42 / 10.7	25 / 7.6	\$ 154.38 / coil
R-FG-HMC-CLIP-0.420-M0107-050	0.42 / 10.7	50 / 15.2	\$ 292.22 / coil
R-FG-HMC-CLIP-0.420-M0107-250	0.42 / 10.7	250 / 76.2	\$ 1178.17 / coil
R-FG-HMC-CLIP-0.420-M0107-FT	0.42 / 10.7	By The Foot	\$ 6.90 / foot

**This Product is Available By-The-Foot / Metre**

**Minimum Order is 6 feet. Cutting Room Fee is Waived**

\* See website for additional details and oven model numbers.

## Fiberglass Knitted Rope with Stainless or Inconel Mesh Core - Industrial Grade

1200°F / 648°C: Very High Temperature & Heat Resistant



- This rope has a metal mesh core, providing a resilient push-back for applications such as kiln and lab oven doors.
- For clean room and paint booth applications, use part number F-FG-HT-MC instead.
- The stainless rope core is then covered with a knit high quality type E fiberglass texturized yarn that will not burn and will withstand continuous exposure to temperatures of 1200°F / 648°C.
- This material resists most acids and alkalis and is unaffected by most bleaches and solvents. It is highly flexible and conformable.
- This photo shows the 0.75" OD size rope - it has a 0.40" core.

1200°F / 648°C continuous rating, high insulation value & excellent personnel protection

Very High Temperature & Heat Resistant Texturized Fiberglass Braided Rope with Stainless Mesh Core				
Part Number	OD Size inch / mm / dash#	Feet / Metres per Spool	Stainless Core Price per foot / Metre	Inconel Core Price per foot / Metre
R-FG-K-MC-M013-08-X	0.500 / 13 / -08	100 / 30.4	\$ 4.08 / \$ 13.38	\$ 13.06 / \$ 42.83
R-FG-K-MC-M016-10-X	0.625 / 16 / -10	100 / 30.4	\$ 7.96 / \$ 26.11	\$ 25.47 / \$ 83.54
R-FG-K-MC-M019-12-X	0.750 / 19 / -12	100 / 30.4	\$ 8.52 / \$ 27.95	\$ 27.26 / \$ 89.41
R-FG-K-MC-M022-14-X	0.875 / 22 / -14	50 / 15.2	\$ 12.32 / \$ 40.41	\$ 39.42 / \$ 129.29
R-FG-K-MC-M025-16-X	1.000 / 25 / -16	50 / 15.2	\$ 13.56 / \$ 44.48	\$ 43.39 / \$ 142.32
R-FG-K-MC-M029-18-X	1.125 / 29 / -18	25 / 7.6	\$ 14.32 / \$ 46.97	\$ 45.82 / \$ 150.29

For the "X" value in the part number: Substitute "S" for 304 Stainless and "I" for Inconel.

This product is normally available in full spools only - may be available by-the-foot/metre

## Heat Treated Fiberglass Braided Rope with Stainless Mesh Core – Premium Grade - Clean Room & Paint Shop Door Gasket Suitable 1200°F / 648°C: Very High Temperature & Heat Resistant

Extremely clean heat treated braid for clean-room & paint shop gasket applications



- This rope has a stainless steel or inconel mesh core, providing a resilient push-back for applications such as kiln and lab oven doors, paint shop drying ovens.
- The core is then overbraided with a high quality type E fiberglass filament yarn that will not burn and will withstand continuous exposure to temperatures of 1200°F / 648°C.
- This material resists most acids and alkalis and is unaffected by most bleaches and solvents. It is highly flexible and conformable.
- The heat treated filament yarn provides an extremely smooth and clean surface to the rope shell, and is excellent for use in clean room and paint shop ovens where loose fibers are not tolerated.

1200°F / 648°C continuous rating, high insulation value & excellent personnel protection

### Very High Temperature & Heat Resistant Filament Fiberglass Braided Rope with Stainless Mesh Core – Premium Grade Clean Room and Paint Booth Oven Applications

Part Number	OD Size inch / mm / dash#	Feet / Metres per Spool	304 Stainless Core Price per foot / Metre	Inconel Core Price per foot / Metre
R-FG-HT-MC-M013-08-X	0.500 / 13 / -08	100 / 914	\$ 4.89 / \$ 15.98	\$ 15.65 / \$ 51.33
R-FG-HT-MC-M016-10-X	0.625 / 16 / -10	100 / 609	\$ 9.15 / \$ 29.93	\$ 29.28 / \$ 96.04
R-FG-HT-MC-M019-12-X	0.750 / 19 / -12	100 / 243	\$ 9.79 / \$ 32.04	\$ 31.33 / \$ 102.76
R-FG-HT-MC-M022-14-X	0.875 / 22 / -14	100 / 182	\$ 14.17 / \$ 46.33	\$ 45.34 / \$ 148.72
R-FG-HT-MC-M025-16-X	1.000 / 25 / -16	100 / 243	\$ 15.60 / \$ 50.99	\$ 49.92 / \$ 163.74
R-FG-HT-MC-M029-18-X	1.125 / 29 / -18	100 / 182	\$ 16.46 / \$ 53.85	\$ 52.67 / \$ 172.76

For the "X" value in the part number: Substitute "S" for 304 Stainless and "I" for Inconel.

This product is normally available in full spools only - by-the-foot/metre lengths may be available



## Fiberglass Gasket & Seal Ropes with Stainless Steel Wire Jacket for Kiln & Oven Doors - Custom Sized 1200°F / 648°C: Very High Temperature & Heat Resistant



- Stainless Knit Overbraid provides superior abrasion resistance
- Single or Double Rope - with rope or wire mesh cores.
- Designed for high-cycle kiln doors.
- Helps prevent cold spots in the kiln.
- Improves efficiency and controls heat loss by providing a superior seal.
- Part Number R-FG-SWJ-MXXX-XX-Y.  
(XXX-XX is the size, Y is the style)

Fabricated from high quality type E fiberglass that will not burn and will withstand continuous exposure to temperatures of 1200°F / 648°C.

This material resists most acids and alkalis and is unaffected by most bleaches and solvents. It is highly flexible and conformable. The base fiber is manufactured to the specifications of ASTM D-578, ASTM committee D13, and subcommittee D13.18.

The seals are then jacketed with a knitted 304 stainless steel wire mesh, providing significant abrasion resistance. These gaskets are also available with a 304 Stainless Mesh Core

Supplied cut to length, each seal can be custom fabricated from a wide variety of diameters and configurations to provide the precise thickness and depth of seal for each U channel design specification. Pre-engineering each seal insures a simple, labor saving solution to the problem of containing heat. This efficient design reduces fuel consumption and eliminates cold spots in brick/tile kilns which can cause some of the brick or tile to be under-fired.

Pricing is on application.



**Fiberglass Kiln & Oven Door Gasket Seal Rope with Twin  
 Stainless Steel Wire Rope Cores and Stainless Steel Wire Jacket  
 1200°F / 648°C: Very High Temperature & Heat Resistant**



- 1.5" x 2.0" overall oval dimension.
- Two 7/8" 304 Stainless mesh cores. Fiberglass overbraid on each core.
- Fiberglass overbraid of both cores.
- Stainless steel jacket overbraid.
- Available in maximum 100 foot length.
- Stainless Knit Overbraid jacket provides superior abrasion resistance
- Designed for high-cycle kiln, oven and other high temperature access doors.
- Helps prevent cold spots in the kiln.
- Improves efficiency and controls heat loss by providing a superior seal.
- The overbraid is fabricated from high quality type E fiberglass that will not burn and will withstand continuous exposure to temperatures of 1200°F / 648°C.

Weight of seal is 0.866 lb/ft.

This material resists most acids and alkalis and is unaffected by most bleaches and solvents. It is highly flexible and conformable. The base fiber is manufactured to the specifications of ASTM D-578, ASTM committee D13, and subcommittee D13.18.

The seals are then jacketed with a knitted 304 stainless steel wire mesh, providing significant abrasion resistance.

Other configurations and sizes are available. This efficient design reduces fuel consumption and eliminates cold spots in brick/tile kilns which can cause some of the brick or tile to be under-fired.

<b>Very High Temperature &amp; Heat Resistant</b> <b>1.5" x 2.0" Oven, Kiln and Furnance access door seal</b> <b>304SS Mesh Core - Heat Treated DeltaGlass Over-braid - 304SS Outer Mesh Jacket</b>		
Part Number	Length	Price
R-FG-MC-SWJ-FE15500-1.5X2.0-100	100 feet / 30 metres	\$ 2409.30
R-FG-MC-SWJ-FE15500-1.5X2.0-50	50 feet / 15 metres	\$ 1338.50
R-FG-MC-SWJ-FE15500-1.5X2.0-25	25 feet / 7.5 metres	\$ 803.10
R-FG-MC-SWJ-FE15500-1.5X2.0-1	By-the-foot / metre	\$ 38.55 / ft / \$ 126.44 / m

## Stainless Core with Fiberglass Overbraid & Stainless Outer Overbraid - Turbine Engine Exhaust Gas Tunnel/Collector Gasket Seal 1200°F / 648°C: Very High Temperature & Heat Resistant



- Designed for gas turbine engine exhaust sealing.
- 304 Stainless Mesh Core.
- Heat Treated E-Glass core cover.
- 304 Stainless Mesh Overbraid Outer Cover.
- Improves efficiency and controls heat loss by providing a superior seal.
- P/N 4900159-23, P/N 4900159-38 and P/N 4900159-48 supplied cut to length.
- P/N F-E15600-00-00 available by-the-foot.
- Custom rope seals for GE H, GE F Class, GE B&E Class, GE Frame 5, GE LM Class, GE GT11/GT24 (Legacy Alstrom), Siemens 800, Siemens H, Siemens V Class, Siemens Aero (Legacy Rolls Royce), Siemens 501 F&G, Siemens/Westinghouse 501 A-D, Mitsubishi J Unites, Mitsubishi 501 F&G, PW Power Systems FT4, PW Power Systems FT8.

Very High Temperature & Heat Resistant Turbine Exhaust Gas Tunnel Gasket Sealing Rope - 1 1/8" / 29mm OD 304SS Mesh Core - Heat Treated DeltaGlass Over-braid - 304SS Outer Mesh Jacket		
Part Number	Length	Price
R-TS-4900159-23	23 feet / 7.01 metres	\$ 444.59
R-TS-4900159-38	38 feet / 11.58 metres	\$ 734.54
R-TS-4900159-48	48 feet / 14.63 metres	\$ 927.84
R-TS-FE15600-XX	By-the-foot / metre	\$ 21.67 / ft / \$ 71.08 / m
R-TS-FE15600-BULK	200 feet / 60.96 metres	\$ 3479.40

NOTE: Some of our resellers are incorrectly stating the 4900159 and FE15600 products are made with Inconel steel as standard - these part numbers are only available with 304SS as standard as the original OEM spec calls for 304SS. Inconel is available by special order only and the part number will be different. The Stainless version is completely suitable for gas turbine use.

The stainless core cover is fabricated from high quality heat treated type E fiberglass that will not burn and will withstand continuous exposure to temperatures of 1200°F / 648°C.

The E-glass material resists most acids and alkalis and is unaffected by most bleaches and solvents. It is highly flexible and conformable. The base fiber is manufactured to the specifications of ASTM D-578, ASTM committee D13, and subcommittee D13.18.

**Knitted Fiberglass Rope with Graphite Coating / Impregnation:  
Round Soft Rope  
1200°F / 648°C: Very High Temperature**



- Graphite Coating / Impregnation

Graphite adds lubrication to result in a very slippery rope but does not add electrical conductivity.

Resists molten splash and splatter very well as it cannot stick to the graphite.

Service temperatures up to 1200°F / 648°C.

Used as a compression packing for pump and valve shafts.

Graphite coating / impregnation process results in an approximate 1/4 depth penetration into the fiberglass.

<b>Very High Temperature Knitted Fiberglass Round Rope with Graphite Coating / Impregnation: <i>Soft Rope</i></b>			
<b>Part Number</b>	<b>OD Size inch / mm</b>	<b>Feet per Spool</b>	<b>Price per Foot / Meter</b>
R-FG GR-KS-01	0.062 / 1.6	2,500	\$ 1.44 / \$ 4.72
R-FG GR-KS-02	0.125 / 3	1,500	\$ 1.48 / \$ 4.85
R-FG GR-KS-03	0.187 / 5	2,100	\$ 1.53 / \$ 5.02
R-FG GR-KS-04	0.250 / 6	1,300	\$ 1.57 / \$ 5.15
R-FG GR-KS-06	0.375 / 10	750	\$ 2.04 / \$ 6.69
R-FG GR-KS-08	0.500 / 13	500	\$ 3.76 / \$ 12.33
R-FG GR-KS-10	0.625 / 16	300	\$ 4.40 / \$ 14.43
R-FG GR-KS-12	0.750 / 19	200	\$ 7.00 / \$ 22.96
R-FG GR-KS-14	0.875 / 22	150	\$ 7.84 / \$ 25.72
R-FG GR-KS-16	1.000 / 25	125	\$ 12.48 / \$ 40.93
<i>R-FG-GR-KS-20 *</i>	1.250 / 32	85	Spool Price \$ 1298.80
<i>R-FG-GR-KS-24 *</i>	1.500 / 38	55	Spool Price \$ 856.35

\* These items are sold in full length spools only.

**This Product is Available By The Foot**

## Knitted Fiberglass Rope with Graphite Impregnation: *Round Dense Rope* 1200°F / 648°C: Very High Temperature



- Graphite Coating / Impregnation

Graphite adds lubrication to result in a very slippery rope but not electrical conductivity.

Resists molten splash and splatter very well as it cannot stick to the graphite.

Service temperatures up to 1200°F / 648°C.

Used as a compression packing for pump and valve shafts.

Graphite coating / impregnation process results in an approximate 1/4 depth penetration into the fiberglass.

Very High Temperature Knitted Fiberglass Round Rope with Graphite Coating / Impregnation: <i>Dense Rope</i>			
Part Number	OD Size inch / mm	Feet per Spool	Price per Foot / Meter
R-FG-GR-KD-02	0.125 / 3	1,500	\$ 0.76 / \$ 2.49
R-FG-GR-KD-03	0.187 / 5	1,750	\$ 0.84 / \$ 2.76
R-FG-GR-KD-04	0.250 / 6	1,100	\$ 1.28 / \$ 4.20
R-FG-GR-KD-06	0.375 / 10	600	\$ 2.20 / \$ 7.22
R-FG-GR-KD-08	0.500 / 13	400	\$ 4.20 / \$ 13.78
R-FG-GR-KD-10	0.625 / 16	260	\$ 4.88 / \$ 16.01
R-FG-GR-KD-12	0.750 / 19	160	\$ 7.76 / \$ 25.45
R-FG-GR-KD-14	0.875 / 22	120	\$ 8.68 / \$ 28.47
R-FG-GR-KD-16	1.000 / 25	100	\$ 13.84 / \$ 45.40
<i>R-FG-GR-KD-20 *</i>	1.250 / 32	70	Spool Price \$ 989.10
<i>R-FG-GR-KD-24 *</i>	1.500 / 38	55	Spool Price \$ 951.50
<i>R-FG-GR-KD-32 *</i>	2.000 / 51	50	Spool Price \$ 8867.00
<i>R-FG-GR-KD-40 *</i>	2.500 / 64	100	Spool Price \$ 8867.00
<i>R-FG-GR-KD-48 *</i>	3.000 / 76	100	Spool Price \$ 9766.00
<i>R-FG-GR-KD-64 *</i>	4.000 / 102	100	Spool Price \$ 17688.00

\* These items are sold in full length spools only.

**This Product is Available By The Foot**

## Square Braided Fiberglass Square Braid Rope with Graphite Coating / Impregnation

1200°F / 648°C: Very High Temperature



- Graphite Coating / Impregnation
- Graphite adds lubrication to result in a very slippery rope but not electrical conductivity.
- Resists molten splash and splatter very well as it cannot stick to the graphite.
- Service temperatures up to 1200°F / 648°C.
- Used as a compression packing for pump and valve shafts.
- Graphite coating / impregnation process results in an approximate 1/4 depth penetration into the fiberglass.

Very High Temperature Square Braided Fiberglass Rope with Graphite Coating / Impregnation				
Part Number	OD Size inch / mm	Feet per Spool	Feet per Pound	Price per foot
R-FG-GR-SQ-04	0.250 / 6	375	15	\$ 7.16
R-FG-GR-SQ-05	0.312 / 8	315	12.6	\$ 7.46
R-FG-GR-SQ-06	0.375 / 10	285	11.4	\$ 6.73
R-FG-GR-SQ-07	0.437 / 11	212	8.5	\$ 9.10
R-FG-GR-SQ-08	0.500 / 13	162	6.5	\$ 11.80
R-FG-GR-SQ-09	0.562 / 14	127	5.1	\$ 15.03
R-FG-GR-SQ-10	0.625 / 16	105	4.2	\$ 18.25
R-FG-GR-SQ-12	0.750 / 19	75	3	\$ 25.56
R-FG-GR-SQ-14	0.875 / 22	55	2.2	\$ 34.85
R-FG-GR-SQ-16	1.000 / 25	45	1.8	\$ 42.60
R-FG-GR-SQ-20*	1.250 / 32	26	1.05	\$ 58.41
R-FG-GR-SQ-24*	1.500 / 38	18	.75	\$ 81.78
R-FG-GR-SQ-32*	2.000 / 51	11	.45	\$ 136.30

**THIS PRODUCT IS SOLD IN ONE POUND INCREMENTS**



**Pure Graphite Rope / Packing - Square Braided**  
**900°F / 482°C: GraphPack™ Very High Temperature & Chemical**  
**Resistant**  
**Available Plain / with Inconel Wire Insert / with Carbon re-enforced corners**



- 100% Graphite yarns
- Heat Resistant / Chemical Resistant
- Conformable and Resilient
- Thermally Conductive
- Self Lubricating
- pH range: 0 to 14
- 3000 psi standard rope; 4000 psi wire reinforced
- Up to 4000 FPM shaft speed
- Carbon fiber corner yarns available for greater wear resistance

Used as a compression packing for pump and valve shafts and as a stuffing box packing.

Made from flexible graphite yarn composed of exfoliated high purity crystalline mineral graphite (flake graphite).

Useable to 900°F / 482°C in normal air atmosphere; 1800°F / 982°C in steam or mild oxidization atmospheres/media and 5400°F / 2982°C in non-oxidizing atmospheres/media

(continued next page)

**Pure Graphite Rope / Packing - Square Braided (Continued)**  
**900°F / 482°C: GraphPack™ Very High Temperature & Chemical Resistant**  
**Available Plain / with Inconel Wire Insert / with Carbon re-enforced corners**



**Very High Temperature Square Braided Pure Graphite Rope**  
**Plain / Wire Re-enforced / Carbon Corners**

Part Number	OD Size inch / mm	Feet per Spool			Feet per Pound			Price per Pound		
		Plain	Wire	Carbon	Plain	Wire	Carbon	Plain	Wire	Carbon
R-GR-SQ-02-X	0.125 / 3.2	254	228	N/A	127	114	N/A	\$25.20	\$27.99	N/A
R-GR-SQ-03-X	0.187 / 4.7	114	102	N/A	57	51	N/A	\$25.20	\$27.99	N/A
R-GR-SQ-04-X	0.250 / 6	160	145	N/A	32	29	N/A	\$25.20	\$27.99	N/A
R-GR-SQ-05-X	0.312 / 8	102	93	110	20	18	22	\$25.20	\$27.99	\$117.90
R-GR-SQ-06-X	0.375 / 10	66	66	80	13	13	16	\$25.20	\$27.99	\$117.90
R-GR-SQ-07-X	0.437 / 11	54	49	60	10	9	12	\$25.20	\$27.99	\$107.21
R-GR-SQ-08-X	0.500 / 13	41	37	47	8	7	9	\$25.20	\$27.99	\$107.21
R-GR-SQ-09-X	0.562 / 14	65	59	N/A	6.5	5.9	N/A	\$25.20	\$27.99	N/A
R-GR-SQ-10-X	0.625 / 16	53	48	63	5.3	4.8	6.3	\$25.20	\$27.99	\$107.21
R-GR-SQ-12-X	0.750 / 19	36	33	44	3.6	3.3	4.4	\$25.20	\$27.99	\$98.71
R-GR-SQ-14-X	0.875 / 22	26	24	33	2.6	2.4	3.3	\$25.20	\$27.99	\$98.71
R-GR-SQ-16-X	1.000 / 25	20	18	26	2	1.8	2.6	\$25.20	\$27.99	\$98.71

For the "X" Value in the part number: Substitute "P" for Plain, "W" for Wire, "C" for Carbon

**Available Full Spool and 1 Pound Increments**

## Fiberglass with Vermiculite Coated Rope: *Soft* 1500°F / 815°C: FlameShield™ 1500 High Temperature & Heat Resistant



Vermiculite coated fiberglass rope is manufactured from texturized fiberglass yarns then coated with Vermiculite, a 100% inorganic dispersion.

Third party certified to meet the requirements of ASTM E 162, ASTM E 662 & SMP 800-C for surface flammability, smoke and toxic gas generation.

Vermiculite coated rope will withstand temperatures up to 1500°F / 815°C constant exposure with excursions to 2000°F / 1093°F. Also offers abrasion resistant stability.

Soft rope has an approximate compression of 50% when pressed with thumb pressure.

Suitable as an architectural rope for public venues seeking a nautical appearance with a fire rated product.

High insulation value & excellent personnel protection. Can be used as an alternative to sleeve and tapes when wrapped over hot pipes for burn protection.

An alternative to asbestos and ceramic based textiles. Highly flexible and minimal shrinkage.

- Meets Federal Railroad Administration requirements for surface flammability and rate of smoke generation.

<b>Very High Temperature &amp; Heat Resistant Vermiculite Coated Fiberglass Knitted Rope: <i>Soft</i></b>			
<b>Part Number</b>	<b>OD Size inch / mm / dash#</b>	<b>Feet / metres per Spool</b>	<b>Price per Foot / Metre</b>
R-FG-VC-KS-M002-01*	0.062 / 1.6 / -01	2,500 / 762	\$ 0.44 / \$ 1.45
R-FG-VC-KS-M003-02	0.125 / 3 / -02	1,500 / 457	\$ 0.45 / \$ 1.48
R-FG-VC-KS-M005-03	0.187 / 5 / -03	2,100 / 640	\$ 0.46 / \$ 1.51
R-FG-VC-KS-M006-04	0.250 / 6 / -04	1,300 / 396	\$ 0.47 / \$ 1.55
R-FG-VC-KS-M010-06	0.375 / 10 / -06	750 / 228	\$ 0.64 / \$ 2.10
R-FG-VC-KS-M013-08	0.500 / 13 / -08	500 / 152	\$ 1.04 / \$ 3.42
R-FG-VC-KS-M016-10	0.625 / 16 / -10	300 / 91	\$ 1.12 / \$ 3.67
R-FG-VC-KS-M019-12	0.750 / 19 / -12	200 / 60	\$ 1.99 / \$ 6.53
R-FG-VC-KS-M022-14	0.875 / 22 / -14	150 / 45	\$ 2.44 / \$ 8.00
R-FG-VC-KS-M025-16	1.000 / 25 / -16	125 / 38	\$ 3.64 / \$ 11.94
R-FG-VC-KS-M032-20*	1.250 / 32 / -20	85 / 25	\$ 4.57 / \$ 14.99
R-FG-VC-KS-M038-24*	1.500 / 38 / -24	55 / 16	\$ 5.90 / \$ 19.35

### This Product is Available By-The-Foot Except Where Indicated

Fiber Type:	E Glass	Specific Gravity:	2.54-2.69
Breaking Tenacity:	1.71 gf/TEX. Std. 1.71 gf/TEX Wet	Tensile Strength:	450,000-500,000 psi.
Breaking Elongation:	4.81% Std. 4.81% Wet	Elastic Recovery:	100%
Average Stiffness:	2824.3 cn/TEX		
Effect of Heat:	Will not burn; Retains 75% tensile at 343°C; Softens at 732-877°C; Melts at 1121-1182°C		
Effect of Acids and Alkalis:	Resistance to acids is fair. Good resistance to most alkalis.		
Effect of Bleaches and Solvents:	Unaffected		

**Minimum Order for .5" OD and less is 20 feet. Minimum order for .625" OD and larger is 10 feet.**

\* These items are sold in full length spools only.

## Vermiculite Coated Fiberglass Rope: *Dense* 1500°F / 815°C: FlameShield™ 1500: High Temperature & Heat Resistant



Vermiculite coated fiberglass rope is manufactured from texturized fiberglass yarns then coated with Vermiculite, a 100% inorganic dispersion.

Third party certified to meet the requirements of ASTM E 162, ASTM E 662 & SMP 800-C for surface flammability, smoke and toxic gas generation.

Vermiculite coated rope will withstand temperatures up to 1500°F / 815°C constant exposure with excursions to 2000°F / 1093°F. Also offers abrasion resistant stability.

Dense rope has an approximate compression of 25% when pressed with thumb pressure.

Suitable as an architectural rope for public venues seeking a nautical appearance with a fire rated product.

High insulation value & excellent personnel protection. Can be used as an alternative to sleeve and tapes when wrapped over hot pipes for burn protection.

An alternative to asbestos and ceramic based textiles. Highly flexible and minimal shrinkage.

- Meets Federal Railroad Administration requirements for surface flammability and rate of smoke generation.

### Very High Temperature & Heat Resistant Vermiculite Coated Fiberglass Knitted Rope: *Dense*

Part Number	OD Size inch / mm / -dash#	Feet per Spool	Price per foot
R-FG-VC-KD-M003-02	0.125 / 3 / -02	1,500	\$ 0.48
R-FG-VC-KD-M005-03	0.187 / 5 / -03	1,750	\$ 0.50
R-FG-VC-KD-M006-04	0.250 / 6 / -04	1,100	\$ 0.52
R-FG-VC-KD-M010-06	0.375 / 10 / -06	600	\$ 0.88
R-FG-VC-KD-M013-08	0.500 / 13 / -08	400	\$ 1.52
R-FG-VC-KD-M016-10	0.625 / 16 / -10	260	\$ 2.44
R-FG-VC-KD-M019-12	0.750 / 19 / -12	160	\$ 3.32
R-FG-VC-KD-M022-14	0.875 / 22 / -14	120	\$ 5.04
R-FG-VC-KD-M025-16	1.000 / 25 / -16	100	\$ 5.52
R-FG-VC-KD-M032-20 *	1.250 / 32 / -20	70	\$ 6.37
R-FG-VC-KD-M038-24 *	1.500 / 38 / -24	55	\$ 11.80
R-FG-VC-KD-M051-32 *	2.000 / 51 / -32	50	\$ 23.70
R-FG-VC-KD-M064-40 *	2.500 / 64 / -40	100	\$ 39.57
R-FG-VC-KD-M076-48 *	3.000 / 76 / -48	100	\$ 58.73
R-FG-VC-KD-M102-64 *	4.000 / 102 / -64	100	\$ 88.33

#### This Product is Available By-The-Foot Except Where Indicated

Fiber Type:	E Glass	Specific Gravity:	2.54-2.69
Breaking Tenacity:	1.71 gf/TEX. Std. 1.71 gf/TEX Wet	Tensile Strength:	450,000-500,000 psi.
Breaking Elongation:	4.81% Std. 4.81% Wet	Elastic Recovery:	100%
Average Stiffness:	2824.3 cn/TEX		
Effect of Heat: Will not burn; Retains 75% tensile at 343°C; Softens at 732-877°C; Melts at 1121-1182°C			
Effect of Acids and Alkalis; Resistance to acids is fair. Good resistance to most alkalis.			
Effect of Bleaches and Solvents: Unaffected			

Minimum Order for .5" OD and less is 20 feet. Minimum order for .625" OD and larger is 10 feet.

\* These items are sold in full length spools only.

## Vermiculite Coated Fiberglass Rope: *Twisted* 1500°F / 815°C: FlameShield™ 1500 Very High Temperature & Heat Resistant



Vermiculite coated fiberglass rope is manufactured from fiberglass yarns which are then then coated with Vermiculite, a 100% inorganic dispersion.

Third party certified to meet the requirements of ASTM E 162, ASTM E 662 & SMP 800-C for surface flammability, smoke and toxic gas generation.

Vermiculite coated rope will withstand temperatures up to 1500°F / 815°C constant exposure with short excursions to 2000°F / 1093°F. Also offers abrasion resistant stability.

Suitable as an architectural rope for public venues seeking a nautical appearance with a fire rated product.

High insulation value & excellent personnel protection. Can be used as an alternative to sleeve and tapes when wrapped over hot pipes for burn protection.

An alternative to asbestos and ceramic based textiles. Highly flexible and minimal shrinkage.

- Meets Federal Railroad Administration requirements for surface flammability and rate of smoke generation.

Very High Temperature & Heat Resistant Vermiculite Coated Fiberglass Twisted Rope			
Part Number	OD Size inch / mm	Feet per Spool	Price per foot
R-FG-VC-T-M003-02	0.125 / 3 / -02	2,525	\$ 0.32
R-FG-VC-T-M006-04	0.250 / 6 / -04	1,275	\$ 1.20
R-FG-VC-T-M010-06	0.375 / 10 / -06	969	\$ 1.60
R-FG-VC-T-M013-08	0.500 / 13 / -08	523	\$ 2.88
R-FG-VC-T-M016-10	0.625 / 16 / -10	305	\$ 4.60
R-FG-VC-T-M019-12	0.750 / 19 / -12	168	\$ 8.36
R-FG-VC-T-M022-14	0.875 / 22 / -14	144	\$ 9.72
R-FG-VC-T-M025-16	1.000 / 25 / -16	114	\$ 12.32
R-FG-VC-T-M032-20*	1.250 / 32 / -20	77	\$ 16.33
R-FG-VC-T-M038-24*	1.500 / 38 / -24	50	\$ 32.47
R-FG-VC-T-M051-32*	2.000 / 51 / -32	27	\$ 69.47

### This Product is Available By-The-Foot Except Where Indicated

Fiber Type:	E Glass	Specific Gravity:	2.54-2.69
Breaking Tenacity:	1.71 gf/TEX. Std. 1.71 gf/TEX Wet	Tensile Strength:	450,000-500,000 psi.
Breaking Elongation:	4.81% Std. 4.81% Wet	Elastic Recovery:	100%
Average Stiffness:	2824.3 cn/TEX		

Effect of Heat: Will not burn; Retains 75% tensile at 343°C; Softens at 732-877°C; Melts at 1121-1182°C  
Effect of Acids and Alkalis; Resistance to acids is fair. Good resistance to most alkalis.  
Effect of Bleaches and Solvents: Unaffected

\*These items are sold in full length spools only.



## Vermiculite Coated Fiberglass Braided Square Rope / Dry Packing 1500°F / 815°C: FlameShield™ 1500 Very High Temperature & Heat Resistant



Vermiculite coated fiberglass braided square rope is manufactured from texturized fiberglass yarns then coated with Vermiculite, a 100% inorganic dispersion.

Third party certified to meet the requirements of ASTM E 162, ASTM E 662 & SMP 800-C for surface flammability, smoke and toxic gas generation.

Vermiculite coated rope will withstand temperatures up to 1500°F / 815°C constant exposure with excursions to 2000°F / 1093°F. Also offers abrasion resistant stability.

Square rope is often used as a square dry packing. Suitable as an architectural rope for public venues seeking a nautical appearance with a fire rated product.

High insulation value & excellent personnel protection. Can be used as an alternative to sleeve and tapes when wrapped over hot pipes for burn protection.

- Highly flexible and minimal shrinkage. Meets Federal Railroad Administration requirements for surface flammability and rate of smoke generation.

Very High Temperature & Heat Resistant Vermiculite Coated Fiberglass Square Braided Rope – Square Dry Packing			
Part Number	OD Size inch / mm	Feet per Spool / Pound	Price per foot / pound (sold by pound)
R-FG-VC-SQ-0.250-M006	0.250 / 6	375 / 15	\$ 3.68 / \$ 51.26
R-FG-VC-SQ-0.312-M008	0.312 / 8	315 / 12.6	\$ 4.16 / \$ 52.46
R-FG-VC-SQ-0.375-M010	0.375 / 10	285 / 11.4	\$ 3.99 / \$ 45.55
R-FG-VC-SQ-0.437-M011	0.437 / 11	212 / 8.5	\$ 4.88 / \$ 41.50
R-FG-VC-SQ-0.500-M013	0.500 / 13	162 / 6.5	\$ 6.39 / \$ 41.58
R-FG-VC-SQ-0.562-M014	0.562 / 14	127 / 5.1	\$ 8.16 / \$ 41.61
R-FG-VC-SQ-0.625-M016	0.625 / 16	105 / 4.2	\$ 9.87 / \$ 41.47
R-FG-VC-SQ-0.750-M019	0.750 / 19	75 / 3	\$ 13.81 / \$ 41.43
R-FG-VC-SQ-0.875-M022	0.875 / 22	55 / 2.2	\$ 18.84 / \$ 41.44
R-FG-VC-SQ-1.000-M025	1.000 / 25	45 / 1.8	\$ 23.00 / \$ 41.41
<i>R-FG-VC-SQ-1.250-M032 *</i>	1.250 / 32	26 / 1.05	\$ 33.19 / \$ 37.86
<i>R-FG-VC-SQ-1.500-M038 *</i>	1.500 / 38	18 / 0.75	\$ 50.60 / \$ 37.95
<i>R-FG-VC-SQ-2.000-M051 *</i>	2.000 / 51	11 / .45	\$ 84.72 / \$ 38.12

**This Product is Available By-The-Pound Except Where Indicated. Standard spool is 25 pounds**

Fiber Type:	E Glass	Specific Gravity:	2.54-2.69
Breaking Tenacity:	1.71 gf/TEX. Std. 1.71 gf/TEX Wet	Tensile Strength:	450,000-500,000 psi.
Breaking Elongation:	4.81% Std. 4.81% Wet	Elastic Recovery:	100%
Average Stiffness:	2824.3 cn/TEX		
Effect of Heat:	Will not burn; Retains 75% tensile at 343°C; Softens at 732-877°C; Melts at 1121-1182°C		
Effect of Acids and Alkalis:	Resistance to acids is fair. Good resistance to most alkalis.		
Effect of Bleaches and Solvents:	Unaffected		

\*These sizes are sold in full length spools only.

## Silica Knitted Cord / Rope - Small Size

High Temperature, Heat, Direct Flame, Molten Metal & Weld Splatter Resistant

- Used as a welding hose and cable suspension/tie-off cord in ship building and other hot work locations due to its non-combustive properties.

1800°F / 982°C: InSilMax™

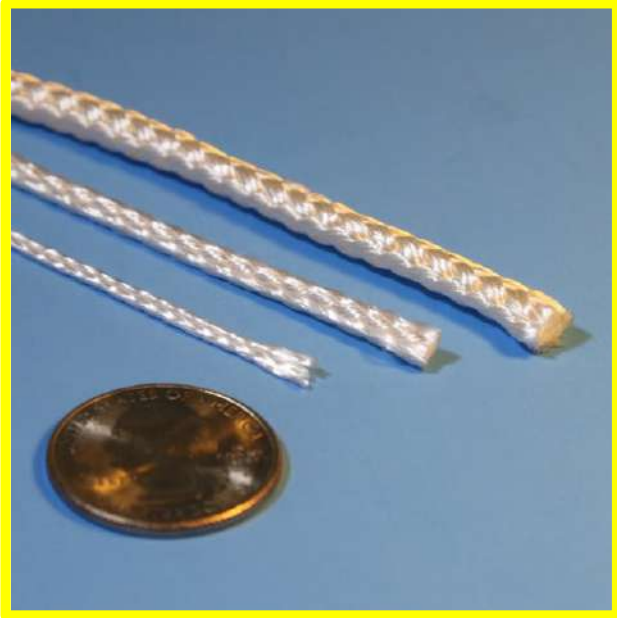

- An alternative to asbestos and ceramic based products.
- Highly flexible and minimal shrinkage.
- Good abrasion resistance and tensile strength.
- Melts above 3000°F / 1648°C.
- Produced from an extremely pure base fiber (SiO<sub>2</sub>) and can survive harsh environments.
- Provides excellent burn-through protection from molten metal, direct flame and weld splatter.

InSilMax™ Extreme Temperature Heat & Direct Flame Resistant Knitted Silica Cord/Rope							
Part Number	Size			Max Spool Length		Breaking Strength * N / kg / lbs	Price per Foot / Metre
	inch / mm / -dash			feet / metres			
R-S-KDC-M0015-01	.060	1.5	-01	650	200	70 / 7.1 / 15.7	\$ 0.21 / \$ 0.69
R-S-KDC-M003-02	.120	3	-02	650	200	90 / 9.2 / 20.2	\$ 0.34 / \$ 1.12
R-S-KDC-M006-04	.250	6	-04	650	200	110 / 11.2 / 24.7	\$ 1.40 / \$ 4.60

\$50.00 Minimum Order

**This Product is Available By-The-Foot/Metre**

\* Breaking strength is only valid for new product at 72°F / 22°C. Strength decreases with increased temperature and with use.

## Silica Knitted Rope: Dense; High Temperature, Heat, Flame, Molten Metal & Weld Splatter Resistant

1800°F / 982°C: InSilMax™ / 2000°F / 1093°C: InSilMax™ XT



- An alternative to asbestos and ceramic based products.
- Highly flexible and minimal shrinkage.
- High abrasion resistance and tensile strength.
- Melts above 3000°F / 1648°C.
- Produced from an extremely pure base fiber (SiO<sub>2</sub>) and can survive harsh environments.
- Silica based materials provide burn-through protection from molten metal and weld splatter.

### InSilMax™ & InSilMax™ XT Extreme Temperature Heat Flame Resistant Knitted Silica Rope

Part Number	Size			Length per Spool		InSilMax™ Price per Foot / Metre	InSilMax™ XT Price per Foot / Metre
	inch	mm	-dash	feet	metres		
R-S-KD-M006-04-X	.250	6	-04	1138	346	\$ 2.16 / \$ 7.08	\$ 2.48 / \$ 8.14
R-S-KD-M010-06-X	.375	10	-06	625	190	\$ 2.40 / \$ 7.87	\$ 2.76 / \$ 9.05
R-S-KD-M013-08-X	.500	13	-08	375	114	\$ 2.88 / \$ 9.45	\$ 3.31 / \$ 10.87
R-S-KD-M016-10-X	.625	16	-10	250	76	\$ 4.04 / \$ 13.25	\$ 4.65 / \$ 15.24
R-S-KD-M019-12-X	.750	19	-12	205	62	\$ 4.88 / \$ 16.01	\$ 5.61 / \$ 18.41
R-S-KD-M022-14-X	.875	22	-14	138	42	\$ 6.24 / \$20.47	\$ 7.18 / \$23.54
R-S-KD-M025-16-X	1.000	25	-16	113	34	\$ 7.92 / \$ 25.98	\$ 9.11 / \$ 29.88
R-S-KD-M032-20-X*	1.250	32	-20	75	22	\$ 822.00 / spool	\$ 945.30 / spool
R-S-KD-M038-24-X*	1.500	38	-24	50	15	\$ 581.50 / spool	\$ 668.72 / spool

For the "X" value in the part number specify:

"IM" for 1800°F / 982°C InSilMax™

"XT" for 2000°F / 1093°C InSilMax™ XT

\* These items are sold in full length spools only.  
Quantity per spool can be +/- 10%.

**This Product is Available By-The-Foot Except Where Indicated**

## Silica Twisted Rope: High Temperature, Heat, Flame, Molten Metal & Weld Splatter Resistant

1800°F / 982°C: InSilMax™ / 2000°F / 1093°C: InSilMax™ XT  
Extreme



- An alternative to asbestos and ceramic based textiles.
- Highly flexible and minimal shrinkage.
- High abrasion resistance and tensile strength.
- Melts above 3000°F / 1648°C.
- Produced from an extremely pure base fiber (SiO<sub>2</sub>) and can be used at 2000°F / 1093°C continuously with excursions to 3000°F / 1650°C.
- Silica based materials provide burn-through protection from molten metal and weld splatter.

InSilMax™ & InSilMax™ XT Extreme Temperature Heat Flame Resistant Twisted Silica Rope						
Part Number	Size			Length per Spool feet / metres	InSilMax™ Price	InSilMax™ XT Price
	inch / mm	-dash				
R-S-T-M006-04-X*	.250	6	-04	100 / 30	\$ 387.00 / spool	\$ 445.05 / spool
R-S-T-M010-06-X*	.375	10	-06	100 / 30	\$ 591.00 / spool	\$ 679.65 / spool
R-S-T-M013-08-X*	.500	13	-08	100 / 30	\$ 762.00 / spool	\$ 876.30 / spool
R-S-T-M019-12-X*	.750	19	-12	100 / 30	\$ 1,373.00 / spool	\$ 1,578.95 / spool
R-S-T-M025-16-X*	1.000	25	-16	75 / 22	\$ 1,887.50 / spool	\$ 2,170.63 / spool

For the "X" value in the part number specify:

"IM" for 1800°F / 982°C InSilMax™

"XT" for 2000°F / 1093°C InSilMax™ XT

\* These items are sold in full length spools only.  
Quantity per spool can be +/- 10%.

**This Product is Available By-The-Foot Except Where Indicated**

## Square Braided Silica Rope: High Temperature, Heat, Flame, Molten Metal & Weld Splatter Resistant

1800°F / 982°C: InSilMax™ / 2000°F / 1093°C: InSilMax™ XT



- An alternative to asbestos and ceramic based textiles.
- Highly flexible and minimal shrinkage.
- High abrasion resistance and tensile strength.
- Melts above 3000°F / 1648°C.
- Produced from an extremely pure base fiber (SiO<sub>2</sub>) and can be used at 2000°F / 1093°C continuously with excursions to 3000°F / 1650°C.
- Silica based materials provide burn-through protection from molten metal and weld splatter.
- Used as a square dry packing.

### InSilMax™ & InSilMax™ XT Extreme High Temperature Heat Flame Resistant Square Braided Rope (Square Dry Packing Rope)

Part Number	Size			Length per Spool feet / metres	InSilMax™ Price per foot	InSilMax™ XT Price per foot
	inch	mm	-dash			
R-S-SQ-M006-04-X	.250	6	-04	825 / 251	\$ 3.13	\$ 3.60
R-S-SQ-M010-06-X	.375	10	-06	415 / 126	\$ 5.43	\$ 6.25
R-S-SQ-M013-08-X	.500	13	-08	250 / 76	\$ 6.76	\$ 7.78
R-S-SQ-M016-10-X	.625	16	-10	135 / 41	\$ 11.13	\$ 12.80
R-S-SQ-M019-12-X	.750	19	-12	105 / 32	\$ 15.20	\$ 17.48
R-S-SQ-M022-14-X	.875	22	-14	75 / 22.8	\$ 19.40	\$ 22.31
R-S-SQ-M025-16-X	1.000	25	-16	65 / 19.8	\$ 21.50	\$ 24.73
R-S-SQ-M032-20-X*	1.250	32	-20	42 / 12.8	\$ 39.83	\$ 45.81
R-S-SQ-M038-24-X*	1.500	38	-24	32 / 9.7	\$ 46.98	\$ 54.01
R-S-SQ-M051-32-X*	2.000	51	-32	19 / 5.7	\$ 113.13	\$ 130.10

-15% for Full Spool Purchase

For the "X" value in the part number specify:

"IM" for 1800°F / 982°C InSilMax™

"XT" for 2000°F / 1093°C InSilMax™ XT

\*These items are sold in full length spools only. Quantity per spool can be +/- 10%.



## Ceramic Fiber Rope: Premium & Industrial Grade

### 2300°F / 1260°C: CerMax™ Extreme High Temperature, Heat & Flame Resistant



- A replacement and an alternative to asbestos. Highly flexible and minimal shrinkage.
- Melts above 3000°F / 1648°C.
- Produced from an extremely pure base fiber and can be used at 2300°F / 1260°C continuously with excursions to 3000°F / 1650°C.

#### CerMax™ Extreme High Temperature +Plus, Heat & Flame Resistant Ceramic Fiber Braided Rope: Premium & Industrial Grade

Part Number	Size			Spool length		Price per spool		Price per foot	
	inch	mm	-dash	feet	metres	Premium	Industrial	Premium	Industrial
R-C-B-X-M006-04-Y	.250	6	-04	700	213	\$ 770.83	\$ 616.66	\$ 1.72	\$ 1.32
R-C-B-X-M010-06-Y	.375	10	-06	370	112	\$ 957.88	\$ 766.31	\$ 4.04	\$ 3.11
R-C-B-X-M013-08-Y	.500	13	-08	525	160	\$ 1129.16	\$ 903.33	\$ 3.35	\$ 2.58
R-C-B-X-M016-10-Y	.625	16	-10	350	106	\$ 1146.79	\$ 917.43	\$ 5.11	\$ 3.93
R-C-B-X-M019-12-Y	.750	19	-12	250	76	\$ 1151.71	\$ 921.37	\$ 7.18	\$ 5.52
R-C-B-X-M022-14-Y	.875	22	-14	180	54	\$ 1178.29	\$ 942.63	\$ 10.21	\$ 7.85
R-C-B-X-M025-16-Y	1.000	25	-16	125	38	\$ 1206.06	\$ 964.85	\$ 15.04	\$ 11.57
R-C-B-X-M029-20-Y	1.250	32	-20	100	30	\$ 1224.01	\$ 979.21	\$ 19.08	\$ 14.68
R-C-B-X-M032-24-Y	1.500	38	-24	75	22	\$ 1232.64	\$ 986.11	\$ 25.64	\$ 19.72
R-C-B-X-M051-32-Y	2.000	51	-32	48	14	\$ 1243.23	\$ 994.58	\$ 40.40	\$ 31.08

For the "X" value in the part number: use "P" to specify Premium grade  
use "I" to specify Industrial grade

For the "Y" value in the part number: use "SP" to specify full spool  
use "FT" to specify By-The-Foot

**Minimum Order for this product is \$50.00 for By-The-Foot Lengths**

## Ceramic Twisted Fiber Rope: Premium & Industrial Grade 2300°F / 1260°C: CerMax™ Extreme High Temperature, Heat & Flame Resistant



- A replacement and an alternative to asbestos. Highly flexible and minimal shrinkage.
- Melts above 3000°F / 1648°C.
- Produced from an extremely pure base fiber and can be used at 2300°F / 1260°C continuously with excursions to 3000°F / 1650°C.

CerMax™ Extreme High Temperature +Plus, Heat & Flame Resistant Ceramic Fiber Twisted Rope: Premium & Industrial Grade									
Part Number	Size			Spool length		Price per spool		Price per foot	
	inch	mm	-dash	feet	metres	Premium	Industrial	Premium	Industrial
R-C-T-X-M006-04-Y	.250	6	-04	900	274	\$ 700.16 / \$ 560.13		\$ 1.21 / \$ 0.93	
R-C-T-X-M010-06-Y	.375	10	-06	510	155	\$ 723.05 / \$ 578.44		\$ 2.21 / \$ 1.70	
R-C-T-X-M013-08-Y	.500	13	-08	750	228	\$ 1196.71 / \$ 957.37		\$ 2.48 / \$ 1.91	
R-C-T-X-M016-10-Y	.625	16	-10	500	152	\$ 1214.03 / \$ 971.22		\$ 3.78 / \$ 2.91	
R-C-T-X-M019-12-Y	.750	19	-12	375	114	\$ 1235.59 / \$ 988.47		\$ 5.14 / \$ 3.95	
R-C-T-X-M022-14-Y	.875	22	-14	275	83	\$ 1247.02 / \$ 997.61		\$ 7.07 / \$ 5.44	
R-C-T-X-M025-16-Y	1.000	25	-16	225	68	\$ 1267.98 / \$ 1014.38		\$ 8.79 / \$ 6.76	
R-C-T-X-M029-20-Y	1.250	32	-20	155	47	\$ 1279.66 / \$ 1023.73		\$ 12.88 / \$ 9.91	
R-C-T-X-M032-24-Y	1.500	38	-24	110	33	\$ 1293.15 / \$ 1034.52		\$ 18.34 / \$ 14.11	
R-C-T-X-M051-32-Y	2.000	51	-32	55	16	\$ 1306.48 / \$ 1045.18		\$ 37.08 / \$ 28.50	

For the "X" value in the part number: use "P" to specify Premium grade  
use "I" to specify Industrial grade

For the "Y" value in the part number: use "SP" to specify full spool  
use "FT" to specify By-The-Foot

**Minimum Order for this product is \$50.00 for By-The-Foot Lengths**

## Ceramic Fiber Square Braided Rope - Dry Packing

### Premium & Industrial Grade

#### 2300°F / 1260°C: CerMax™ Extreme High Temperature, Heat & Flame Resistant



- A replacement and an alternative to asbestos. Highly flexible and minimal shrinkage.
- Melts above 3000°F / 1648°C.
- Produced from an extremely pure base fiber and can be used at 2300°F / 1260°C continuously with excursions to 3000°F / 1650°C.
- A rope with inconel wire insert is also available.

### CerMax™ Extreme High Temperature, Heat & Flame Resistant Ceramic Fiber Square Braided Rope: Premium & Industrial Grade

Part Number	Size inch / mm / -dash			Spool length feet / metres		Price per spool Premium / Industrial		Price per foot Premium / Industrial	
	R-C-SQ-X-M006-04-Y	.250	6	-04	450	137	\$ 664.55 / \$ 531.64	\$ 2.30 / \$ 1.77	
R-C-SQ-X-M010-06-Y	.375	10	-06	240	73	\$ 697.30 / \$ 557.84	\$ 4.52 / \$ 3.48		
R-C-SQ-X-M013-08-Y	.500	13	-08	350	106	\$ 1209.22 / \$ 967.38	\$ 5.39 / \$ 4.15		
R-C-SQ-X-M016-10-Y	.625	16	-10	250	76	\$ 1200.26 / \$ 960.21	\$ 7.49 / \$ 5.76		
R-C-SQ-X-M019-12-Y	.750	19	-12	165	50	\$ 1216.93 / \$ 973.54	\$ 11.51 / \$ 8.85		
R-C-SQ-X-M022-14-Y	.875	22	-14	125	38	\$ 1226.84 / \$ 981.47	\$ 15.30 / \$ 11.77		
R-C-SQ-X-M025-16-Y	1.000	25	-16	100	30	\$ 1245.69 / \$ 996.55	\$ 19.42 / \$ 14.94		
R-C-SQ-X-M029-20-Y	1.250	32	-20	70	21	\$ 1264.53 / \$ 1011.62	\$ 28.18 / \$ 21.68		
R-C-SQ-X-M032-24-Y	1.500	38	-24	50	15	\$ 1277.41 / \$ 1021.93	\$ 39.86 / \$ 30.66		
R-C-SQ-X-M051-32-Y	2.000	51	-32	33	10	\$ 1284.09 / \$ 1027.27	\$ 60.69 / \$ 46.69		

For the "X" value in the part number: use "P" for Premium grade; use "I" to for Industrial grade

For the "Y" value in the part number: use "SP" for full spool; use "FT" to specify By-The-Foot

**Minimum Order for this product is \$50.00 for By-The-Foot Lengths**

**Ceramic Fiber Square Braided Rope - Dry Packing - with Wire Insert**  
**Premium & Industrial Grade**  
**2300°F / 1260°C: CerMax™ Extreme High Temperature, Heat & Flame Resistant**



- A replacement and an alternative to asbestos. Highly flexible and minimal shrinkage.
- Melts above 3000°F / 1648°C.
- Produced from an extremely pure base fiber and can be used at 2300°F / 1260°C continuously with excursions to 3000°F / 1650°C.
- Inconel wire insert for added dimensional stability and tensile strength enhancement.

CerMax™ Extreme High Temperature, Heat & Flame Resistant Ceramic Fiber Square Braided Rope: Wire Inserted - Premium & Industrial Grade						
Part Number	Size			Spool length		Price per spool Premium / Industrial
	inch	mm	-dash	feet	metres	
R-C-SQ-WI-X-M006-04	.375	10	-06	500	152	\$ 908.28 / \$ 726.63
R-C-SQ-WI-X-M013-08	.500	13	-08	300	91	\$ 908.28 / \$ 726.63
R-C-SQ-WI-X-M016-10	.625	16	-10	215	65	\$ 908.28 / \$ 726.63
R-C-SQ-WI-X-M019-12	.750	19	-12	150	45	\$ 908.28 / \$ 726.63
R-C-SQ-WI-X-M022-14	.875	22	-14	110	33	\$ 908.28 / \$ 726.63
R-C-SQ-WI-X-M025-16	1.000	25	-16	88	26	\$ 908.28 / \$ 726.63
R-C-SQ-WI-X-M029-20	1.250	32	-20	60	18	\$ 908.28 / \$ 726.63
R-C-SQ-WI-X-M032-24	1.500	38	-24	43	13	\$ 908.28 / \$ 726.63
R-C-SQ-WI-X-M051-32	2.000	51	-32	27	8	\$ 908.28 / \$ 726.63

For the "X" value in the part number: use "P" to specify Premium grade  
 use "I" to specify Industrial grade

### **CerMax Rope Technical Data**

CerMax is alumino-silicate based refractory fiber. White and odorless. Available with a fiberglass reinforcement. Some organic binder is present, and will smoke-off at elevated temperatures. Once the organics have smoked-off, the product will turn white again. If smoke free operation is required, then it should be heat treated before use.

**Chemical & Physical Data:** Total  $Al_2O_3$  and  $SiO_2$  > 97% ( $Al_2O_3$ : 47%);  $Fe_2O_3$  <1.1%. Weight Loss (1800°F) 8-10%; Refractory Fiber content >85%. Fiber diameter: 2 - 4 microns; Fiber length: 100 - 250 mm. Fiber shrinkage (1800°F, 3 hr) <3.5%

**Thermal Conductivity:** 570°F: 0.84 BTU/ft<sup>2</sup> °F/in (0.12 W/m °K). 1100°F: 0.91 BTU/ft<sup>2</sup> °F/in (0.13 W/m °K). 1800°F: 1.19 BTU/ft<sup>2</sup> °F/in (0.17 W/m °K).



**Stainless Steel 304 Mesh Rope - Inconel 600 Mesh Rope**  
 Stainless Maximum Temperature 1200°F / 648°C: Inconel 600 Maximum  
 Temperature 2300°F / 1260°C



- Excellent Compressability and pushback
- Excellent EMI / RFI Gasket
- Used as a bulb core material in tadpole tapes
- Available by-the-foot

304 Stainless Steel Mesh Rope					
OD Size inch / mm		Part Number	Price per Foot	Price per Carton	Feet per Carton
1/4"	6	R-SS-M006-04	\$ 3.05	\$ 2030.00	1000
5/16"	8	R-SS-M008-05	\$ 4.60	\$ 2300.00	1000
3/8"	10	R-SS-M010-06	\$ 5.14	\$ 3855.00	1500
1/2"	13	R-SS-M013-08	\$ 7.93	\$ 3930.00	1000
5/8"	16	R-SS-M016-10	\$ 11.54	\$ 4616.00	800
3/4"	19	R-SS-M019-12	\$ 14.74	\$ 4422.00	600
7/8"	22	R-SS-M022-14	\$ 24.54	\$ 4908.00	400
1"	25	R-SS-M025-16	\$ 29.46	\$ 4419.00	300
1 1/4"	32	R-SS-M032-20	\$ 44.14	\$ 5517.50	250
1 3/8"	35	R-SS-M035-22	\$ 51.40	\$ 3855.00	150
Inconel 600 Mesh Rope					
1/4"	6	R-IN-M006-04	\$ 9.60	\$ 4800.00	1000
3/8"	10	R-IN-M010-06	\$ 18.40	\$ 13800.00	1500
1/2"	13	R-IN-M013-08	\$ 20.66	\$ 10330.00	1000
5/8"	16	R-IN-M016-10	\$ 31.60	\$ 12640.00	800
3/4"	19	R-IN-M019-12	\$ 42.54	\$ 12762.00	600
7/8"	22	R-IN-M022-14	\$ 62.00	\$ 12400.00	400
1"	25	R-IN-M025-16	\$ 93.46	\$ 14019.00	300
1 1/4"	32	R-IN-M032-20	\$ 129.60	\$ 6480.00	100
1 3/8"	35	R-IN-M035-22	\$ 142.46	\$ 7123.00	100
1 7/8"	48	R-IN-M048-30	\$ 244.94	\$ 9185.25	75

## Wire, Cable, Harness and Hose Overbraid Service Thermal Protection / Abrasion Protection / Organization

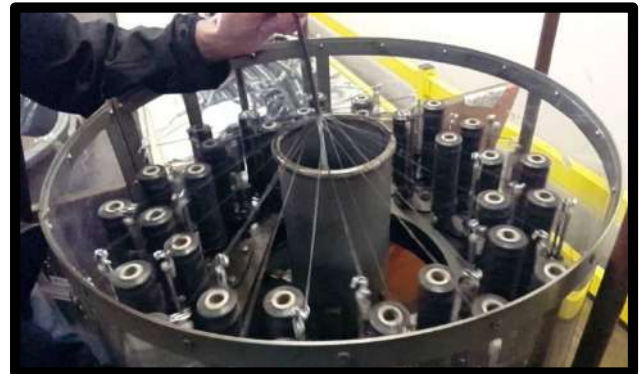
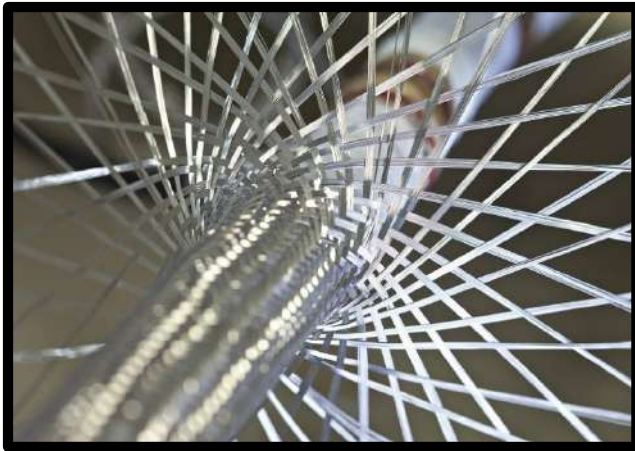

Our in-house braiding capability and experience allows us to provide exceptional quality and a timely response to protect your ropes, wiring, cables and hoses.

Available overbraid materials include e-fibreglass filament, Kevlar<sup>®</sup>, Nomex<sup>®</sup>, Nylon, PET, Polyester and Stainless wire

Please provide a description of your materials and sizing to allow us to provide an accurate quotation.

Kevlar<sup>®</sup> & Nomex<sup>®</sup> are trademarks of DuPont<sup>™</sup>

**High Temperature, Heat, Flame, Fire, Molten Metal & Weld Splatter Protection Materials**

*Fax Orders: 610-340-9054 Telephone Orders: 610-906-3549 [orders@abthermal.com](mailto:orders@abthermal.com)*

---

---

# Fabric / Cloth / Fireblanket

FlameShield™ Fiberglass Reinforced Thermal Transfer Insulator Fabric .....	4-1
FlameShield™ Fiberglass Reinforced Silicone Rubber Sheet Roll AMS3320 / AMS3315 .....	4-3
FlameShield™ Fiberglass Reinforced Silicone Rubber Coated Fabric - Premium Grade .....	4-4
FlameShield™ Fiberglass Reinforced Silicone Rubber Coated Fabric - Premium Grade FDA Compliant .....	4-5
FlameShield™ SplashShield™ Silicone Rubber 1-Side Coated Fiberglass, Heavy Duty .....	4-6
FlameShield™ SplashShield™ Silicone Rubber 2-Side Coated Fiberglass, Light / Medium / HDuty .....	4-8
Dual-Coat™ Heat Reflecting Silicone Rubber Sealed Fiberglass .....	4-10
Tuff-Flex™ Tacky Cloth Rubberized Fiberglass .....	4-11
Fiberglass with soft PTFE Coating Gasket Fabric .....	4-13
DeltaGlass™ Fiberglass with PTFE Resin Impregnation and Self Adhesive - Premium Grade .....	4-14
DeltaGlass™ Fiberglass with PTFE Resin Impregnation and Self Adhesive - Industrial Grade .....	4-16
DeltaGlass™ Fiberglass with PTFE Resin Impregnation and Self Adhesive - FDA Compliant .....	4-17
DeltaGlass™ Fiberglass with PTFE Resin Impregnation and Self Adhesive - Anti-Static .....	4-19
DeltaGlass™ E-Glass Fiberglass: Plain .....	4-21
DeltaGlass™ E-Glass Fiberglass: Plain, Heat Treated .....	4-23
DeltaGlass™ E-Glass Fiberglass: WeldShield - Neoprene/Latex Coated .....	4-24
DeltaGlass™ E-Glass Fiberglass: HHP31 Wire Inserted .....	4-25
DeltaGlass™ E-Glass Fiberglass: SteelTex Wire Inserted .....	4-26
DeltaGlass™ E-Glass Fiberglass: Wire Inserted with FAA Approval .....	4-27
Aramid Fabric with Aluminized PET Film Coating - Heat Reflecting .....	4-28
DeltaGlass™ E-Glass Fiberglass with Aluminum Foil Coating - MIL Spec .....	4-29
DeltaGlass™ E-Glass Fiberglass with Aluminized PET Film Coating .....	4-30
AluMax Heat Reflecting Fabric for Protective Clothing .....	4-31
AluFlake™ Heat Reflecting Fabrics with Aluminum flake impregnation .....	4-32
Heat Reflecting Fabric with Stainless Steel Foil Coating .....	4-33
Basalt Rock Fibre Fabric .....	4-34

ProSil Silica/Fiberglass Blended Fabric .....	4-35
DeltaMax™ S-Glass Fiberglass Fabric .....	4-36
DeltaGlass™ Fiberglass Fabric with Vermiculite Coating .....	4-37
InSilMax™ Silica with silicone rubber one side coated fabric .....	4-39
InSilMax™ Silica Fabric .....	4-40
InSilMax™ XT Silica Fabric .....	4-41
AluMax™ Alumina Fabric .....	4-42
Ceramic Paper .....	4-43
CerMax™ Ceramic Fibre Fabric .....	4-44
CerMax™ Ceramic Fibre Fabric - Industrial Grade .....	4-46
Graphite Sheet & Roll & Laminated Sheet .....	4-48
Stainless Steel & Inconel Knitted Mesh Fabric .....	4-49
InSilMax™ Molten Liquid Metal Filter Mesh .....	4-50

## Sheet Materials

GraphTek™ Flexible Graphite Sheet and Roll .....	4-50
FlameShield™ Silicone Rubber Square Sheeting .....	4-51
FlameShield™ Silicone Rubber Sheet Roll - Premium Grade .....	4-52
FlameShield™ Silicone Rubber Sheet Roll - Highest Temperature Grade .....	4-53
FlameShield™ Silicone Rubber Sheet Roll - Commercial Grade Red/Grey/Black .....	4-54
FlameShield™ Silicone Rubber Sheet Roll - FDA Food Grade White .....	4-56
FlameShield™ Silicone Rubber Sheet Roll - Medical Grade .....	4-57
FlameShield™ Silicone Rubber Sheet Roll - Translucent .....	4-58
FlameShield™ Silicone Rubber Sheet Roll - Fluorosilicone .....	4-59
FlameShield™ Silicone Rubber Sheet Roll - Electrically Conductive .....	4-60
FlameShield™ Silicone Rubber Sheet Roll - High Strength .....	4-61
FlameShield™ Silicone Rubber Sheet Roll - Extreme Low Temperature Flexibility .....	4-62
FlameShield™ Silicone Rubber Sheet Roll - Silicone Vacuum Blanket .....	4-63



**Silicone Thermal Transfer Insulator Pad Fabrics:**  
**Fiberglass reinforced and polyimide reinforced**  
**-150°F to 400°F / -100°C to 204°C: DeltaGlass™**



- Type 4500 fabric was designed for LED and Power semiconductor applications for maximum reliability.
- Fiberglass core or Kapton® core.
- This material resists heat, humidity and shock.
- Conforms to surface topography, maximizing contact area for uniform heat transfer.
- UL94 V-0 flame rating.
- 150°C RTI (Relative Thermal Index).
- Halogen free, RoHS compliant.
- Formulated for superior heat transfer characteristics.

Thermal Transfer Insulator Pad Fabric – Fiberglass core		
Property	Typical Value	Test Method
Color	Mauve or Gray	Visual Inspection
Thickness	7 to 20 mils / 0.18 – 0.51mm	ASTM D374
Construction	Supported	N/A
Supporting Material	Fiberglass	N/A
Hardness	77 Shore A	ASTM D2240
Tensile Strength	850 PSI / 5.9 MPa	ASTM D412
Elongation, machine direction	4%	ASTM D412
Elongation, 45 Warp and Fill	20%	ASTM D412
Thermal Conductivity	0.87 btu/(hr*ft°F) / 1.5 W/m-K	ASTM D5470
Thermal Impedance @ 40 PSI	0.3 in <sup>2</sup> * C/W / 1.9e <sup>-4</sup> m <sup>2</sup> * K/W	ASTM D5470
Glass Transition Temperature	-180F / -118C	ASTM D3418
Operating Range	-150 to 400F / -100 to 204C	N/A
Dielectric Strength, kVac	> 500 V/mil / > 19 kV/mm	ASTM D149
Flammability Rating	V-0	UL 94
RTI, Mechanical	300F / 150C	UL 746
RTI, Electrical	300F / 150C	UL 746
Hot Wire Ignition (HWI)	4 @ 7 mils / 3 @ 20 mils 4 @ 0.17mm / 3 @ 0.51mm	UL 746
High Current Arc Ignition (HAI)	3 @ 7 mils / 2 @ 20 mils 3 @ 0.17mm / 2 @ 0.51mm	UL746

<b>Thermal Transfer Insulator Pad Fabric – Kapton® core</b>		
<b>Property</b>	<b>Typical Value</b>	<b>Test Method</b>
Color	Mauve	Visual Inspection
Thickness	6 to 7.5 mils / 0.15 – 0.19mm	ASTM D374
Construction	Supported	N/A
Supporting Material	Kapton® MT, 1 mil	N/A
Hardness	77 Shore A	ASTM D2240
Elastic Modulus (< or = 1% strain)	38,900 PSI / 268 MPa	ABTG TMS A1
Shear Modulus (< or = 25% strain)	145 PSI / 1.0 MPa	ASTM D412
Elongation, 45 Warp and Fill	20%	ASTM D1002
Thermal Conductivity	0.87 btu/(hr*ft*F) / 1.5 W/m-K	ASTM D5470
Thermal Impedance @ 40 PSI	0.27 in <sup>2</sup> * C/W / 1.8e <sup>-4</sup> m <sup>2</sup> * K/W	ASTM D5470
Glass Transition Temperature	-180°F / -118°C	ASTM D3418
Operating Range	-150 to 400°F / -100 to 204°C	N/A
Dielectric Strength, kVac	➤ 1000 V/mil / > 39 kV/mm	ASTM D149
Flammability Rating	V-0	UL 94
RTI, Mechanical	300°F / 150°C	UL 746
RTI, Electrical	300°F / 150°C	UL 746
Hot Wire Ignition (HWI)	3	UL 746
High Current Arc Ignition (HAI)	2	UL746

<b>Thermal Transfer Insulator Pad Fabrics</b>			
<b>16” roll width – 125 yards roll length</b>			
<b>Custom die cutting service available</b>			
<b>Part Number</b>	<b>Thickness, in.</b>	<b>Substrate</b>	<b>Price per Roll</b>
F-FG-SR-4500-XX	.007 to .020	Fiberglass	\$ on request
F-KAP-SR-4500-XX	.006 to .0075	Kapton®	\$ on request

- The “XX” value is thickness measured in mils.

DuPont™ and Kapton® are trademarks or registered trademarks of the E.I. du Pont de Nemours Company

**Fiberglass Reinforced Silicone Rubber Sheet – AMS3320 & AMS3315**  
**500°F / 260°C: FlameShield™ - High Temperature, Heat & Flame Resistant**  
**Hot process protection**



- Used as a gasket material due to excellent dimensional stability.
- Resistant to weathering and engine oil.
- Thicknesses of .032", .062", .093", .125", & .250". 36" and 48" roll widths.
- Resistant to weld splatter, grinding sparks, solder drips, brazing.
- Tensile 1300 psi.
- Fibreglass layer: 20x18 weave. .014" thickness. 12.5 oz/yd<sup>2</sup>
- Meets AMS3320 & AMS3315 for baffle sealing.
- Rolls lengths vary during production – please call for availability.
- Available slit into tapes for engine baffle use or precision cut to size for round, square or special shape gaskets.

**FlameShield™ high temperature fiberglass reinforced silicone rubber sheet – Meets AMS3320 & AMS3315 Specifications**

Part Number	Durometer	Roll Width	Thickness in / mm	Price / linear yd
F-FGSR70-AMS-36-032-X	70	36"	1/32" / .032" / 0.79	\$ 126.10
F-FGSR70-AMS-36-062-X	70	36"	1/16" / .062" / 1.57	\$ 136.96
F-FGSR70-AMS-48-062-X	70	48"	1/16" / .062" / 1.57	\$ 195.96
F-FGSR70-AMS-36-093-X	70	36"	3/32" / .093" / 2.36	\$ 170.36
F-FGSR70-AMS-36-125-X	70	36"	1/8" / .125" / 3.18	\$ 225.46
F-FGSR70-AMS-48-125-X	70	48"	1/8" / .125" / 3.18	\$ 313.92
F-FGSR70-AMS-36-250-X	70	36"	1/4" / .250" / 6.35	\$ 457.50

- For the "X" value, specify length in yards.
- Minimum order is 2 yards

These materials can be easily used to make shields and covers that are assembled with mechanical fasteners. Easily punched or drilled for installation of grommets, or insertion of sheet metal screws or bolts.

Can be easily slit by hand with a straight edge and knife into tapes for fitting engine baffles by hand. Rolls can also be machine slit.

The edges of this material may be sealed with liquid silicone or paste in order to seal the fiber ends to prevent wicking of liquids or contamination. See our part numbers US-ESD (liquid silicone) and US-ESP (paste silicone).

## Fiberglass Fabric with Silicone Rubber Impregnation - Premium Grade -100°F to 450°F / -73°C to 232°C: High Temperature Heat & Chemical Resistance DeltaGlass™

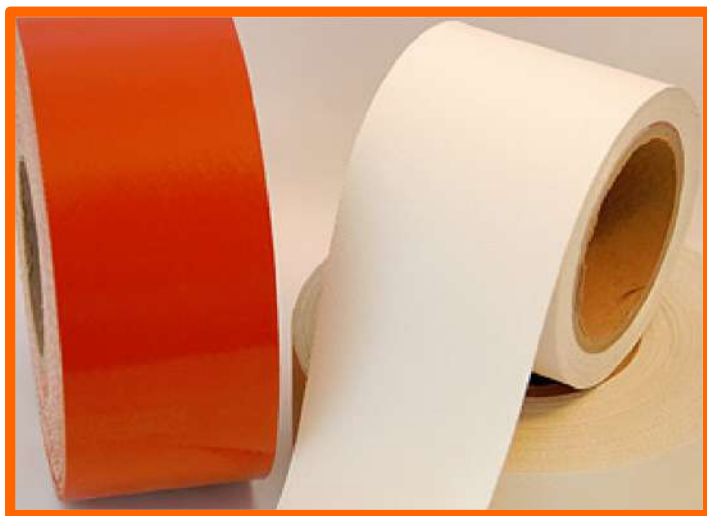

- e-fiberglass core.
- Silicone rubber coating.
- Excellent release properties.
- High dielectric factor.

This fabric offers higher temperature range with excellent resistance to almost all solvents, caustics and acids. Non-porous finish. Welding splatter, spark and molten splash resistant.

The base fabric is rated to 1200°F / 648°C.

Used as gaskets, safety curtains, conveyor belts. Rolls easily slit to specific widths to use as tapes.

450°F / 232°C continuous rating, high insulation value & excellent personnel protection

High Temperature, Heat & Chemical Resistance DeltaGlass™ E-glass Fiberglass Fabric with Silicone Rubber Coating – Premium Grade					
Part Number	Thickness, in.	Tensile warp lbs/in	Available width, in.	Weight oz/yd <sup>2</sup>	Price per linear yard
F-FG-SR2-P-009339-10-W	.0093	74	39	10	\$ 76.70 <sup>1</sup>
F-FG-SR2-P-015039-16-R/W	.0150	229	39	16	\$ 69.85 <sup>1</sup>
F-FG-SR2-P-020339-22-R	.0203	263	38	22	\$ 72.20 <sup>1</sup>
F-FG-SR2-P-022039-22-R/W	.0220	285	39	22	\$ 108.15 <sup>1</sup>
F-FG-SR1-P-023037.5-24-R*	.0230	350	37.5	24	\$ 102.17 <sup>1</sup>
F-FG-SR2-P-029539-32-R	.0295	286	39	32	\$ 130.93 <sup>2</sup>
F-FG-SR2-P-040039-41-W	.0400	410	39	41	\$ 137.73 <sup>2</sup>

- \* This fabric is coated with a saturation process that leave the reverse side fabric sealed but with no extra coverage over the base fabric.
- W at the end of the part number indicates white color. R indicates red color.
- Full roll lengths are available at 18 yards and 36 yards.
- <sup>1</sup> Minimum order for cut lengths is 2 yards. <sup>2</sup> Minimum order for cut lengths is 1 yards

**This Product is Available By-The-Yard: Discounts for full roll purchases**

**Fiberglass Fabric with Silicone Rubber Impregnation - Premium Grade**  
**FDA 21CFR177.1550 compliant for direct food contact**  
**-100°F to 350°F / -73°C to 176°C: High Temperature Heat & Chemical Resistance**  
**DeltaGlass™**

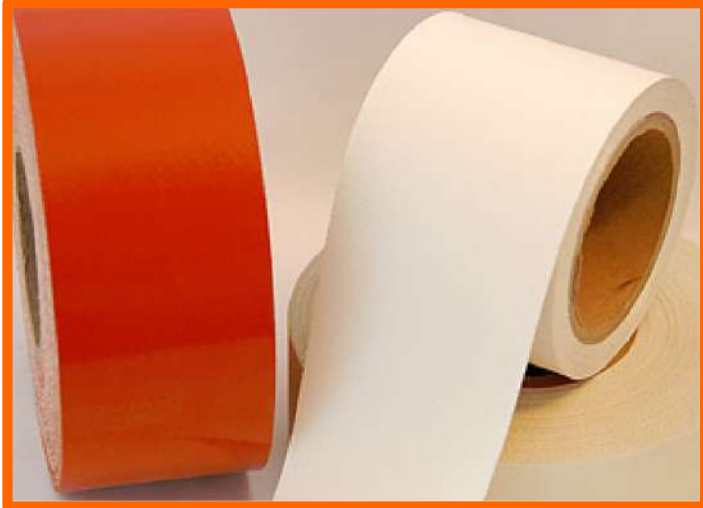

- e-fiberglass core
- silicone rubber coating both sides or PTFE one side and silicone rubber on the other side
- excellent release properties
- High dielectric factor

This fabric offers higher temperature range with excellent resistance to almost all solvents, caustics and acids. Non-porous finish.

The base fabric is rated to 1200°F / 648°C.

Used in food processing for baking and conveyor applications

450°F / 232°C continuous rating, high insulation value & excellent personnel protection

**High Temperature, Heat & Chemical Resistance DeltaGlass™**  
**E-glass Fiberglass Fabric with Silicone Rubber Coating – Premium Grade**  
**FDA complaint 21CFR177.1550 for direct food contact**

Part Number	Thickness, in.	Tensile warp lbs/in	Available width, in.	Weight oz/yd <sup>2</sup>	Price per Roll
F-FG-SR2-FDA-009339-10-W	.0095	155	38	12.6	\$ on request

**This Product is Available By-The-Yard: Discounts for full roll purchases**



## One Side Silicone Rubber Coated Fiberglass Cloth: Medium & Heavy Duty

**500°F / 260°C: FlameShield™ High Temperature, Heat & Flame Resistant  
 Molten Metal SplashGuard™ / Fire Blanket / Welding Blanket / Curtains-Shields**

- **Heavy Duty Coated One Side: Available 50 oz/yd<sup>2</sup> and 98 oz/yd<sup>2</sup>**
- **Molten Metal Splash, Welding Splatter & Grinding Spark Shields and Curtains**
- **Robotic welding arm and elbow covers & cable protectors**



Medium-Heavy Duty 50 oz/yd<sup>2</sup>.....  
 Coated 1 side



Heavy Duty 98 oz/yd<sup>2</sup>  
 Coated 1 side

500°F / 260°C continuous rating with weld splatter / molten metal splash protection.  
 2200°F / 1205°C for periods up to 15 minutes and short excursions to 3000°F / 1650°C.

<b>FlameShield™ 1 side coated high temperature fiberglass fabric</b>					
<b>Part Number</b>	<b>Weight Linear foot / oz/yd<sup>2</sup></b>	<b>Roll Width In / cm</b>	<b>Thickness In / mm</b>	<b>Price per Yard</b>	<b>Price per Metre</b>
F-FG-SR1-12540-98	2.20 lbs / 98	40 / 101	0.125 / 3.175	\$ 217.64	\$ 238.01
F-FG-SR1-06336-50*	1.10 lbs / 50	36 / 91	0.063 / 1.60	\$ 124.76	\$ 135.99

The color of this fabric is oxide-red

-98 is available in 25 yard rolls; -50 is available in 50 yard rolls

\* This material may be certified to MIL-I-24244 and meets NRC 1.36.

Heavy Duty 98 oz/yd<sup>2</sup> SplashGuard™ is an extreme duty fabric often fabricated into sleeves or other forms to protect hoses, cables and equipment from extreme industrial environments. Can be used to drape over moulds and forms during liquid metal pouring operations to slow the cooling rate of the ingot. Excellent molten metal splash protection.

Heavy Duty 50 oz/yd<sup>2</sup> and other lighter fabrics and 2 side coated fabrics are used as high temperature curtains and shields, weld splatter and pyro resistant sleeves and jackets, weather or spray-down / wash-down resistant high temperature fabric for making protective covers, sleeves, jackets. Very good molten metal splash protection.

All of these fabrics provide excellent cold temperature performance with flexibility to -76°C for refrigeration and cryogenic applications. These materials can be easily used to make shield and covers that are assembled with mechanical fasteners. Easily punched or drilled for installation of grommets, or insertion of sheet metal screws or bolts.

For applications requiring better anti-fray characteristics than the F-FG-SR1-12540-98 product, consider using F-FG-SR2-12540-92; which is a two sided version of the same base fabric; providing full molten splash protection at a slightly reduced weight but with superior anti-fray due to the two sided coating.

See website for more detailed photos of these fabrics.

**This Product is Available By-The-Yard / Metre: Discounts for full roll purchases  
 Custom Slitting to Any Width Available**

**Two Side Coated Silicone Rubber Fiberglass Cloth:**  
**Light Duty / Medium Duty / Heavy Duty**  
**500°F / 260°C: FlameShield™ High Temperature, Heat & Flame Resistant**  
**Molten Metal SplashGuard™ / Fire Blanket / Welding Blanket / Curtains-Shields**



500°F / 260°C continuous rating with weld splatter / molten metal splash protection.  
 (700°F / 260°C for 100 hours results in strength loss of 50%)  
 2200°F / 1205°C for periods up to 15 minutes and short excursions to 3000°F / 1650°C.

<b>FlameShield™ 2 side silicone rubber coated high temperature fiberglass fabrics</b>					
<b>Light Duty</b>					
<b>Part Number</b>	<b>Weight oz/yd<sup>2</sup></b>	<b>Roll Width In / cm</b>	<b>Thickness In / mm</b>	<b>Price per Yard</b>	<b>Price per Metre</b>
<b>TextureCoat™ Fabrics: Consistent coating thickness with light texture finish</b>					
F-FG-SR2L-0960-8.5-SG	8.5	60 / 152	0.009 / 0.23	\$ 28.33	\$ 30.88
F-FG-SR2L-1460-15-SG	15	60 / 152	0.014 / 0.36	\$ 34.16	\$ 37.24
F-FG-SR2L-1560-18-SG	18	60 / 152	0.015 / 0.38	\$ 26.28	\$ 28.65
F-FG-SR2L-1560-18-OR	18	60 / 152	0.015 / 0.38	\$ 26.28	\$ 28.65

COLORS: OR = Oxide-Red / SG = Silver Grey. Other colors may available or custom fabricated.  
 Available in lengths up to 150 feet / 50 Yards / 45 Metres.

<b>FlameShield™ 2 side silicone rubber coated high temperature fiberglass fabrics Medium Duty</b>					
<b>Part Number</b>	<b>Weight oz/yd<sup>2</sup></b>	<b>Roll Width In / cm</b>	<b>Thickness In / mm</b>	<b>Price per Yard</b>	<b>Price per Metre</b>
<b>TextureCoat™ Fabrics: Consistent coating thickness with texture finish</b>					
F-FG-SR2M-1760-18-OR	18	60 / 152	0.018 / 0.43	\$ 38.61	\$ 42.09
F-FG-SR2M-1760-18-SG	18	60 / 152	0.018 / 0.43	\$ 38.61	\$ 42.09
F-FG-SR2M-1960-26-SG	26	60 / 152	0.019 / 0.46	\$ 61.94	\$ 67.51

COLORS: OR = Oxide-Red / SG = Silver Grey. Other colors may available or custom fabricated.  
 Available in lengths up to 150 feet / 50 Yards / 45 Metres.

**F-FG-SR2M-1760-18-OR/SG** is designed to meet the rigid requirements of aviation and nuclear applications. Meets UL214 / NFPA-701, NRC Guide 1.36 and MIL-I-24244. Tensile strength 325 lbs/inch warp minimum / 250 lbs/inch fill minimum (ASTM-D-5035); tear strength 60 lbs min warp and fill (ASTM-D-5587); burst strength 600 psi minimum (ASTM-D-3786); flame resistance char length 1/16" max, afterglow 1 second max, flame out 1 second max (ASTM D-6413 & FED 191/5903.2). Weight and thickness as per ASTM-D-3776 & ASTM-D-1777.

<b>FlameShield™ 2 side silicone rubber coated high temperature fiberglass fabrics Heavy Duty</b>					
<b>Part Number</b>	<b>Weight oz/yd<sup>2</sup></b>	<b>Roll Width In / cm</b>	<b>Thickness In / mm</b>	<b>Price per Yard</b>	<b>Price per Metre</b>
<b>TextureCoat™ Fabrics: Consistent coating thickness with texture finish</b>					
F-FG-SR2H-3260-32-SG	32	60 / 152	0.032 / 0.81	\$ 108.16	\$ 117.89
F-FG-SR2H-3260-32-OR	32	60 / 152	0.032 / 0.81	\$ 108.16	\$ 117.89
<b>ContourCoat™ Fabrics: Contour coating providing full protection while reducing total weight Excellent Molten Metal Splash Protection but better anti-fray compared to SR1 fabrics (previous page)</b>					
F-FG-SR2H-6040-45-OR *	45	40 / 101	0.060 / 1.52	\$ 198.61	\$ 217.20
F-FG-SR2H-6060-45-OR *	45	60 / 152	0.060 / 1.52	\$ 217.34	\$ 237.68
F-FG-SR2H-7040-65-OR *	65	40 / 101	0.070 / 1.77	\$ 205.77	\$ 225.03
F-FG-SR2H-7060-65-OR *	65	60 / 152	0.070 / 1.77	\$ 225.55	\$ 246.66
F-FG-SR2H-12540-92-OR *	96	40 / 101	0.125 / 3.175	\$ 277.33	\$ 303.29

COLORS: OR = Oxide-Red / SG = Silver Grey. Other colors may available or custom fabricated.  
 Available in lengths up to 150 feet / 50 Yards / 45 Metres. \*Available in 25 yard rolls; other colors also available.

These fabrics are used to fabricate sleeves and other shapes to protect hoses, cables and equipment from extreme industrial environments. Can be used to drape over moulds and forms during liquid metal pouring operations to slow the cooling rate of the ingot. Other lighter fabrics are used as high temperature curtains and shields, weld splatter and pyro resistant sleeves and jackets, weather or spray-down / wash-down resistant high temperature fabric for making protective covers, sleeves, jackets, expansion joints. All of these fabrics provide excellent cold temperature performance with flexibility to -76°C for refrigeration and cryogenic applications. Flame Resistance: All fabrics provide 1 second maximum Flame Out and Afterglow; test method FED 191/5903.2.

**These fabrics are available By-The-Yard / Metre: Discounts for full roll purchases  
 Custom Slitting To Any Width is Available**

## Heat Reflecting Silicone Rubber Sealed Fiberglass Fabric 500°F / 260°C: Dual-Coat™ Aluminum Film One Side / Silicone Rubber One Side High Temperature & Radiant Heat Reflecting with Vapor Barrier



- Heat reflecting side is aluminum film. Perfect for applications involving movement or flexing, such as for bellows construction.
- Protection from intense radiant heat up to 3000°F.
- Reflects more than 95% of the radiant heat that contacts its surface.
- Silicone Rubber side provides excellent vapor barrier and protection from lubricating oils, wash down, contamination, etc.

### Additional Technical Data

Tensile Strength:	Warp: 200 lbs/inch 35.72 kg/cm Fill: 200 lbs/inch 35.72 kg/cm
Tear Strength:	Warp: 20 lbs 9.07 kg Fill: 20 lbs 9.07 kg
Burst Strength:	450 psi / 31.5 kg/cm <sup>2</sup>
Flame Resistance:	Char length 1" max Afterglow 20 seconds max Flame Out 10 seconds max

Dual-Coat™ Radiant Heat Reflective Protection Fabric Aluminum Film One Side / Silicone Rubber One Side				
Part Number	Weight oz/yd <sup>2</sup> / g/m <sup>2</sup>	Thickness in / mm	Roll width in / mm	Price per Linear Yard
F-FG-ALM-SR-1750-17	17 / 578	.017 / .432	50 / 1270	\$ 86.33

- Full rolls are 50 yards / 150 feet / 45.7 metres long
- This Product is Available By-The-Yard
- Discounts for full roll purchases
- Available as a tape - custom slitting to any width is available



## White Rubber Coated Fiberglass Universal Gasket Fabric (tacky cloth)

*With or Without Wire Insert*

**550°F / 287°C: Tuff-Flex™ High Temperature Heat Resistant**



This is a widely used and universal fabric for making gaskets, especially where a rough or uneven surface or flange exists. The fabric is a fiberglass base with a special white rubber formulation. The fabric is tacky, and has a plastic film surface covering that is removed before installation. The fabric will stick to itself once the film is removed.

To prevent sticking, a dusted 2-side version of the fabric is available.

For added lubrication, higher contact temperature workability a graphite coated version is available.

To facilitate installation instructions for end users, (for non symmetrical gaskets, etc.) the fabric is available with a Red/Black side (graphite on the black side).

**Wire Inserted Version:** The fill (widthwise) yarn for this version of the fabric has a twisted brass wired formed with it, providing additional strength and electrical conductivity/shielding.



**White Rubber Coated Fiberglass Universal Gasket Fabric (tacky cloth) (Continued)  
With or Without Wire Insert**

**550°F / 287°C: Tuff-Flex™ High Temperature Heat Resistant**



550°F / 287°C continuous rating, excellent sealing properties as a gasket material

<b>Tuff-Flex™ High Temperature White Rubber Coated Fiberglass Universal Gasket Fabric (Tacky Cloth)</b>						
Part Number	Thickness in / mm	Feet / Metres per Roll	Price per Yard By Thickness: A / B / C / D			
			"A" Frictioned Tacky	"B" Dusted Both Sides	"C" Graphite Both Sides	"D" Red & Black
<b>Gasket Cloth with Wire Insert</b>						
F-FG-TC-W-06240-80-X	.0625 / 1.6	150 / 45	\$ 100.80	\$ 104.79	\$ 119.19	\$ 119.19
F-FG-TC-W-12540-160-X	.125 / 3.2	75 / 22	\$ 209.58	\$ 213.60	\$ 228.00	\$ 228.00
F-FG-TC-W-18740-240-X	.187 / 4.8	50 / 15	\$ 318.39	\$ 322.41	\$ 336.81	\$ 336.81
F-FG-TC-W-25040-320-X	.250 / 6.3	37.5 / 11	\$ 427.20	\$ 431.19	\$ 445.59	\$ 445.59
<b>Gasket Cloth Without Wire Insert</b>						
F-FG-TC-N-06240-80-X	.0625 / 1.6	150 / 45	\$ 82.80	\$ 92.55	\$ 101.40	\$ 101.40
F-FG-TC-N-12540-160-X	.125 / 3.2	75 / 22	\$ 172.11	\$ 173.55	\$ 190.68	\$ 190.68
F-FG-TC-N-18740-240-X	.187 / 4.8	50 / 15	\$ 258.12	\$ 260.34	\$ 276.69	\$ 276.69
F-FG-TC-N-25040-320-X	.250 / 6.3	37.5 / 11	\$ 344.19	\$ 347.16	\$ 362.73	\$ 362.73

- For the "X" value, Specify A, B, C or D in part number to correspond to the desired finish

Roll Width for all versions is 40"  
Material weight is 80 oz/yd<sup>2</sup> for .0625 / 160 oz/yd<sup>2</sup> for .125 / 240 oz/yd<sup>2</sup> for .187 / 320 oz/yd<sup>2</sup> for .250

**This Product is Available By-The-Yard: Discounts for full roll purchases**

Curing: It is recommended that this material be cured in situ. This material must be heated to a minimum of 300°F within 60 minutes, then it must sit at 300°F or higher for 90 minutes for the rubber to fully cure.

Do not overtorque the material during this curing time or the rubber will be squeezed off of the base material.

If the material is not fully cured, the rubber will drip from the material causing voids. After curing the material can be exposed to a lower operational temperature.

## Fiberglass Fabric with Soft PTFE Coating Gasket Fabric 550°F / 287°C: High Temperature Heat & Chemical Resistance



Fiberglass base fabric with soft PTFE Coating

This fabric offers the advantage of a non-asbestos material with higher temperature range and with excellent resistance to almost all solvents, caustics and acids.

The base fabric is rated to 1000°F / 537°C.

PTFE melting point is 620°F / 327°C.

This fabric is a dull white color.

Excellent gasket material for its conformability and sealing against gas and liquids.

### High Temperature, Heat & Chemical Resistance Fiberglass Fabric with soft PTFE Coating

Part Number	Weight oz/yd <sup>2</sup>	Roll Width In / cm	Thickness In / mm	Price per yard
F-FG-PT-6040-24N	24	40 / 101	.060 / 1.52	\$ 116.40
F-FG-PT-6060-24W	24	60 / 152	.060 / 1.52	\$ 216.00
F-FG-PT-6540-30N	30	40 / 101	.065 / 1.65	\$ 131.28
F-FG-PT-6560-30W	30	60 / 152	.065 / 1.65	\$ 266.40
F-FG-PT-7540-36N	36	40 / 101	.075 / 1.91	\$ 141.96
F-FG-PT-7540-36W	36	60 / 152	.075 / 1.91	\$ 228.24
F-FG-PT-9040-40N	40	40 / 101	.090 / 2.29	\$ 152.88
F-FG-PT-9060-40W	40	60 / 152	.090 / 2.29	\$ 271.92
F-FG-PT-12540-64N	64	40 / 101	.125 / 3.18	\$ 282.08
F-FG-PT-12560-64W	64	60 / 152	.125 / 3.18	\$ 470.40

Roll length is 50 yards / 45 Metres. Please call for pricing on fabric with PSA

Heavier weight fabric may be in 25 yard / 22.5 Metre roll lengths

Example: 12560-64N is 177 pounds / 25 yard roll

#### This Product is Available By-The-Yard: Discounts for full roll purchases

The PTFE is applied to the rope by a proprietary sinterization process. The rope is soaked repeatedly in a PTFE dispersion, dried, and then baked. The result is a PTFE coating on the rope which is soft, robust and flexible; however, it can be abrasively removed from the rope with aggressive fingernail scraping, resulting in a thinner and thinner layer of ptfе remaining with each pass. The PTFE also causes the yarns to be sealed and the small gaps between the yarns filled, resulting in an almost air-tight / liquid-tight rope.

## Fiberglass Fabric with PTFE Resin Impregnation and Self Adhesive Backing - Premium Grade

550°F / 287°C: High Temperature Heat & Chemical Resistance DeltaGlass™



- PTFE Resin Impregnation.
- Silicone or Acrylic Adhesive with backing paper
- Roll width is 38". May be slit to narrower widths.

This fabric offers higher temperature range with excellent resistance to almost all solvents, caustics and acids. Very smooth and non-porous PTFE finish. High Temperature self adhesive backing with peel-off protection layer to reveal the adhesive. Will not cold flow under heavy loads.

The base fabric is rated to 1000°F / 537°C. PTFE melting point is 620°F / 327°C. Useable to -100F

Used in packaging as a release surface on heat sealers, blister and form-fill sealing equipment. Also used as a lining on guide rails, chutes and slides.

550°F / 287°C continuous rating for silicone adhesive version; 350°F / 176°C for acrylic version, high dielectric insulation value

High Temperature, Heat & Chemical Resistance DeltaGlass™ Fabric with PTFE Impregnation and Silicone Self Adhesive - Premium Grade				
550°F / 287°C continuous rating				
Part Number	Total Thickness incl adhesive, in.	Fabric with Coating Thickness, in.	Adhesion to steel oz/in	Price per Roll
F-FG-PTFE-RI-P-PSA-S-003039	.0052	.0030	40	\$ 2034.72
F-FG-PTFE-RI-P-PSA-S-005039	.0070	.0050	50	\$ 2859.12
F-FG-PTFE-RI-P-PSA-S-006039	.0080	.0060	50	\$ 3245.04
F-FG-PTFE-RI-P-PSA-S-010039	.0120	.0100	60	\$ 3818.16
Tensile Strength Warp / Fill (lbs/in)	Silicone: .003: 95 / 55. .005: 140 / 130. .006: 150 / 115. .010: 325 / 235			
Tear Strength Warp / Fill (lbs)	Silicone: .003: 1.5 / 0.9. .005: 2.2 / 1.7. .006: 2.1 / 1.8. .010: 7.5 / 4.0			

- Silicone Adhesive Thickness is .0022". Elongation at break is less than 5%.
- Roll length is 36 yards. 18 yard rolls are available at -30% of the price shown.
- Available in Industrial and Premium grades. Premium grade has an almost perfectly smooth surface while on Industrial grade the surface profile follows the weave pattern of the underlying base fabric.

**This Product is Available By-The-Yard: Discounts for full roll purchases**

**Fiberglass Fabric with PTFE Resin Impregnation and Self Adhesive Backing - Premium Grade (Continued)**  
**550°F / 287°C: High Temperature Heat & Chemical Resistance DeltaGlass™**



<b>High Temperature, Heat &amp; Chemical Resistance DeltaGlass™</b> <b>Fabric with PTFE Impregnation and Acrylic Self Adhesive - Premium Grade</b> 350°F / 176°C Continuous rating				
Part Number	Total Thickness incl adhesive, in.	Fabric with Coating Thickness, in.	Adhesion to steel oz/in	Price per Roll
F-FG-PTFE-RI-P-PSA-A-003039	.0050	.0030	45	\$ 1933.01
F-FG-PTFE-RI-P-PSA-A-005039-	.0072	.0051	60	\$ 2716.16
F-FG-PTFE-RI-P-PSA-A-006039	.0082	.0062	70	\$ 3082.78
F-FG-PTFE-RI-P-PSA-A-010039	.0120	.0100	80	\$ 3627.25
Tensile Strength Warp / Fill (lbs/in)	Acrylic: .003: 95 / 55. .005: 125 / 130. .006: 150 / 150. .010: 325 / 235			
Tear Strength Warp / Fill (lbs)	Acrylic: .003: 1.5 / 0.9. .005: 1.8 / 1.7. .006: 2.1 / 1.7. .010: 7.5 / 4.0			

- Elongation at break is less than 5%.
- Roll length is 36 yards. 18 yard rolls are available at -30% of the price shown.
- Available in Industrial and Premium grades. Premium grade has an almost perfectly smooth surface while on Industrial grade the surface profile follows the weave pattern of the underlying base fabric.

**This Product is Available By-The-Yard: Discounts for full roll purchases**

The PTFE resin is applied to the fabric in a hot process and under pressure, causing a total impregnation of the base fabric. The surface of the resin is smooth and it takes considerable and aggressive force to scratch the PTFE surface to remove it from the fabric with fingernail scraping.

## Fiberglass Fabric with PTFE Resin Impregnation and Self Adhesive Backing - Industrial Grade

### 550°F / 287°C: High Temperature Heat & Chemical Resistance DeltaGlass™



- PTFE Resin Impregnation.
- Silicone or Acrylic Adhesive with backing paper
- Roll width is 39". May be slit to narrower widths.

This fabric offers higher temperature range with excellent resistance to almost all solvents, caustics and acids. Very smooth and non-porous PTFE finish. High Temperature self adhesive backing with peel-off protection layer to reveal the adhesive. Will not cold flow under heavy loads.

The base fabric is rated to 1000°F / 537°C. PTFE melting point is 620°F / 327°C.

Used in packaging as a release surface on heat sealers, blister and form-fill sealing equipment. Also used as a lining on guide rails, chutes and slides.

550°F / 287°C continuous rating, high dielectric insulation value

High Temperature, Heat & Chemical Resistance DeltaGlass™ Fabric with PTFE Impregnation and Self Adhesive - Industrial				
Part Number	Total Thickness incl adhesive, in.	Fabric with Coating Thickness, in.	Adhesion to steel oz/in	Price per Roll
F-FG-PTRI-I-PSA-004739-X	.0047	.0030	45	\$ 1695.60
F-FG-PTRI-I-PSA-006739-X	.0067	.0050	55	\$ 2382.48
F-FG-PTRI-I-PSA-007739-X	.0077	.0060	55	\$ 2704.32
F-FG-PTRI-I-PSA-017739-X	.0177	.0100	60	\$ 3181.68
F-FG-PTRI-I-PSA-015739-X	.0157	.0140	65	\$ 4881.60
Tensile Strength Warp / Fill (lbs/in)	Silicone: .003: 100 / 50. .005: 135 / 120. .006: 150 / 140. .010: 325 / 235. .014: 440 / 250 Acrylic: .003: 90 / 50. .005: 135 / 120. .006: 150 / 140. .010: 250 / 155. .014: 440 / 250			
Tear Strength Warp / Fill (lbs)	Silicone: .003: 1.7 / 0.9. .005: 2.3 / 1.5. .006: 2.0 / 1.5. .010: 4.9 / 3.0. .014: 7.0 / 5.0 Acrylic: .003: 1.7 / 0.9. .005: 1.8 / 1.5. .006: 2.0 / 1.5. .010: 6.0 / 3.0. .014: 7.0 / 5.0			

- Adhesive Thickness is .0017 on all products. Elongation at break is less than 5%.
- Roll length is 36 yards. 18 yard rolls are available at -30% of the price shown.
- Available in Industrial and Premium grades. Premium grade has an almost perfectly smooth surface while on Industrial grade the surface profile follows the weave pattern of the underlying base fabric.
- For the "X" value specify "A" or "S" in the part number to correspond to the desired adhesive. A = Acrylic S = Silicone.

#### This Product is Available By-The-Yard: Discounts for full roll purchases

The PTFE resin is applied to the fabric in a hot process and under pressure, causing a total impregnation of the base fabric. The surface of the resin is smooth and it takes considerable and aggressive force to scratch the ptfе surface to remove it from the fabric with fingernail scraping.



**Fiberglass Fabric with PTFE Resin Impregnation**  
**FDA Compliant - 21CFR177.1550 for direct food contact**  
**500°F / 260°C: High Temperature Heat & Chemical Resistance DeltaGlass™**



- Meets FDA 21CFR177.1550 for direct food contact - popular for pan liners and conveyors for baking applications
- PTFE Resin Impregnation.
- May be slit to narrower widths.

This fabric offers higher temperature range with excellent resistance to almost all solvents, caustics and acids. Very smooth and non-porous PTFE finish.

The base fabric is rated to 1000°F / 537°C. PTFE melting point is 620°F / 327°C.

Used in packaging as a release surface on heat sealers, blister and form-fill sealing equipment. Also used as a lining on guide rails, chutes and slides.

**Fiberglass Fabric with PTFE Resin Impregnation (Continued)**  
**FDA Compliant - 21CFR177.1550 for direct food contact**  
**500°F / 260°C: High Temperature Heat & Chemical Resistance DeltaGlass™**



500°F / 260°C continuous rating

<b>High Temperature, Heat &amp; Chemical Resistance DeltaGlass™ Fabric with PTFE Impregnation – FDA Compliant</b>						
<b>Part Number</b>	<b>Overall Thickness, in.</b>	<b>Tensile warp/fill lbs/yd<sup>2</sup></b>	<b>Available width, in.</b>	<b>Weight oz/yd<sup>2</sup></b>	<b>Dielectric volts/mil</b>	<b>Price per sq/yd</b>
<b>Premium Grade – Superior fabric for pan liners and belts for food processing</b> Highest PTFE-to-substrate ratio / Superior release and extended life						
F-FG-PT-FDA-P-0029XX-4.2	.0029	105 / 75	38, 50, 60	4.2	1350	\$ 31.26
F-FG-PT-FDA-P-0049XX-8	.0049	170 / 160	40, 50, 60	8	1100	\$ 53.30
F-FG-PT-FDA-P-0060XX-9.4	.0060	175 / 160	40, 50, 60	9.4	1200	\$ 58.66
F-FG-PT-FDA-P-0095XX-16	.0095	325 / 180	37.5, 50	16	850	\$ 79.76
F-FG-PT-FDA-P-009560-16	.0095	325 / 180	60	16	850	\$ 102.36
F-FG-PT-FDA-P-010544-17	.0105	300 / 175	44	17	700	\$ 103.13
F-FG-PT-FDA-P-014037-23	.0140	450 / 275	37.5	23	550	\$ 140.70
F-FG-PT-FDA-P-0250110-32	.0250	410 / 600	110	32	225	\$ call
<b>Standard Grade – Release sheet applications for heat sealing &amp; laminating</b> Smooth surface with superior non-stick properties / economical						
F-FG-PT-FDA-S-0026XX-3.8	.0026	100 / 75	38, 50, 60	3.8	1350	\$ 29.43
F-FG-PT-FDA-S-003638-5.6	.0036	150 / 75	38	5.6	1450	\$ 54.01
F-FG-PT-FDA-S-0045XX-7	.0045	160 / 150	40, 50, 60	7	1000	\$ 47.93
F-FG-PT-FDA-S-0055XX-9	.0055	170 / 165	40, 50, 60	9	1200	\$55.23
F-FG-PT-FDA-S-0090XX-15	.0090	310 / 175	37.5, 50, 60	14.	810	\$ 77.10
F-FG-PT-FDA-S-013537-22	.0135	500 / 300	37	22	550	\$ 131.33
F-FG-PT-FDA-S-0245XX-28	.0245	425 / 500	110, 189	28	210	\$ call

- Roll length is 36 yards. 18 yard rolls are available at -30% of the price shown.
- For "XX", specify applicable roll width from table

**This Product is Available By-The-Yard: Discounts for full roll purchases**

The PTFE resin is applied to the fabric in a hot process and under pressure, causing a total impregnation of the base fabric. The surface of the resin is smooth and it takes considerable and aggressive force to scratch the PTFE surface to remove it from the fabric with fingernail scraping. The surface is smooth and does not take on any patterning from the substrate fabric.

**Fiberglass Fabric with PTFE Resin Impregnation – Black Color**  
**Also available as Anti-Static / Conductive**  
**500°F / 260°C: High Temperature Heat & Chemical Resistance DeltaGlass™**



This fabric  
is Black

- PTFE resin has been formulated for dark black color.
- PTFE Resin Impregnation.
- May be slit to narrower widths.
- Anti-Static – Conductive version with carbon additive.

This fabric offers higher temperature range with excellent resistance to almost all solvents, caustics and acids. Very smooth and non-porous PTFE finish.

The base fabric is rated to 1000°F / 537°C. PTFE melting point is 620°F / 327°C.

Used in packaging as a release surface on heat sealers, blister and form-fill sealing equipment. Also used as a lining on guide rails, chutes and slides.

**Fiberglass Fabric with PTFE Resin Impregnation - Black Color (continued)**  
**Also available as Anti-Static / Conductive**  
**500°F / 260°C: High Temperature Heat & Chemical Resistance DeltaGlass™**



500°F / 260°C continuous rating

<b>High Temperature, Heat &amp; Chemical Resistance DeltaGlass™</b> <b>Fabric with PTFE Impregnation and Black Resin Color</b> <b>Anti-Static / Conductive version available</b>						
Part Number	Overall Thickness, in.	Tensile warp/fill lbs/yd <sup>2</sup>	Available width, in.	Weight oz/yd <sup>2</sup>	Dielectric volts/mil	Price per sq/yd
<b>Premium Grade</b>						
F-FG-PT-BK-004638-7.2	.0046	170 / 150	38	7.2	800	\$ 51.80
F-FG-PT-BK-005637-8.8	.0056	180 / 170	37.5	8.8	550	\$ 54.16
F-FG-PT-BK-0090XX-16	.0090	300 / 190	37.5, 50	14.5	350	\$ 94.63
F-FG-PT-BK-014080-22	.0250	425 / 325	80	21.7	180	\$ call
<b>Premium Grade – With Anti-Static / Conductive additive</b>						
F-FG-PT-AS-0090XX-15	.0090	285 / 190	37.5, 50, 60	14.5	N/A	\$ 94.63
F-FG-PT-AS-014060-21	.0140	475 / 350	60	21	N/A	\$ 129.50

- Roll length is 36 yards. 18 yard rolls are available at -30% of the price shown.
- For "XX", specify applicable roll width from table

**This Product is Available By-The-Yard: Discounts for full roll purchases**

The PTFE resin is applied to the fabric in a hot process and under pressure, causing a total impregnation of the base fabric. The surface of the resin is smooth and it takes considerable and aggressive force to scratch the PTFE surface to remove it from the fabric with fingernail scraping. The surface is smooth and does not take on any patterning from the substrate fabric.

**Very High Temperature & Heat Resistant Fiberglass Cloth Fabric:**  
**Premium Grade**  
**1200°F / 648°C: DeltaGlass™**



- Manufactured of fiberglass yarns, has a 1200°F / 648°C continuous rating while providing high insulation value & excellent personnel protection.
- Good abrasion resistance and tensile strength. Filament and Texturized versions available.
- A high-performance very high temperature fabric, used in almost all industries for heat protection.
- Also available with coatings such as Vermiculite, PTFE, Aluminum foil/film, Neoprene/Latex. Also available with wire insert.



**Very High Temperature & Heat Resistant Fiberglass Cloth Fabric: *Premium Grade***  
**1200°F / 648°C: DeltaGlass™**

1200°F / 648°C continuous rating, high insulation value & excellent personnel protection

<b>DeltaGlass™ Very High Temperature &amp; Heat Resistant Plain Cloth Roll Fabric – Premium Grade</b>				
<b>Part Number</b>	<b>Weight oz/yd<sup>2</sup></b>	<b>Roll Width In / cm</b>	<b>Thickness In / mm</b>	<b>Price per Yard / Metre</b>
F-FG-P-0760-6	6	60 / 152	.007 / .18	\$ 13.77 / \$ 15.06
F-FG-P-0960-9	9	60 / 152	.009 / .23	\$ 22.47 / \$ 24.49
F-FG-P-6040-24	24	40 / 101	.060 / 1.52	\$ 26.85 / \$ 29.27
F-FG-P-6060-24	24	60 / 152	.060 / 1.52	\$ 37.23 / \$ 40.58
F-FG-P-6540-30	30	40 / 101	.065 / 1.65	\$ 30.18 / \$ 32.90
F-FG-P-6560-30 **	30	60 / 152	.065 / 1.65	\$ 42.36 / \$ 46.17
F-FG-P-7540-36	36	40 / 101	.075 / 1.91	\$ 32.64 / \$ 35.58
F-FG-P-7560-36	36	60 / 152	.075 / 1.91	\$ 60.60 / \$ 66.05
F-FG-P-9040-40	40	40 / 101	.090 / 2.29	\$ 35.16 / \$ 38.32
F-FG-P-9060-40	40	60 / 152	.090 / 2.29	\$ 62.52 / \$ 68.15
F-FG-P-12540-64	64	40 / 101	.125 / 3.18	\$ 71.32 / \$ 77.74
F-FG-P-12560-64 #	64	60 / 152	.125 / 3.18	\$ 117.60 / \$ 128.18
F-FG-P-25060-100	100	60 / 152	.250 / 6.36	call

Roll length is 150 Feet / 50 yards / 45 Metres. Please call for pricing on fabric with PSA

**\*\* Note: This fabric has MSHA-BC-109 Approval and is Marked as such.**

\* Note: On fabrics with PSA, the PSA will burn off at temperatures above 400°F and should be used only to facilitate installation. Material with PSA should not be used in confined areas at elevated temperatures without ventilation until all of the PSA has vaporized.

**These Products are Available By-The-Yard / Metre: Discounts for full roll purchases**



**Heat Treated Fiberglass Cloth Fabric: Premium Grade**  
**1200°F / 648°C: DeltaGlass™ Very High Temperature & Heat Resistant**



- Manufactured of fiberglass yarns, has a 1200°F / 648°C continuous rating while providing high insulation value & excellent personnel protection.
- Good abrasion resistance and tensile strength.
- Heat Treated fabrics have impurities removed, resulting in a very clean fabric which meets marine requirements.
- Meets MIL-C-20079 Type I, Class 9
- PN F-FG-P-HT-1860-8.5 Meets MIL-C-20079 Type I, Class 3
- Designed for shipboard/marine lagging and as a jacketing material for use over insulation.
- Designed to replace asbestos materials grades UG, AA, AAA and AAA-M on turbine blankets, fittings. Flange covers, engine exhaust pipes and pipe and duct lagging.
- Available red dyed to comply with Federal Standard 595A color chip 31158.

1200°F / 648°C continuous rating, high insulation value & excellent personnel protection

<b>DeltaGlass™ Very High Temperature &amp; Heat Resistant Heat Treated Cloth Roll Fabric</b> <b>Meets USCG 164.009, MIL-C-20079F Type 1, Class 3 &amp; MIL-I-24244B</b>				
Part Number	Weight oz/yd <sup>2</sup>	Roll Width In / cm	Thickness In / mm	Price per Yard / Metre
F-FG-P-HT-1860-8.5	8.5	60 / 152	.018 / .457	\$ 17.43 / \$ 19.07
F-FG-P-HT-3240-18	18	40 / 101	.032 / .81	\$ 20.16 / \$ 21.97
F-FG-P-HT-3260-18	18	60 / 152	.032 / .81	\$ 26.24 / \$ 28.60

Roll length is 150 Feet / 50 yards / 45 Metres. Please call for pricing on fabric with PSA

**These Products are Available By-The-Yard / Metre: Discounts for full roll purchases**

**Weld Splatter Shield Fiberglass Cloth Fabric: Premium Grade**  
**1100°F / 593°C: DeltaGlass™ Very High Temperature & Heat Resistant**



- Manufactured of fiberglass yarns, has a 1100°F / 593°C continuous rating while providing high insulation value & excellent personnel protection.
- Good abrasion resistance and tensile strength.
- A neoprene/latex coating provides good weld splatter resistance.
- Can be easily cut to shape and has very good fray resistance.
- Due to the coating, this fabric has a stiffness similar to thick bristol board or a thinner cardboard, allowing it to be placed into temporary positions with its inherent stiffness holding it in place – good for applications such as assembly line brazing, or as an easy installed and removed protection shield for plumbing/welding.

1100°F / 593°C continuous rating, high insulation value & excellent personnel protection

<b>DeltaGlass™ Very High Temperature &amp; Heat Resistant Weld Splatter Shield Cloth Roll Fabric</b>				
<b>Part Number</b>	<b>Weight oz/yd<sup>2</sup></b>	<b>Roll Width In / cm</b>	<b>Thickness In / mm</b>	<b>Price per Yard / Metre</b>
F-FG-WS-3040-24	24	40 / 101	.030 / .79	\$ 22.53 / \$ 24.56
F-FG-WS-3060-24	24	60 / 152	.030 / .79	\$ 31.83 / \$ 34.69

Roll length is 150 Feet / 50 yards / 45 Metres. Please call for pricing on fabric with PSA

**These Products are Available By-The-Yard / Metre: Discounts for full roll purchases**

**HH-P-31F Wire Reinforced Fiberglass - Asbestos Replacement Fabric:  
 1200°F / 648°C: DeltaGlass™ Very High Temperature & Heat Resistant Fiberglass  
 Fabric with Stainless Steel Wire Insert**



Fig 1 – Fabric Roll

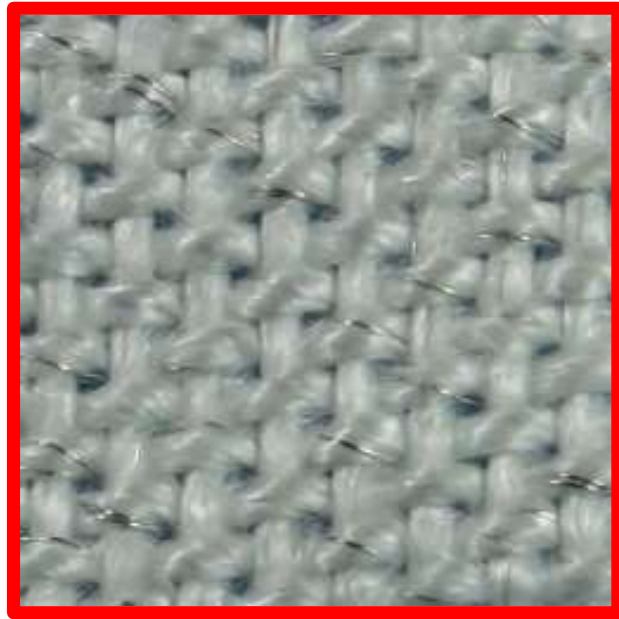

Figure 2 – Close up view

- Meets HHP31 F TY1
- Certification upon request

This texturized fabric is strengthened with an interwoven stainless steel wire which accounts for 10% of the fabric's weight. Weave is a 1x1 Plain, 20 Ends x14 Picks. Each yarn is composed of 3 fiberglass filaments, interwoven with 2 wires, each 304 Stainless Steel (.0045" diameter), all twisted together. This provides a very dense and strong very high temperature wire mesh / fiberglass fabric with excellent tensile strength of 225 lbs Warp and 125 lbs Fill.

Used extensively as a gasket material for its reinforcement and high strength. This fabric can also be used to build complex covers and shields for equipment panels, providing high EMI/RFI shielding. Also used for large stage proscenium fire-curtains due to the high strength of this fabric. This fabric replaces asbestos versions of HHP-31-TY 1, such as NSN 5330-00-027-2535

<b>DeltaGlass™ Very High Temperature &amp; Heat Resistant HHP-31 Asbestos Replacement Fabric</b>				
<b>Part Number</b>	<b>Weight oz/yd<sup>2</sup> g/m<sup>2</sup></b>	<b>Roll Width In / cm</b>	<b>Thickness In / mm</b>	<b>Price per Yard / Metre</b>
F-FG-HHP31-4560-24	24 oz/yd <sup>2</sup> 814 g/m <sup>2</sup>	60 / 152	.045 / 1.14	\$ 146.28 / \$ 159.45

Roll length is 150 Feet / 50 Yards / 45 Metres. Please call for pricing on fabric with PSA



## Fiberglass Fabrics with Wire Inserts 1200°F / 648°C: SteelTex™ Very High Temperature & Heat Resistant



- Reinforced fabrics offer dimensional stability and additional support for fabrications such as expansion joints. The wire also dissipates hot spots.
- Insert wire is .0045" diameter 321 stainless.
- Additional surface treatments have been added to extend the temperature range of the base fabric.
- Version 6560-365 meets: ASTM D6413: Vertical Flame Resistance, ASTM E-84: Surface Flame Spread & Smoke Density Testing, ASTM F955: Molten Metal Splash Testing, FAR 25, Appendix F, Part III & IV: Flame Penetration Resistance & Smoke Density Testing, BSS 7239: Toxicity of Products Combustion Testing. Minimum quantity run may apply.

SteelTex™ Very High Temperature & Heat Resistant Fabric with Reinforcement Wire				
Part Number	Weight oz/yd <sup>2</sup>	Roll Width In / cm	Thickness In / mm	Price per linear Yard / Metre
F-FG-WI-2550-18	18	50 / 127	.025 / .635	call
F-FG-WI-4560-24	24	60 / 152	.045 / 1.14	\$ 128.28 / \$ 140.25
F-FG-WI-5360-24	26	60 / 152	.053 / 1.35	\$ 169.60 / \$ 185.43
F-FG-WI-7560-34	34	60 / 152	.075 / 1.90	\$ 128.40 / \$ 140.38
F-FG-WI-7560-35	35	60 / 152	.075 / 1.90	\$ 142.33 / \$ 155.62
F-FG-WI-6560-365*	36.5	60 / 152	.065 / 1.65	\$ 185.27 / \$ 202.56
F-FG-WI-7260-39**	39	60 / 152	.072 / 1.83	\$ 153.20 / \$ 167.50
F-FG-WI-7360-40	40	60 / 152	.073 / 1.85	\$ 198.47 / \$ 216.99

4560-24 has 2 wires per yarn, both warp and weft directions.

7560-34 has 2 wires per yarn in the weft and 2 wires per yarn every other yarn in the warp.

7560-35 has 2 wires per yarn in the weft and 2 wires per yarn every other yarn in the warp plus an additional binder for enhanced handling

\*6560-365 has 2 wires per yarn, both warp and weft directions plus an additional coating for superior fire and smoke containment: meets: ASTM D6413: Vertical Flame Resistance, ASTM E-84: Surface Flame Spread & Smoke Density Testing, ASTM F955: Molten Metal Splash Testing, FAR 25, Appendix F, Part III & IV: Flame Penetration Resistance & Smoke Density Testing, BSS 7239: Toxicity of Products Combustion Testing. Minimum orders may apply.

\*\*7260-39 has 2 wires per yarn in the weft and 2 wires per yarn every other yarn in the warp, plus an additional aluminized acrylic binder for heat reflection and good weld spark and splatter protection.

Roll length is 150 Feet / 50 Yards / 45 Metres. Some products may be available by-the-yard.

Please call for pricing on fabric with PSA



**FAA Fiberglass Fabrics**  
**1200°F / 648°C: SteelTex™ Very High Temperature & Heat Resistant**



- Reinforced fabrics offer dimensional stability and additional support for fabrications such as expansion joints. The wire also dissipates hot spots.
- Insert wire is .0045" diameter 321 stainless.
- Additional surface treatments have been added to extend the temperature range of the base fabric.
- Meets:
  - ASTM D6413: Vertical Flame Resistance,
  - ASTM E-84: Surface Flame Spread & Smoke Density Testing,
  - ASTM F955: Molten Metal Splash Testing,
  - FAR 25, Appendix F, Part III & IV: Flame Penetration Resistance & Smoke Density Testing,
  - BSS 7239: Toxicity of Products Combustion Testing.
- Minimum quantity run may apply.

<b>FAA Very High Temperature &amp; Heat Resistant Fabric with Reinforcement Wire</b>				
<b>Part Number</b>	<b>Weight oz/yd<sup>2</sup></b>	<b>Roll Width In / cm</b>	<b>Thickness In / mm</b>	<b>Price per linear Yard / Metre</b>
F-FG-WI-FAA-6560-365*	36.5	60 / 152	.065 / 1.65	\$ 185.27 / \$ 202.56

Has 2 wires per yarn, both warp and weft directions plus an additional coating for superior fire and smoke containment.

This product is used to fabricate specialized pallet covers and container coverings and curtains. Also used to make bags for containment of electronic items with high energy battery systems, lithium batteries, etc.

Roll length is 150 Feet / 50 Yards / 45 Metres. Some products may be available by-the-yard.

Please call for pricing on fabric with PSA

## Aluminum Film Coated Aramid Fabric / Cloth

### 750°F / 399°C: AraMax™ Poly-Layered High Temperature & Radiant Heat Reflecting

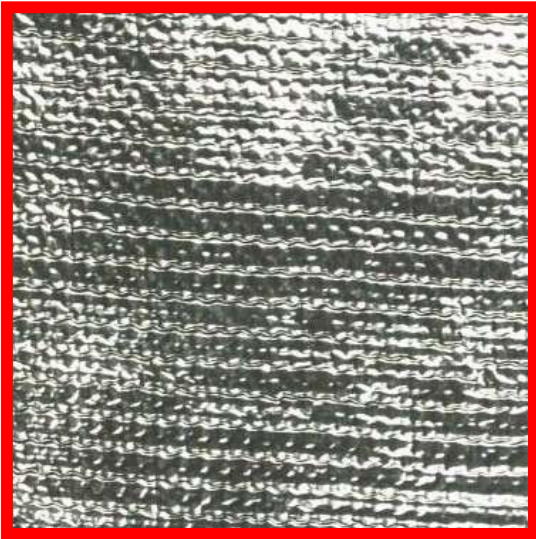

- Radiant heat reflecting fabrics based on a poly-layered aluminum film structure laminated to aramid base substrates. Excellent long-term flexibility.
- Protection from intense radiant heat up to 3000°F.
- Reflects more than 95% of the radiant heat that contacts its surface.
- Spun and Core Spun Aramid base materials.
- Excellent radiant heat protection from sources such as super-hot metal slabs, proximity to liquid metal, infrared heaters, open flame / plasma or engine exhaust manifolds is a concern.
- Suitable for work wear fabrication.

Poly-layered AraMax™ fabric offers protection when radiant heat from infrared sources such as super-hot metal slabs, proximity to liquid metal, open flame/plasma or engine exhaust manifolds is a concern. Constructed from a high-temperature aramid fiber base fabric which is then coated with heat reflective poly-layered aluminum film. The base fabric is rated to 750°F / 399°C while the radiant capability if the fabric is 3000°F.

<b>AraMax™ Poly-Layered Aluminized Film on Aramid Fabric Radiant Heat Reflective Protection</b>				
<b>Part Number</b>	<b>Weight oz/yd<sup>2</sup> / g/sq m</b>	<b>Thickness in / mm</b>	<b>Roll width in / mm</b>	<b>Price Linear Yard</b>
F-AK-ALM-2360-10 (twill 50x44 spun)	10 / 340	.023 / 0.60	60 / 1524	\$ 144.70
F-AK-ALM-5740-19 (plain x core spun )	19 / 645	.057 / 1.45	40 / 1016	\$ 77.22
F-AK-ALM-6340-24 (plain 21x12 core spun)	24 / 746	.063 / 1.63	40 / 1016	\$ 89.66

- **Full rolls are 50 yards / 150 feet / 45.7 metres long**
- **This Product is also available By-The-Yard**
- **Discounts apply at 10 yards and full roll purchases**



**Aluminum Foil Coated High Temperature & Radiant Heat Reflective Fabric / Cloth: MIL Spec & Standard**  
**300°F / 149°C DeltaGlass™ Continuous Standard Grade and 500°F / 260°C Continuous (600°F / 315°C Intermittent) High Temperature Grade**



- Base material is partially heat treated to remove organics, set the weave dimensionally and reduce fray and loose fibers.
- Meets USCG 164.009 due to low adhesive content.
- Protection from radiant heat. One side is coated with a 1 mil (.001") thickness aluminum foil. Reflects more than 95% of the radiant heat that contacts its surface. Excellent radiant heat protection from sources such as super-hot metal slabs, proximity to liquid metal, infrared heaters, open flame / plasma or engine exhaust manifolds.
- Available in two temperature ratings based on type of laminating adhesive.
- Used in Marine and nuclear applications as a flange shield material due to its excellent vapor barrier and water/oil resistance.

**Meets MIL-C-20079G Type 1 Class 10**  
**Meets MIL-I-24244B / USCG 164.009 / NRC Guide 1.36**

The aluminum coating melts at 1220°F / 660°C, however it does take some time for the aluminum to absorb enough heat to melt – thereby it can withstand short exposure to higher temperatures. The base fabric has a rating of 1000°F continuous and higher short term exposure. **For applications not requiring the MIL spec material, our most popular Standard grade aluminized fabric is highlighted in yellow in the table below.**

<b>DeltaGlass™ Mil Spec Aluminized Radiant Heat Reflective Protection Fabric</b>				
<b>Part Number</b>	<b>Weight oz/yd<sup>2</sup></b>	<b>Thickness in inches</b>	<b>Roll width in inches</b>	<b>Price per Linear Yard</b>
DeltaGlass Aluminum Foil Coated Fiberglass MIL Spec 500°F / 260°C				
F-FG-AL-MIL-HT-2660-20	19.5	.026	60	\$ 57.64
DeltaGlass Aluminum Foil Coated Fiberglass Standard Grade: 1 yard minimum				
F-FG-AL-RHR-3060-21	21	.030	60	\$ 47.07
F-FG-AL-RHR-6040-35	35	.060	40	\$ 35.88
F-FG-AL-RHRHD-7560-42*	42	.075	60	\$ 66.71

- Full rolls are 50 yards / 150 feet / 45.7 metres long. Minimum purchase for MIL spec is 15 yards.
- \* HD fabric has 3mil thick aluminum foil: our heaviest heat reflective fabric
- PSA adhesive on the back side is available by special order

## Aluminized PET Film Coated Fiberglass Fabric / Cloth 1000°F / 537°C: AluMax™ Poly-Layered High Temperature & Radiant Heat Reflecting

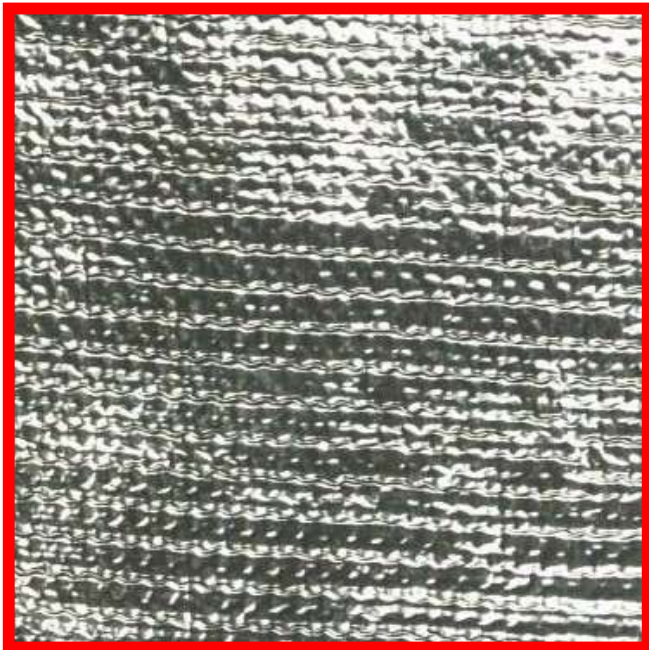

- Comprehensive line of radiant heat reflecting fabrics based on a poly-layered alu structure laminated to fiberglass base substrates. Excellent long-term flexibility.
- Protection from intense radiant heat up to 3000°F.
- Reflects more than 95% of the radiant heat that contacts its surface.
- 3 filament and 3 texturized base materials.
- Excellent radiant heat protection from sources such as super-hot metal slabs, proximity to liquid metal, infrared heaters, open flame / plasma or engine exhaust manifolds is a concern.
- Suitable for workwear fabrication with or without liner materials.

Poly-layered AluMax™ fabric offers protection when radiant heat from infrared sources such as super-hot metal slabs, proximity to liquid metal, open flame/plasma or engine exhaust manifolds is a concern. Constructed from a high-temperature base fabric which is then coated with heat reflective poly-layered aluminum. The base fabric is rated to 1000°F while the radiant capability of the fabric is 3000°F.

<b>AluMax™ Poly-Layered Aluminized Film Radiant Heat Reflective Protection Fabric</b>				
<b>Part Number</b>	<b>Weight oz/yd<sup>2</sup></b>	<b>Thickness in inches</b>	<b>Roll width in inches</b>	<b>Price per Linear Yard</b>
Filament Fiberglass Base (plain & satin weave)				
F-FG-ALM-0960-8 (plain weave)	8	.009	60	\$ 56.70
F-FG-ALM-0860-11 (satin weave)	11	.008	60	\$ 61.96
F-FG-ALM-1760-15 (satin weave)	15	.017	60	\$ 62.30
Texturized Fiberglass Base (plain weave)				
F-FG-ALM-2560-12.5 (plain weave)	12.5	.025	60	\$ 49.40
F-FG-ALM-4060-22 (plain weave)	22	.040	60	\$ 52.19
F-FG-ALM-6040-26 (plain weave)	26	.060	40	\$ 57.07

- Full rolls are 50 yards / 150 feet / 45.7 metres long
- This Product is Available By-The-Yard Except Where Indicated
- Discounts for full roll purchases
- PSA adhesive coated on the back side is available





## Aluminum Film Coated Fabric Cloth for Protective Clothing Fabrication 750°F / 398°C to 1000°F / 537°C: AluMax™ Poly-Layered High Temperature & Radiant Heat Reflecting

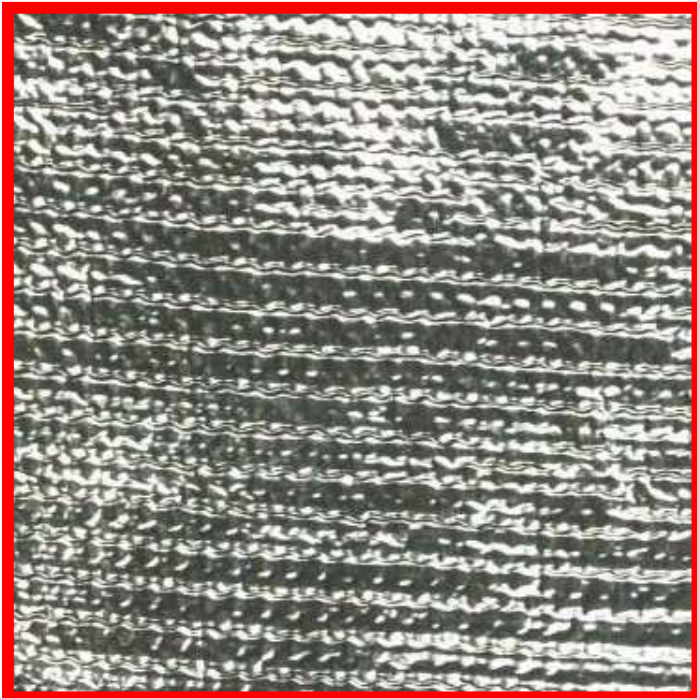

- Comprehensive line of radiant heat reflecting fabrics based on a poly-layered alu structure laminated to aramid, silica, OPAN-Aramid, PBI-Aramid and Carbon fleece base substrates. Excellent long-term flexibility.
- Protection from intense radiant heat up to 3000F.
- Reflects more than 95% of the radiant heat that contacts its surface.
- Excellent radiant heat protection from sources such as super-hot metal slabs, proximity to liquid metal, infrared heaters, open flame / plasma or engine exhaust manifolds is a concern.
- Suitable for workwear fabrication.

Poly-layered AluMax™ fabric offers protection when radiant heat from infrared sources such as super-hot metal slabs, proximity to liquid metal, open flame/plasma or engine exhaust manifolds is a concern. Constructed from a high-temperature base fabric which is then coated with heat reflective poly-layered aluminum. The base fabric has various thermal ratings while the radiant reflecting capability of the fabric is 3000°F.

<b>AluMax™ Aluminized Radiant Heat Reflective Protection Fabric</b>					
<b>Part Number (Base Material)</b>	<b>Base Fabric Temp</b>	<b>Weight oz/yd<sup>2</sup></b>	<b>Thickness in inches</b>	<b>Roll width in inches</b>	<b>Price per Linear Yard</b>
F-RHR-5260-13-K (Kove-Aramid) **	750°F / 398°C	13	.052	60	\$ Call
F-RHR-2560-11-PBIK (PB-Aramid)	800°F / 426°C	7.5	.022	60	\$ Call
F-RHR-6560-13-C (Pav-Carbon)	600°F / 315°C	13	.065	60	\$ Call
F-RHR-3960-11-C (Carbon Fleece)	750°F / 398°C	11	.039	60	\$ Call
F-RHR-2560-11-CK (OP-Aramid)	800°F / 426°C	11	.025	60	\$ Call
F-RHR-3038-19-S (Silica) *	1800°F / 982°C	19	.030	38	\$ Call

- **\*\* UL rated for PPE Gloves and other apparel. Meets AATCC-22 & AATCC-35**
- **This Product is Available By-The-Yard Except Where Indicated**
- **Discounts for full roll purchases**
- **\* Full 50 yard Rolls Only**



## Aluminum Flake Impregnated Fiberglass Heat Reflecting Fabric 1000°F / 537°C: AluFlake™ High Temperature & Radiant Heat Reflecting

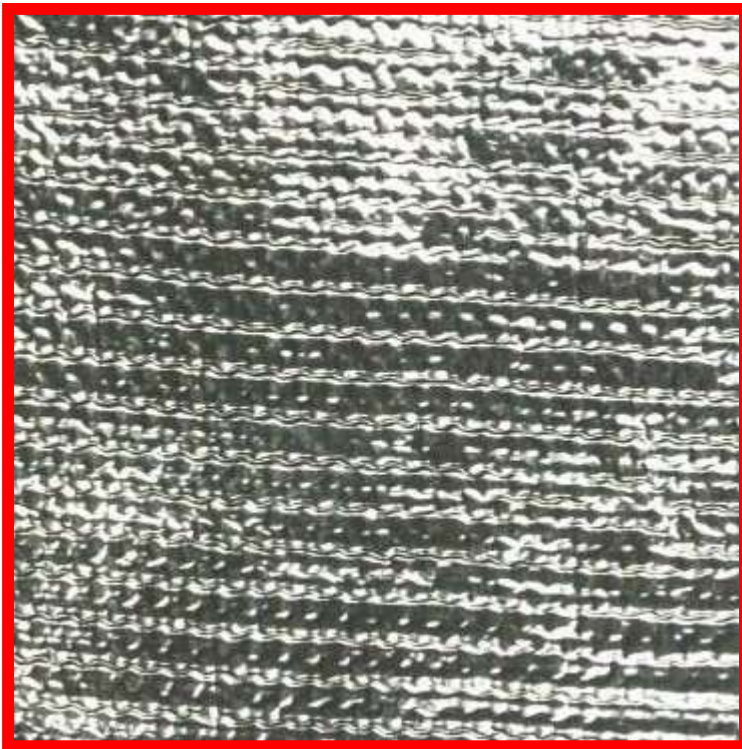

- Radiant heat reflecting fabrics based on an aluminum flake impregnation. Does not crack like aluminum foil coated fabrics and has a higher continuous exposure temperature than aluminum film coated fabrics.
- Protection from intense radiant heat up to 3000°F.
- Reflects more than 95% of the radiant heat that contacts its surface.
- Excellent radiant heat protection from sources such as super-hot metal slabs, proximity to liquid metal, infrared heaters, open flame / plasma or engine exhaust manifolds is a concern.

### AluFlake™ Aluminum Impregnated Fiberglass Fabric Radiant Heat Reflective Protection

Part Number	Weight oz/yd <sup>2</sup> / g/sq m	Thickness in / mm	Roll width in / mm	Price Linear Yard
F-FG-ALF-1458-12	12 / 340	.014 / 0.60	58 / 1524	\$ 184.68
F-FG-ALF-1258-9	9 / 645	.012 / 1.45	58 / 1016	\$ 103.29
F-FG-ALF-1238-9	9 / 746	.012 / 1.63	38 / 1016	\$ 69.27

- **Full rolls are 50 yards / 150 feet / 45.7 metres long**
- **This Product is also available By-The-Yard**
- **Discounts apply at 5, 10, 25 and 50 yard purchases**

## Stainless Steel Coated Fiberglass High Temperature & Radiant Heat Reflective Fabric

1000°F / 537°C: DeltaGlass™

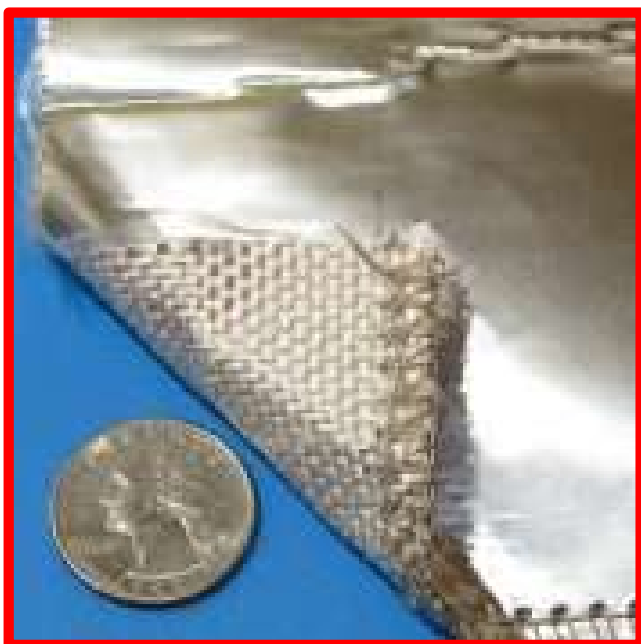

- Protection from intense radiant heat.
- Reflects more than 95% of the radiant heat that contacts its surface.
- A tougher corrosion resistant protection surface than aluminum coated products. Excellent molten splash, weld splatter and grinding spark protection.
- Flexible but much stiffer than aluminum coated fiberglass: sleeves and sleeves with Velcro crease and retain a bent shape when forced into a curve to follow a hose or cable path. Multiple shorter overlapping sections of sleeve reduces the amount of forced bending that may be required.
- Excellent radiant heat protection from sources such as super-hot metal slabs, proximity to liquid metal, infrared heaters, open flame / plasma or engine exhaust manifolds is a concern.

The Stainless Steel foil is calendared to the fiberglass substrate with an adhesive. The temperature limit of this laminate composite fabric is due to the limit of the adhesive material.

DeltaGlass™ Stainless Steel Foil Coated Fiberglass Fabric Radiant Heat Reflective Protection				
Part Number	Weight oz/yd <sup>2</sup>	Thickness in inches	Roll width in inches	Price per Yard
F-FG-SS-RHR-3036-34	34	.030	36	\$ 142.03

Call for pricing for sleeve, sleeve with Velcro and tape fabricated from this material.

Maximum continuous temperature exposure for this laminate is 500°F / 260°C, with short term higher exposures. Excellent corrosion resistance. Stainless Steel Foil Thickness: 0.002"

### Specifications

Weight:	34/oz/yd <sup>2</sup> - 1156 g/m <sup>2</sup> (+/- 10%)	ASTM-D-3776-96
Thickness:	0.030 +/- .001" - 0.762 mm +/- .025 mm	ASTM-D-1777-96
Tensile Strength:	Warp 250 lbs/in (44.72 kg/cm) Fill 200 lbs/in (35.72 kg/cm)	ASTM-D-5035-95
Tear Strength:	Warp 50 lbs (22.68 kg) Fill 50 lbs/in (22.68 kg)	ASTM-D-5587-96
Burst Strength	850 psi (59.5 kg/cm <sup>2</sup> )	ASTM-D-3786-87
Flame Resistance	Char length 1/16 in max (0.159cm max) Afterglow 1 sec max Flame Out 0 sec max	FED 191/5903.2

**Basalt Rock Fiber Cloth Fabric: Premium Grade**  
**1200°F / 648°C: Very High Temperature & Heat Resistant**

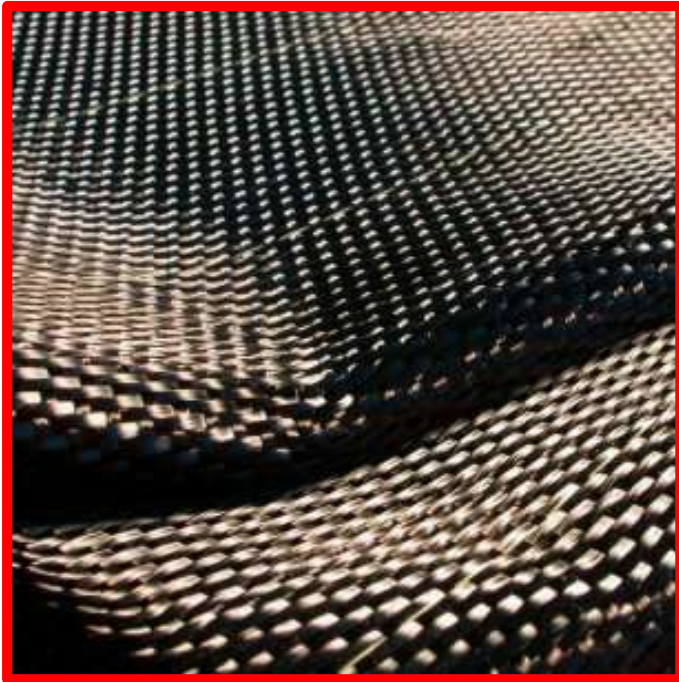

- Manufactured of basalt rock fiber: has a 1200°F / 648°C continuous rating while providing high insulation value & excellent personnel protection.
- Good abrasion resistance and tensile strength.
- Can replace aramid, fiberglass and carbon fibre fabrics.
- Used for many performance auto and motorsport applications due to its ability to handle high exhaust and turbo charger temperatures.
- Has a very shiny black gloss snakeskin appearance.

1200°F / 648°C continuous rating, high insulation value & excellent personnel protection

Very High Temperature & Heat Resistant Basalt Rock Fibre Cloth Roll Fabric				
Part Number	Weight oz/yd <sup>2</sup>	Roll Width In / cm	Thickness In / mm	Price per Yard / Metre
F-BRF-00850-6	6	50 / 127	.008 / .20	\$ 70.97 / \$ 77.39
F-BRF-2550-19	19	50 / 127	.025 / .64	\$ 104.90 / \$ 114.34
F-BRF-2550-20	20	50 / 127	.025 / .64	\$ 123.70 / \$ 134.83

Roll length is 150 Feet / 50 yards / 45 Metres. Please call for pricing on fabric with PSA

**These Products are Available By-The-Yard / Metre: Discounts for full roll purchases**

**Silica/Fiberglass Blend Fabrics: Premium Grade**  
**ProSil™ Plain fabric and ProSilMax™ Wire re-enforced fabric**  
**1350°F / 723°C: Very High Temperature & Heat Resistant**



- Fabric has a 1350°F / 723°C continuous rating while providing high insulation value & excellent personnel protection.
- Very good abrasion resistance and tensile strength.
- Remains soft, and pliable and conformable at temperatures where fiberglass materials become brittle.
- PROSILMAX has 1 strand of 621 Stainless Steel wire around each yarn of the fill.

1350°F / 723°C continuous rating, high insulation value & excellent personnel protection

Very High Temperature & Heat Resistant HTC Fiberglass Cloth Roll Fabric				
Part Number	Weight oz/yd <sup>2</sup>	Roll Width In / cm	Thickness In / mm	Price per Yard / Metre
F-PROSIL-3236-18	18	36 /	.032 / 0.81	\$ 30.16 / \$ 98.92
F-PROSIL-3260-18	18	60 / 152	.032 / 0.81	\$ 41.63 / \$ 136.54
F-PROSIL-4560-26	26	60 / 152	.045 / 1.14	\$ 56.50 / \$ 185.32
F-PROSILMAX-7060-35	35	60 / 152	.070 / 1.77	\$ 71.63 / \$ 234.94

Roll length is 150 Feet / 50 yards / 45 Metres. Please call for pricing on fabric with PSA

**These Products are Available By-The-Yard / Metre:**

**Discounts at 5, 10, 25 and 50 yard purchases**



## S-Glass Fiberglass: *Premium Grade*

1400°F / 760°C: Very High Temperature & Heat Resistant



- S-Glass Fiberglass has a 1400°F / 760°C continuous rating while providing high insulation value & excellent personnel protection.
- Very good abrasion resistance and tensile strength.
- S-Glass is a stronger and stiffer version of E-Glass and a higher modulus of elasticity (improved impact resistance over E-glass).
- S-Glass fabric is a very bright white color.

1400°F / 760°C continuous rating, high insulation value & excellent personnel protection

<b>Very High Temperature &amp; Heat Resistant S-Glass Fiberglass Cloth Roll Fabric</b>				
<b>Part Number</b>	<b>Weight oz/yd<sup>2</sup></b>	<b>Roll Width In / cm</b>	<b>Thickness In / mm</b>	<b>Price per Yard / Metre</b>
F-SFG-3260-19	19	60 / 152	.032 / .81	\$ 171.63 / \$ 187.08

Roll length is 150 Feet / 50 yards / 45 Metres. Please call for pricing on fabric with PSA

**These Products are Available By-The-Yard / Metre:**

**Discounts at 5, 10, 25 and 50 yard purchases**



**Vermiculite Coated Fiberglass Cloth Fabric (Fireblanket)**  
**1500°F / 815°C: FlameShield™ 1500 VC Very High Temperature & Heat Resistant**



Manufactured of E-glass yarns, woven, and then immersed in a vermiculite dispersion to add thermal performance and additional abrasion resistance, this fabric has a 1500°F / 815°C continuous rating while providing high insulation value & excellent personnel protection. The polymer additive in the vermiculite dispersion provides a binding agent to make the fabric stiffer, easier to cut and handle, and provides anti-fray properties.

This material has been independently tested and is certified to meet the requirements of ASTM E 162, ASTM E 662 & SMP 800-C for low surface flammability, smoke and toxic gas generation. Also meets Federal Railroad Administration requirements for surface flammability and rate of smoke generation. Good abrasion resistance and tensile strength. Available with a PSA (pressure sensitive adhesive\*) applied to one side for ease of application while fastened into position.

A high-performance extreme-temperature fabric, used in almost all industries for the high heat protection and abrasion resistance.

**Vermiculite Coated Fiberglass Cloth Fabric (Continued)**  
**1500°F / 815°C: FlameShield™ 1500 VC Very High Temperature & Heat Resistant**



<b>DeltaGlass™ VC Very High Temperature &amp; Heat Resistant Vermiculite Coated Fiberglass Cloth / Fabric / Fireblanket</b>				
<b>Part Number</b>	<b>Weight oz/yd<sup>2</sup></b>	<b>Roll Width In / cm</b>	<b>Thickness In / mm</b>	<b>Price per linear yard</b>
F-FG-VC-2060-10	10	60 / 152	.020 / 0.51	\$ 23.71
F-FG-VC-6040-24	24	40 / 101	.060 / 1.52	\$ 38.88
F-FG-VC-6060-24	24	60 / 152	.060 / 1.52	\$ 54.00
F-FG-VC-6540-30	30	40 / 101	.065 / 1.65	\$ 43.74
F-FG-VC-6560-30	30	60 / 152	.065 / 1.65	\$ 63.56
F-FG-VC-7540-36	36	40 / 101	.075 / 1.91	\$ 47.31
F-FG-VC-7560-36	36	60 / 152	.075 / 1.91	\$ 84.83
F-FG-VC-9040-40	40	40 / 101	.090 / 2.29	\$ 50.94
F-FG-VC-9060-40	40	60 / 152	.090 / 2.29	\$ 90.63
F-FG-VC-12540-64	64	40 / 101	.125 / 3.18	\$ 98.72
F-FG-VC-12560-64	64	60 / 152	.125 / 3.18	\$ 164.64
** F-FG-VC-3560-20	20	60 / 152	.035 / 0.89	\$40.50
With Wire Insert				
F-FG-VC-WI-5360-26	26	60 / 152	.053 / 1.52	\$ 152.64
F-FG-VC-WI-7060-36	36	60 / 152	.070 / 1.78	\$ 147.18
F-FG-VC-WI-7060-41	41	60 / 152	.070 / 1.78	\$ 220.26

Roll length is 50 yards / 45 Metres. Please call for pricing on fabric with PSA

\*\*VCFCB cloth has a very high vermiculite content (10 to 12%). Allows for short term exposure to 2000°F and exceptional abrasion resistance.

\* Note: If the fabric has PSA added, the PSA will burn off at temperatures above 400°F and should be used to facilitate installation. Material with PSA should not be used in confined areas at elevated temperatures without ventilation until all of the PSA has vaporized.

**This Product is Available By-The-Yard: Discounts for full roll purchases**



**Silica Cloth with one side silicone rubber coating: Medium duty**  
**1800°F / 982°C: InSilMax™ with 500°F / 260°C: FlameShield™ Silicone Rubber**  
**Coating - High Temperature, Heat & Flame Resistant**  
**Molten Metal SplashGuard™ / Fire Blanket / Welding Blanket / Curtains-Shields**

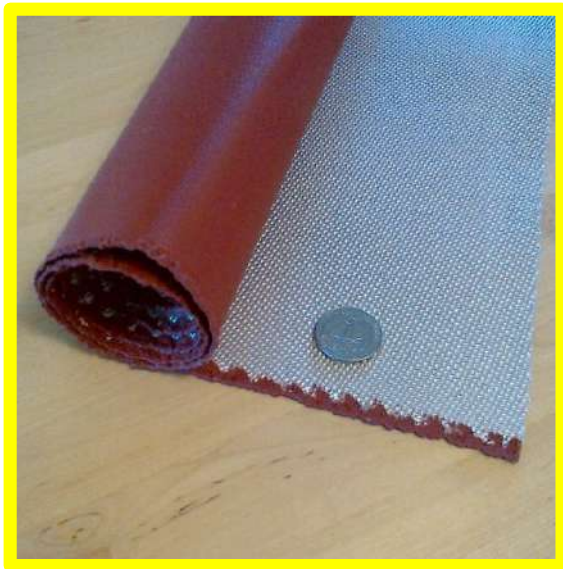

- *Coated on one side: total weight 50 oz/yd<sup>2</sup>*
- *Makes excellent molten metal splash, welding splatter, plasma spray & grinding spark shields and curtains*
- *Robotic welding arm and elbow covers & cable protectors*
- *Plasma cutting head splatter protection*
- *Silicone rubber coating provides anti-fray and mounting/fastening options. Use with silicone coating side mounted towards splatter/splash source but mounted away from higher dry heat source for longer product life.*

<b>InSilMax™ one side silicone rubber coated high temperature Silica fabric</b>					
<b>Part Number</b>	<b>Weight Linear foot / oz/yd<sup>2</sup></b>	<b>Roll Width In / cm</b>	<b>Thickness In / mm</b>	<b>Price per Yard</b>	<b>Price per Metre</b>
F-S-SR1-6336-50*	1.10 lbs / 50	36 / 91	0.063 / 1.60	\$ 144.41	\$ 157.84

The color of this fabric is oxide-red  
 available in 50 yard rolls

Heavy Duty 50 oz/yd<sup>2</sup> and other lighter fabrics and 2 side coated fabrics are used as high temperature curtains and shields, weld splatter and pyro resistant sleeves and jackets, weather or spray-down / wash-down resistant high temperature fabric for making protective covers, sleeves, jackets. Very good molten metal splash protection.

Coated fabrics provide excellent cold temperature performance with flexibility to -76°C for refrigeration and cryogenic applications. These materials can be easily used to make shield and covers that are assembled with mechanical fasteners. Easily punched or drilled for installation of grommets, or insertion of sheet metal screws or bolts.

**This Product is Available By-The-Yard / Metre: Discounts for full roll purchases  
 Custom Slitting to Any Width Available**

## Silica Cloth Fabric FireBlanket-weld protection blanket 1800°F / 982°C: InSilMax™ Extreme High Temperature, Heat, Flame, Molten Metal & Weld Splatter / Slag / Spark Resistant



- An alternative to asbestos and ceramic based textiles.
- Highly flexible and minimal shrinkage.
- High abrasion resistance and tensile strength.
- Melts above 3000°F / 1648°C.
- Produced from an extremely pure base fiber and can be used at 1800°F / 982°C continuously with excursions to 3000°F / 1650°C.
- InSilMax provides burn-through protection from molten metal and weld splatter/slag/sparks.
- A high-performance extreme-temperature fabric, used in almost all industries for the highest heat protection available.

1800°F / 982°C continuous rating, high insulation value & excellent personnel protection

InSilMax™ Extreme Temperature Silica Cloth Fabric				
Part Number	Weight oz/yd <sup>2</sup>	Roll Width In / cm	Thickness In / mm	Price per yard / metre
F-S-2836-18	18	36 / 91	.028 / .71	\$ 35.13 / \$ 38.29
F-S-3036-18 (satin weave)	18	36 / 91	.030 / .76	\$ 39.00 / \$ 42.51
F-S-3060-18 (satin weave)	18	60 / 152	.030 / .76	\$ 72.12 / \$ 78.61
F-S-5436-36 (satin weave)	36	36 / 91	.054 / 1.4	\$ 68.48 / \$ 74.64
F-S-5460-36 (satin weave)	36	60 / 152	.054 / 1.4	\$ 123.20 / \$ 134.29
F-S-6540-32	32	40 / 101	.065 / 1.6	\$ 128.60 / \$ 140.17
F-S-8540-38	38	40 / 101	.085 / 2.2	\$ 151.13 / \$ 164.74
F-S-9038-40	40	38 / 96	.090 / 2.3	\$ 96.08 / \$ 104.73
F-S-11540-50	50	40 / 101	.115 / 2.9	\$ 139.70 / \$152.27

InSilMax™ Extreme Temperature Silica Cloth Fabric with Vermiculite Coating – Sold Full Roll Only				
Part Number	Weight oz/yd <sup>2</sup>	Roll Width In / cm	Thickness In / mm	Price per yard / metre
F-S-VC-2840-18 *	18	40 / 101	.028 / 0.71	\$ 38.63 / \$ 42.11
F-S-VC-6540-33	33	40 / 101	.065 / 1.65	\$ 146.37 / \$ 159.54
F-S-VC-9540-42	42	40 / 101	.095 / 2.4	\$ 168.97 / \$ 184.17
F-S-VC-12540-55	55	40 / 101	.125 / 3.2	\$ 184.78 / \$ 201.40

Vermiculite coating adds abrasion resistance and adds significantly to the fabric's durability.  
\* Coating on this item is light duty.

These products are available in 150 foot / 50 yard / 45.8 metre rolls

Items highlighted in yellow are FM Approval Class 4950 – Meets MIL-I-24244 & MIL-C-24576(SH) specifications

**These Products are Available By-The-Yard / Metre Except as Indicated  
Discounts for full roll purchases**





## Silica Cloth Fabric – Fireblanket

### 1900°F / 1037°C: InSilMax™ XT Extreme High Temperature, Heat, Flame, Molten Metal & Weld Splatter Resistant



- An alternative to asbestos and ceramic based textiles.
- Highly flexible and minimal shrinkage.
- High abrasion resistance and tensile strength.
- Melts above 3000°F / 1648°C.
- Produced from an extremely pure base fiber and can be used at 1900°F / 1037°C continuously with excursions to 3000°F / 1650°C.
- InSilMax provides burn-through protection from molten metal and weld splatter.
- A high-performance extreme-temperature fabric, used in almost all industries for the highest heat protection available

1900°F / 1037°C continuous rating, high insulation value & excellent personnel protection

<b>InSilMax™ XT Extreme Temperature Silica Cloth Fabric</b>				
<b>Part Number</b>	<b>Weight oz/yd<sup>2</sup></b>	<b>Roll Width In / cm</b>	<b>Thickness In / mm</b>	<b>Price per yard / metre</b>
F-S-XT-2836-18	18	36 / 91	.028 / .71	\$ 40.40 / \$ 44.03
F-S-XT-3036-18	18	36 / 91	.030 / .76	\$ 44.85 / \$ 48.89
F-S-XT-3060-18	18	60 / 152	.030 / .76	\$ 82.94 / \$ 90.40
F-S-XT-5436-24	24	36 / 91	.054 / 1.4	\$ 78.75 / \$ 85.84
F-S-XT-5460-24	24	60 / 152	.054 / 1.4	\$ 141.68 / \$ 154.43
F-S-XT-6540-32	32	40 / 101	.065 / 1.6	\$ 147.89 / \$ 161.19
F-S-XT-8540-38	38	40 / 101	.085 / 2.2	\$ 173.80 / \$ 189.45
F-S-XT-9038-40	40	38 / 96	.090 / 2.3	\$ 110.49 / \$ 120.44
F-S-XT-9060-40	40	60 / 152	.090 / 2.3	\$ 156.68 / \$ 170.78
F-S-XT-11540-50	50	40 / 101	.115 / 2.9	\$ 160.67 / \$ 175.11

<b>InSilMax™ XT Extreme Temperature Silica Cloth Fabric with Vermiculite Coating – Sold Full Roll Only</b>				
<b>Part Number</b>	<b>Weight oz/yd<sup>2</sup></b>	<b>Roll Width In / cm</b>	<b>Thickness In / mm</b>	<b>Price per yard / metre</b>
F-S-XT-VC-2840-18 *	18	40 / 101	.028 / 0.71	\$ 44.43 / \$ 48.42
F-S-XT-VC-6540-33	33	40 / 101	.065 / 1.65	\$ 168.32 / \$ 183.47
F-S-XT-VC-9540-42	42	40 / 101	.095 / 2.4	\$ 194.32 / \$ 211.80
F-S-XT-VC-12540-55	55	40 / 101	.125 / 3.2	\$ 267.30 / \$ 291.35

Vermiculite coating adds abrasion resistance and adds significantly to the fabric's durability.  
 \* Coating on this item is light duty.

These products are available in 150 foot / 50 yard / 45.8 metre rolls

**These Products are Available By-The-Yard / Metre Except as Indicated**  
**Discounts for full roll purchases**



## Alumina Cloth Fabric

2300°F / 1260°C: AluMax™ Extreme High Temperature, Heat, Flame, Molten Metal & Weld Splatter Resistant



- An alternative to asbestos and ceramic based textiles.
- Highly flexible and minimal shrinkage.
- High abrasion resistance and tensile strength.
- Melts above 3000°F / 1648°C.
- Produced from an extremely pure base fiber and can be used at 2300°F / 1260°C continuously with excursions to 3000°F / 1650°C.
- AluMax provides burn-through protection from molten metal and weld splatter.
- A high-performance extreme-temperature fabric, used in almost all industries for the highest heat protection available

2300°F / 1260°C continuous rating, high insulation value & excellent personnel protection

AluMax™ Extreme Temperature Fabric Alumina Cloth Blanket				
Part Number	Weight oz/yd <sup>2</sup>	Roll Width In / cm	Thickness In / mm	Price per yard / metre
F-ALUMINA-1940-14	14	40 / 101	.019 / .48	\$ 521.44 / \$ 568.37
F-ALUMINA-3840-20	20	40 / 101	.038 / .96	\$ 488.74 / \$ 532.73

These products are available in 150 foot / 50 yard / 45.8 metre rolls

**Full roll purchase only**

**Ceramic Fiber Paper**  
**2000°F / 1093°C: CerMax™ Extreme High Temperature, Heat & Flame Resistant:**  
**Premium Grade**



- An alternative to asbestos.
- Light-weight, flexible, good handling strength
- Low thermal conductivity, good dielectric strength
- Excellent corrosion resistance
- Can be die-cut or stamped
- Produced from an extremely pure alumino-silicate ceramic fiber non woven fabric.
- Can be used at 2000°F / 1093°C continuously, with peaks to 2300°F / 1260°C. Melts above 3000°F.

2000°F / 1093°C continuous rating, high insulation value & excellent personnel protection

CerMax™ Extreme High Temperature, Heat & Flame Resistant Ceramic Fiber Compressed Mat Paper: Premium Grade					
Part Number	Thickness in / mm		Feet per Roll	Roll Width in / cm	Price per yard
F-C-CMP-03124	.031	0.8	200	24 / 60.9	\$ 18.72
F-C-CMP-06224	.062	1.6	100	24 / 60.9	\$ 21.17
F-C-CMP-06248	.062	1.6	125	48 / 121.9	\$ 31.68
F-C-CMP-12548	.125	3.2	62.5	48 / 121.9	\$ 49.44
F-C-CMP-25048	.250	6.4	33	48 / 121.9	\$ 57.48

**Technical Specifications**

Density: 10 lb/cu ft  
 Chemical Composition: Al<sub>2</sub>O<sub>3</sub> 47%; Total Al<sub>2</sub>O<sub>3</sub> and SiO<sub>2</sub> > 97%' Fe<sub>2</sub>O<sub>3</sub> <1.0%  
 Tensile Strength: 25 lbs  
 Thermal Conductivity: 500°F: 0.38 (0.05); 1000°F: 0.61 (0.09); 1500°F: 0.94 (0.14);  
 2000°F: 1.40 (0.20)

Resistant to most chemicals except hydrofluoric, phosphoric acids and concentrated alkalis.

This product may have some minor edge compression extending to a few inches due to shipping shift and handling. This is normal and unavoidable due to the low relative tensile strength of this product.

**The 48 inch wide products are available By-The-Yard. Discounts for full roll purchases**

**Ceramic Fibre Cloth Fabric**  
**2300°F / 1260°C: CerMax™ Extreme Temperature Premium Grade**



- An alternative to asbestos based textiles.
- Highly flexible and minimal shrinkage.
- High abrasion resistance and tensile strength.
- Melts above 3000°F / 1648°C.
- Highest purity ceramic fibre.

**Ceramic Fibre Cloth Fabric (Continued)**  
2300°F / 1260°C: CerMax™ Extreme Temperature Premium Grade



This is a high-performance extreme-temperature fabric, used in almost all industries for the highest heat protection available.

Some organic binder material from manufacturing may remain in the product - it should be brought to service temperature over time in order to burn off those organics. Fast heating may caramelize the organics.

2300°F / 1260°C continuous rating, high insulation value & excellent personnel protection

<b>CerMax™ Extreme High Temperature +Plus, Heat &amp; Flame Resistant Premium Ceramic Fibre Blanket Cloth Fabric</b>				
<b>Part Number</b>	<b>Weight oz/yd<sup>2</sup></b>	<b>Roll Width In / cm</b>	<b>Thickness In / mm</b>	<b>Price per roll</b>
<b>1/16" / .0625" / 1.6mm Thick</b>				
F-C-P-06236-22-1-IWI*	22	36 / 91	.0625 / 1.6	\$ 1593.21
F-C-P-06236-21-1-FGI**	21	36 / 91	.0625 / 1.6	\$ 1442.67
<b>1/8" / .125" / 3.2mm Thick</b>				
F-C-P-12536-43-2-IWI*	43	36 / 91	.125 / 3.2	\$ 2233.00
F-C-P-12536-41-2-FGI**	41	36 / 91	.125 / 3.2	\$ 2046.25

\* This material contains an inconel wire insert  
\*\* This material contains a glass filament insert

This product is available in 16.6 yard / 50 foot rolls

**This Product is NOT Available By-The-Yard: Discounts for full roll purchases**

**Ceramic Fibre Cloth Fabric: *Industrial Grade***  
**2300°F / 1260°C: CerMax™ Extreme Temperature +Plus**



- An alternative to asbestos based textiles.
- Highly flexible and minimal shrinkage.
- High abrasion resistance and tensile strength.
- Melts above 3000°F / 1648°C.

This is a high-performance extreme-temperature fabric, used in almost all industries for the highest heat protection available.

2000°F / 1260°C continuous rating, high insulation value & excellent personnel protection

<b>CerMax™ Extreme High Temperature +Plus, Heat &amp; Flame Resistant Premium Ceramic Fibre Blanket Cloth Fabric</b>					
<b>Part Number</b>	<b>Weight oz/yd<sup>2</sup></b>	<b>Roll Width In / cm</b>	<b>Thickness In / mm</b>	<b>Price per roll</b>	<b>Price per yard</b>
<b>1/16" / .0625" / 1.6mm Thick</b>					
F-C-I-06236-22-1-IWI*	22	36 / 91	.0625 / 1.6	\$ 806.25	\$ 67.16
F-C-I-06236-21-1-FGI**	21	36 / 91	.0625 / 1.6	\$ 925.66	\$ 77.08
<b>1/8" / .125" / 3.2mm Thick</b>					
F-C-I-12536-43-2-IWI*	43	36 / 91	.125 / 3.2	\$ 1067.50	\$ 88.91
F-C-I-12536-41-2-FGI**	41	36 / 91	.125 / 3.2	\$ 1083.30	\$ 90.25

This product is available in 33 yard / 99 foot rolls

- \* This material contains an inconel wire insert
- \*\* This material contains a glass filament insert

**This Product is Available By-The-Yard**



**CerMax Fabric Technical Data**

CerMax is alumino-silicate based refractory fiber. White and odorless. Available with either a fiberglass or wire re-inforcement. Some organic binder is present, and will smoke-off at elevated temperatures. Once the organics have smoked-off, the product will turn white again. If smoke free operation is required, then it should be heat treated before use.

**Chemical & Physical Data:** Total  $Al_2O_3$  and  $SiO_2$  > 97% ( $Al_2O_3$ : 47%);  $Fe_2O_3$  <1.1%. Weight Loss (1800°F) 8-10%; Refractory Fiber content >85%. Fiber diameter: 2 - 4 microns; Fiber length: 100 - 250 mm. Fiber shrinkage (1800°F, 3 hr) <3.5%

**Thermal Conductivity:** 570°F: 0.84 BTU/ft<sup>2</sup> °F/in (0.12 W/m °K). 1100°F: 0.91 BTU/ft<sup>2</sup> °F/in (0.13 W/m °K). 1800°F: 1.19 BTU/ft<sup>2</sup> °F/in (0.17 W/m °K).

## Knitted Stainless Mesh Fabric 1200°F / 648°C & 2300°F / 1260°C 304 Stainless Steel & Inconel

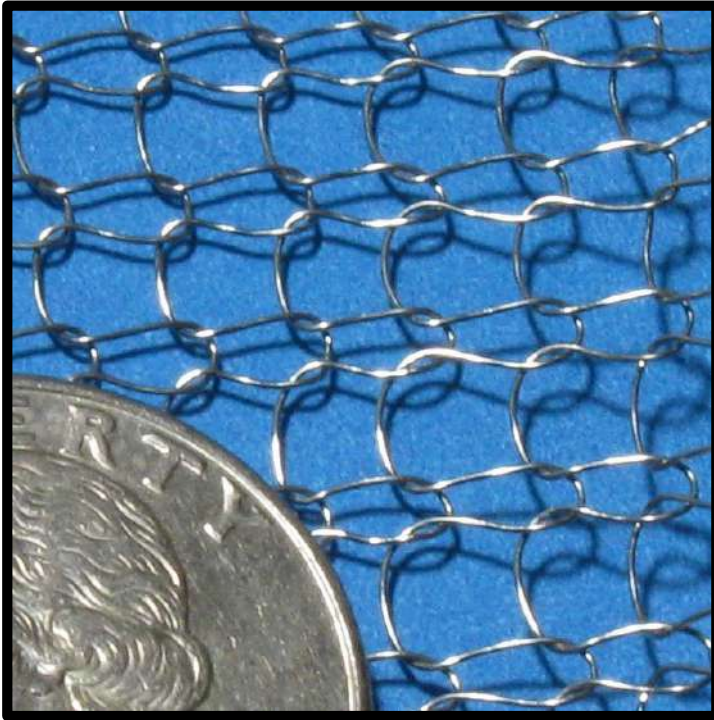

- 304 Stainless Steel Knitted Mesh. Fabricated from using .011" diameter wire.
- Inconel Knitted Mesh is fabricated from .008" diameter wire.
- Used to support needed insulation blanket and felt in fabricated exhaust system removable blankets or to overwrap into place other high temperature blankets to hold in place onto a vessel or pipe.
- Many other uses where a guard or other protective aperture is required in hot applications.
- Knit Mesh allows two way stretch; unlike woven mesh.

Stainless Steel Knit Mesh is useable to 1200°F / 648°C.  
Inconel Knit Mesh is useable to 2300°F/1260°C.

Knitted Mesh Fabric: 304 Stainless Steel & Inconel				
Part Number	Material	Weight oz/yd <sup>2</sup>	Roll width in inches	Price per Yard
F-SSMF-30	Stainless Steel	11	30"	\$ 27.67
F-SSMF-42	Stainless Steel	11	42"	\$ 32.48
F-ISMF-30	Inconel	10	30"	\$ 193.57

Rolls are produced as 50 pound roll: Approximately 13 sq ft/pound.  
Roll Length is approx 43 yards for 30" wide roll and 30 yards for 42" wide roll.

This knitted mesh is produced as a tubular sleeve: and when rolled flat it is therefore a "double layer" of mesh, which users typically cut open to use as a single layer in their applications. The 30" width when cut open is 60" wide and the 42" roll when cut open is 84" wide.

Other knit mesh materials are available by special order: Plain Steel, Galvanized Steel, Aluminum, Copper, Tinned Copper, Inconel, Monel, Tungsten, Tantalum, Platinum, Gold Alloy, Gold Plated Copper, Silver Plated Copper, Polypropylene, Polyethylene, Nylon.

**Molten Metal Filter Media**  
3000°F / 1620°C Pour temperature

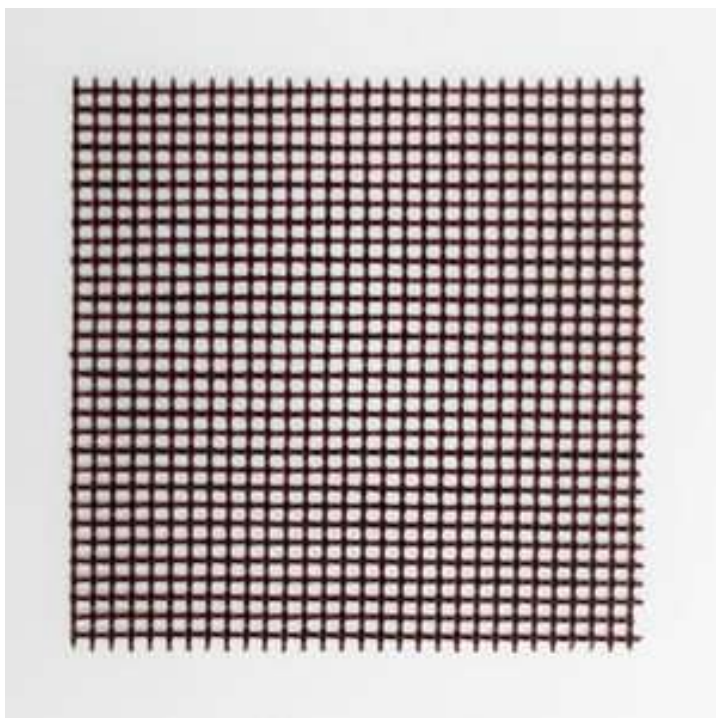

- High purity silica yarns with phenolic resin coating in a Leno weave.
- Available in sheet form or as precut squares.
- 3 grid sizes available: 1.5mm x 1.5mm (132 openings per square inch); 2.0mm x 2.0mm (91 openings per square inch); 2.0mm x 3.0mm (75 openings per square inch).
- Available in 5.75" x 11.75" standard sheets, 31" x 39" large sheets, or in precut squares of 2"x2", 2.5"x2.5", 3"x3" and 4"x4".

<b>High Temperature Liquid Metal Filter Mesh</b>			
<b>Part Number</b>	<b>Mesh Dimension</b>	<b>Sheet Size</b>	<b>Price Each</b>
F-S-MESH-1.5-S	1.5mm x 1.5mm	5.75" x 11.75"	\$ 8.64
F-S-MESH-2.0-S	2.0mm x 2.0mm	5.75" x 11.75"	\$ 8.64
F-S-MESH-2x3-S	2.0mm x 3.0mm	5.75" x 11.75"	\$ 8.64
F-S-MESH-1.5-L	1.5mm x 1.5mm	31" x 39"	\$ 127.59
F-S-MESH-2.0-L	2.0mm x 2.0mm	31" x 39"	\$ 127.59
F-S-MESH-2x3-L	2.0mm x 3.0mm	31" x 39"	\$ 127.59
For 2"x2", 2.5"x2.5", 3"x3" and 4"x4" cut squares please call			

# Sheet Materials

GraphTek™ Flexible Graphite Sheet and Roll .....	4-50
FlameShield™ Silicone Rubber Square Sheeting .....	4-51
FlameShield™ Silicone Rubber Sheet Roll - Premium Grade.....	4-52
FlameShield™ Silicone Rubber Sheet Roll - Highest Temperature Grade .....	4-53
FlameShield™ Silicone Rubber Sheet Roll - Commercial Grade Red/Grey/Black .....	4-54
FlameShield™ Silicone Rubber Sheet Roll - FDA Food Grade White .....	4-56
FlameShield™ Silicone Rubber Sheet Roll - Medical Grade .....	4-57
FlameShield™ Silicone Rubber Sheet Roll - Translucent .....	4-58
FlameShield™ Silicone Rubber Sheet Roll - Fluorosilicone .....	4-59
FlameShield™ Silicone Rubber Sheet Roll - Electrically Conductive .....	4-60
FlameShield™ Silicone Rubber Sheet Roll - High Strength .....	4-61
FlameShield™ Silicone Rubber Sheet Roll - Extreme Low Temperature Flexibility .....	4-62
FlameShield™ Silicone Rubber Sheet Roll - Silicone Vacuum Blanket .....	4-63



## Flexible Graphite Sheets and Rolls 950°F / 510°C to 5400°F / 2982°C: GraphTek™



- Plain or reinforced sheets, laminates and rolls.
- Available with 316 Stainless Steel Foil Insert, Tang Insert, 316 Stainless Steel Wire Insert, Mylar Insert
- Flexible Graphite is 99% Carbon, providing extreme heat protection, thermal dissipation, lubrication but not electrical conductivity. Made from mineral (flake) graphite it is non metallic, but thermally and electrically conductive just like metals.
- Sheets are 39.4 inches x 39.4 inches and are cut from roll material.
- Premium grade has low sulphur content.

Service temperature range depends on surrounding conditions. Useable to 950°F / 510°C in an oxidizing atmosphere (standard air). Useable to 1500°F / 815°C in mild oxidizing or steam atmosphere and useable to 5400°F / 2982°C in non-oxidizing conditions.

GraphTek™ Flexible Homogeneous Graphite Sheet Roll					
Part Number	Thickness in inches/mm	"A" 39.4" x 100' roll	"B" 39.4" x 39.4" Sheet	"C" 60" x 200' roll	"D" 5" x 108' roll
F-GR-005-X	.005 / .127	\$ 182.50	\$ 56.25	NA	NA
F-GR-010-X	.010 / .254	\$ 221.25	\$ 63.75	NA	NA
F-GR-015-X	.015 / .381	\$ 260.00	\$ 73.75	\$ 635.00	NA
F-GR-020-X	.020 / .508	\$ 338.75	\$ 85.00	\$ 1005.00	\$ 48.75
F-GR-025-X	.025 / .635	\$ 647.97			
F-GR-030-X	.030 / .762	\$ 492.50	\$ 107.50	NA	\$ 68.75
F-GR-040-X	.040 / 1.016	\$ 595.00	\$ 131.25	NA	NA

GraphTek Flexible Homogeneous Graphite Sheet Roll Premium Grade					
F-GR-P-015-X	.015 / .381		\$ 607.50	NA	NA
F-GR-P-0625-X	.0625 / 1.587		\$ 1316.25	NA	NA

GraphTek Flexible Graphite Laminate Sheet: 39.4" x 39.4"					
F-GR-316SS Foil		NA	\$ Call	NA	NA
F-GR-316SS-Tang		NA	\$ Call	NA	NA
F-GR-316SS-Wire		NA	\$ Call	NA	NA
F-GR-Mylar		NA	\$ Call	NA	NA
F-GR-Carbon Steel		NA	\$ Call	NA	NA

For the "X" value, Specify A, B, C or D in part number to correspond to the desired size

Due to the nature of graphite sheet materials, additional protective packaging is required for shipping. A \$15.00 special packaging fee is charged for all GraphTek products. Sheet products also incur an extra oversize fee from UPS when shipped (typically \$8.00).



**Silicone Rubber Square Sheetting – Ultra Grade**  
**500°F / 260°C: FlameShield™ - High Temperature, Heat & Flame Resistant**  
**Hot process protection**



- Used as a heat resistant pad for hot process work.
- High thermal conductivity.
- High electrical resistance.
- Resistant to weld splatter, grinding sparks, solder drips, brazing.
- Can be used to fabricate large gaskets.
- Durometer of 50 +/- 5%. Elongation 350%. Tensile 725 psi. Color is Oxide-Red.
- Meets MIL-STD A-A-59588 Class 2A & 2B (ZZ-R-765)

<b>FlameShield™ high temperature silicone rubber square sheet</b>			
<b>Part Number</b>	<b>Size</b>	<b>Thickness fraction / in / mm</b>	<b>Price</b>
F-SR50-36-36-031	36" x 36"	1/32" / .031 / 0.79	\$ 113.76
F-SR50-36-36-062	36" x 36"	1/16" / .062 / 1.57	\$ 126.13
F-SR50-36-36-093	36" x 36"	3/32" / .093 / 2.36	\$ 203.15
F-SR50-36-36-125	36" x 36"	1/8" / .125 / 3.18	\$ 280.53
F-SR50-36-36-187	36" x 36"	3/16" / .187 / 4.75	\$ 335.22
F-SR50-36-36-250	36" x 36"	¼" / .250 / 6.35	\$ 457.12
F-SR50-36-36-375	36" x 36"	3/8" / .375 / 9.52	\$ 552.68
F-SR50-36-36-500	36" x 36"	½" / .500 / 12.70	\$ 751.87

The color is oxide-red

This item is cut to size from our bulk rolls

These sheets can be easily used to make shields and covers that are assembled with mechanical fasteners. Easily punched or drilled for installation of grommets, or insertion of sheet metal screws or bolts.

## Silicone Rubber Sheet Rolls – Premium Grade

### 500°F / 260°C: FlameShield™ - High Temperature, Heat & Flame Resistant

#### Hot process protection



- Used as a heat resistant pad for hot process work.
- High thermal conductivity.
- High electrical resistance.
- Resistant to weld splatter, grinding sparks, solder drips, brazing.
- Can be used to fabricate large gaskets.
- Durometer of 50 +/- 5%, 60 +/-5% or 70 +/- 5%. Elongation 350%. Tensile 725 psi. Color is Oxide-Red.
- Meets MIL-STD A-A-59588 Class 2A & 2B (ZZ-R-765)

FlameShield™ high temperature silicone rubber sheet Premium Grade				
Part Number	Durometer	Roll Size / Wt lbs	Thickness in / mm	Price / linear ft
F-SR50-PG-36-062-X	50	36" x 50' / 61	1/16" / .062 / 1.57	\$ 22.23
F-SR50-PG-36-093-X	50	36" x 50' / 92	3/32 / .093 / 2.36	\$ 33.20
F-SR50-PG-36-125-X	50	36" x 50' / 122	1/8" / .125 / 3.18	\$ 44.86
F-SR50-PG-36-250-X	50	36" x 50' / 244	1/4" / .250 / 6.35	\$ 89.70
F-SR50-PG-48-250-X	50	48" x 50' / 326	1/4" / .250 / 6.35	\$ 120.90
F-SR60-PG-36-062-X	60	36" x 50' / 61	1/16" / .062 / 1.57	\$ 22.23
F-SR60-PG-36-125-X	60	36" x 50' / 122	1/8" / .125 / 3.18	\$ 44.86
F-SR60-PG-36-250-X	60	36" x 50' / 244	1/4" / .250 / 6.35	\$ 89.70
F-SR60-PG-48-062-X	60	48" x 50' / 82	1/16" / .062 / 1.57	\$ 29.56
F-SR60-PG-48-125-X	60	48" x 50' / 163	1/8" / .125 / 3.18	\$ 59.66
F-SR60-PG-48-250-X	60	48" x 50' / 326	1/4" / .250 / 6.35	\$ 120.90
F-SR70-PG-36-062-X	70	36" x 50' / 61	1/16" / .062 / 1.57	\$ 22.23
F-SR70-PG-36-093-X	70	36" x 50' / 92	3/32 / .093 / 2.36	\$ 33.20
F-SR70-PG-36-125-X	70	36" x 50' / 122	1/8" / .125 / 3.18	\$ 44.86
F-SR70-PG-36-250-X	70	36" x 50' / 244	1/4" / .250 / 6.35	\$ 89.70
F-SR70-PG-48-062-X	70	48" x 50' / 82	1/16" / .062 / 1.57	\$ 29.56
F-SR70-PG-48-093-X	70	48" x 50' / 122	3/32 / .093 / 2.36	\$ 44.13
F-SR70-PG-48-125-X	70	48" x 50' / 163	1/8" / .125 / 3.18	\$ 59.66
F-SR70-PG-48-250-X	70	48" x 50' / 326	1/4" / .250 / 6.35	\$ 120.90

- For the "X" value, Specify "F" for by-the-foot length, or "R" for full 50 foot.

Available by the linear foot. Full roll (50 feet) purchase is -10% pricing  
This item is normally stock

These materials can be easily used to make shields and covers that are assembled with mechanical fasteners. Easily punched or drilled for installation of grommets, or insertion of sheet metal screws or bolts.

## Silicone Rubber Sheet Rolls – High Temperature Grade

### 600°F / 315°C: FlameShield™ - High Temperature, Heat & Flame Resistant

#### Hot process protection



- Used as a heat resistant pad for hot process work.
- High thermal conductivity.
- High electrical resistance.
- Resistant to weld splatter, grinding sparks, solder drips, brazing.
- Can be used to fabricate large gaskets.
- Durometer of 60 +/-5% ASTM D2240
- Elongation 350%. ASTM D412
- Tensile 1000 psi. ASTM D412
- Specific Gravity 1.45 g/cc. ASTM D297
- Tear 70 PPI Die "B". ASTM D624
- Color is Oxide-Red.
- Meets MIL-STD A-A-59588 Class 2A & 2B (ZZ-R-765)
- UV / Ozone Resistant. Non Toxic, Chemically Inert, Low Compression Set, FDA approved ingredients

#### Aged performance:

168 hours at 600F: Shore A +29%, Tensile -56%, Elongation -89%

FlameShield™ high temperature silicone rubber sheet				
Part Number	Durometer	Roll Size / Wt lbs	Thickness in / mm	Price / linear yard
F-SR60HT-36-032-X	60	36" x 50' / 30	1/32" / .031 / 0.78	\$ 98.35
F-SR60HT-36-062-X	60	36" x 50' / 61	1/16" / .062 / 1.57	\$ 107.33
F-SR60HT-36-125-X	60	36" x 50' / 122	1/8" / .125 / 3.18	\$ 176.65
F-SR60HT-36-250-X	60	36" x 50' / 244	1/4" / .250 / 6.35	\$ 297.37

- For the "X" value, Specify "Y" for by-the-yard length, or "R" for full 50 foot.

Minimum order lengths may be in effect

These materials can be easily used to make shields and covers that are assembled with mechanical fasteners. Easily punched or drilled for installation of grommets, or insertion of sheet metal screws or bolts.

Available with Standard or High Temperature Acrylic PSA

**Silicone Rubber Sheet Rolls – Commercial Grade - Red / Grey / Black**  
**500°F / 260°C: FlameShield™ - High Temperature, Heat & Flame Resistant**  
*Hot process protection*



- Used as a heat resistant pad for hot process work.
- High thermal conductivity.
- High electrical resistance.
- Resistant to weld splatter, grinding sparks, solder drips, brazing.
- Can be used to fabricate large gaskets.
- Durometer of 50 +/- 5%, 60 +/-5% or 70 +/-5%. Elongation 350%. Tensile 725 psi. Color is Oxide-Red.
- Meets MIL-STD A-A-59588 Class 2A & 2B (ZZ-R-765)

**Silicone Rubber Sheet Rolls – Commercial Grade - Red / Grey / Black**  
**500°F / 260°C: FlameShield™ - High Temperature, Heat & Flame Resistant**  
**Hot process protection**



FlameShield™ high temperature silicone rubber sheet Commercial Grade				
Part Number	Durometer	Roll Size / Wt lbs	Thickness in / mm	Price / linear ft
F-SR50-CG-36-062-X-Y	30	36" x 50' / 61	1/16" / .062 / 1.57	\$ 22.23
F-SR50-CG-36-093-X-Y	50	36" x 50' / 92	3/32 / .093 / 2.36	\$ 33.20
F-SR50-CG-36-125-X-Y	50	36" x 50' / 122	1/8" / .125 / 3.18	\$ 44.86
F-SR50-CG-36-250-X-Y	50	36" x 50' / 244	1/4" / .250 / 6.35	\$ 89.70
F-SR50-CG-48-250-X-Y	50	48" x 50' / 326	1/4" / .250 / 6.35	\$ 120.90
F-SR60-CG-36-062-X-Y	40	36" x 50' / 61	1/16" / .062 / 1.57	\$ 22.23
F-SR60-CG-36-125-X-Y	60	36" x 50' / 122	1/8" / .125 / 3.18	\$ 44.86
F-SR60-CG-36-250-X-Y	60	36" x 50' / 244	1/4" / .250 / 6.35	\$ 89.70
F-SR60-CG-48-062-X-Y	60	48" x 50' / 82	1/16" / .062 / 1.57	\$ 29.56
F-SR60-CG-48-125-X-Y	60	48" x 50' / 163	1/8" / .125 / 3.18	\$ 59.66
F-SR60-CG-48-250-X-Y	60	48" x 50' / 326	1/4" / .250 / 6.35	\$ 120.90
F-SR70-CG-36-062-X-Y	70	36" x 50' / 61	1/16" / .062 / 1.57	\$ 22.23
F-SR70-CG-36-093-X-Y	70	36" x 50' / 92	3/32 / .093 / 2.36	\$ 33.20
F-SR70-CG-36-125-X-Y	70	36" x 50' / 122	1/8" / .125 / 3.18	\$ 44.86
F-SR70-CG-36-250-X-Y	70	36" x 50' / 244	1/4" / .250 / 6.35	\$ 89.70
F-SR70-CG-48-062-X-Y	70	48" x 50' / 82	1/16" / .062 / 1.57	\$ 29.56
F-SR70-CG-48-093-X-Y	70	48" x 50' / 122	3/32 / .093 / 2.36	\$ 44.13
F-SR70-CG-48-125-X-Y	70	48" x 50' / 163	1/8" / .125 / 3.18	\$ 59.66
F-SR70-CG-48-250-X-Y	70	48" x 50' / 326	1/4" / .250 / 6.35	\$ 120.90

- For the "X" value, Specify "F" for by-the-foot length, or "R" for full 50 foot.
- For the "Y" value, Specify "R" for Red, or "G" for grey, or "B" for black.

Available by the linear foot. Full roll (50 feet) purchase is -10% pricing  
 This item is normally stock

These materials can be easily used to make shields and covers that are assembled with mechanical fasteners. Easily punched or drilled for installation of grommets, or insertion of sheet metal screws or bolts.



**Silicone Rubber Sheet Rolls – FDA Food Grade - White**  
**500°F / 260°C: FlameShield™ - High Temperature, Heat & Flame Resistant**  
**Hot process protection**



- Used as a heat resistant pad for hot process work.
- High thermal conductivity.
- High electrical resistance.
- Resistant to weld splatter, grinding sparks, solder drips, brazing.
- Can be used to fabricate large gaskets.
- Durometer of 50 +/- 5%, 60 +/-5% or 70 +/- 5%. Elongation 350%. Tensile 725 psi. Color is Oxide-Red.
- Meets MIL-STD A-A-59588 Class 2A & 2B (ZZ-R-765)

<b>FlameShield™ high temperature silicone rubber sheet FDA - Food Grade</b>				
<b>Part Number</b>	<b>Durometer</b>	<b>Roll Size / Wt lbs</b>	<b>Thickness in / mm</b>	<b>Price / linear ft</b>
F-SR50-FDA-36-062-X	30	36" x 50' / 61	1/16" / .062 / 1.57	\$ 22.23
F-SR50-FDA-36-093-X	50	36" x 50' / 92	3/32 / .093 / 2.36	\$ 33.20
F-SR50-FDA-36-125-X	50	36" x 50' / 122	1/8" / .125 / 3.18	\$ 44.86
F-SR50-FDA-36-250-X	50	36" x 50' / 244	1/4" / .250 / 6.35	\$ 89.70
F-SR50-FDA-48-250-X	50	48" x 50' / 326	1/4" / .250 / 6.35	\$ 120.90
F-SR60-FDA-36-062-X	40	36" x 50' / 61	1/16" / .062 / 1.57	\$ 22.23
F-SR60-FDA-36-125-X	60	36" x 50' / 122	1/8" / .125 / 3.18	\$ 44.86
F-SR60-FDA-36-250-X	60	36" x 50' / 244	1/4" / .250 / 6.35	\$ 89.70
F-SR60-FDA-48-062-X	60	48" x 50' / 82	1/16" / .062 / 1.57	\$ 29.56
F-SR60-FDA-48-125-X	60	48" x 50' / 163	1/8" / .125 / 3.18	\$ 59.66
F-SR60-FDA-48-250-X	60	48" x 50' / 326	1/4" / .250 / 6.35	\$ 120.90
F-SR70-FDA-36-062-X	70	36" x 50' / 61	1/16" / .062 / 1.57	\$ 22.23
F-SR70-FDA-36-093-X	70	36" x 50' / 92	3/32 / .093 / 2.36	\$ 33.20
F-SR70-FDA-36-125-X	70	36" x 50' / 122	1/8" / .125 / 3.18	\$ 44.86
F-SR70-FDA-36-250-X	70	36" x 50' / 244	1/4" / .250 / 6.35	\$ 89.70
F-SR70-FDA-48-062-X	70	48" x 50' / 82	1/16" / .062 / 1.57	\$ 29.56
F-SR70-FDA-48-093-X	70	48" x 50' / 122	3/32 / .093 / 2.36	\$ 44.13
F-SR70-FDA-48-125-X	70	48" x 50' / 163	1/8" / .125 / 3.18	\$ 59.66
F-SR70-FDA-48-250-X	70	48" x 50' / 326	1/4" / .250 / 6.35	\$ 120.90

- For the "X" value, Specify "F" for by-the-foot length, or "R" for full 50 foot.

Available by the linear foot. Full roll (50 feet) purchase is -10% pricing  
This item is normally stock

These materials can be easily used to make shields and covers that are assembled with mechanical fasteners. Easily punched or drilled for installation of grommets, or insertion of sheet metal screws or bolts.

## Silicone Rubber Sheet Rolls – Medical Grade

### 500°F / 260°C: FlameShield™ - High Temperature, Heat & Flame Resistant

#### Hot process protection



- Used as a heat resistant pad for hot process work.
- High thermal conductivity.
- High electrical resistance.
- Resistant to weld splatter, grinding sparks, solder drips, brazing.
- Can be used to fabricate large gaskets.
- Durometer of 50 +/- 5%, 60 +/-5% or 70 +/- 5%. Elongation 350%. Tensile 725 psi. Color is Oxide-Red.
- Meets MIL-STD A-A-59588 Class 2A & 2B (ZZ-R-765)

FlameShield™ high temperature silicone rubber sheet Medical Grade				
Part Number	Durometer	Roll Size / Wt lbs	Thickness in / mm	Price / linear ft
F-SR50-MG-36-062-X	30	36" x 50' / 61	1/16" / .062 / 1.57	\$ 22.23
F-SR50-MG-36-093-X	50	36" x 50' / 92	3/32 / .093 / 2.36	\$ 33.20
F-SR50-MG-36-125-X	50	36" x 50' / 122	1/8" / .125 / 3.18	\$ 44.86
F-SR50-MG-36-250-X	50	36" x 50' / 244	1/4" / .250 / 6.35	\$ 89.70
F-SR50-MG-48-250-X	50	48" x 50' / 326	1/4" / .250 / 6.35	\$ 120.90
F-SR60-MG-36-062-X	40	36" x 50' / 61	1/16" / .062 / 1.57	\$ 22.23
F-SR60-MG-36-125-X	60	36" x 50' / 122	1/8" / .125 / 3.18	\$ 44.86
F-SR60-MG-36-250-X	60	36" x 50' / 244	1/4" / .250 / 6.35	\$ 89.70
F-SR60-MG-48-062-X	60	48" x 50' / 82	1/16" / .062 / 1.57	\$ 29.56
F-SR60-MG-48-125-X	60	48" x 50' / 163	1/8" / .125 / 3.18	\$ 59.66
F-SR60-MG-48-250-X	60	48" x 50' / 326	1/4" / .250 / 6.35	\$ 120.90
F-SR70-MG-36-062-X	70	36" x 50' / 61	1/16" / .062 / 1.57	\$ 22.23
F-SR70-MG-36-093-X	70	36" x 50' / 92	3/32 / .093 / 2.36	\$ 33.20
F-SR70-MG-36-125-X	70	36" x 50' / 122	1/8" / .125 / 3.18	\$ 44.86
F-SR70-MG-36-250-X	70	36" x 50' / 244	1/4" / .250 / 6.35	\$ 89.70
F-SR70-MG-48-062-X	70	48" x 50' / 82	1/16" / .062 / 1.57	\$ 29.56
F-SR70-MG-48-093-X	70	48" x 50' / 122	3/32 / .093 / 2.36	\$ 44.13
F-SR70-MG-48-125-X	70	48" x 50' / 163	1/8" / .125 / 3.18	\$ 59.66
F-SR70-MG-48-250-X	70	48" x 50' / 326	1/4" / .250 / 6.35	\$ 120.90

- For the "X" value, Specify "F" for by-the-foot length, or "R" for full 50 foot.

Available by the linear foot. Full roll (50 feet) purchase is -10% pricing  
This item is normally stock

These materials can be easily used to make shields and covers that are assembled with mechanical fasteners. Easily punched or drilled for installation of grommets, or insertion of sheet metal screws or bolts.

## Silicone Rubber Sheet Rolls – Translucent

### 500°F / 260°C: FlameShield™ - High Temperature, Heat & Flame Resistant

Hot process protection



- Used as a heat resistant pad for hot process work.
- High thermal conductivity.
- High electrical resistance.
- Resistant to weld splatter, grinding sparks, solder drips, brazing.
- Can be used to fabricate large gaskets.
- Durometer of 50 +/- 5%, 60 +/-5% or 70 +/- 5%. Elongation 350%. Tensile 725 psi. Color is Oxide-Red.
- Meets MIL-STD A-A-59588 Class 2A & 2B (ZZ-R-765)

FlameShield™ high temperature silicone rubber sheet Translucent				
Part Number	Durometer	Roll Size / Wt lbs	Thickness in / mm	Price / linear ft
F-SR50-TL-36-062-X	30	36" x 50' / 61	1/16" / .062 / 1.57	\$ 22.23
F-SR50-TL-36-093-X	50	36" x 50' / 92	3/32 / .093 / 2.36	\$ 33.20
F-SR50-TL-36-125-X	50	36" x 50' / 122	1/8" / .125 / 3.18	\$ 44.86
F-SR50-TL-36-250-X	50	36" x 50' / 244	1/4" / .250 / 6.35	\$ 89.70
F-SR50-TL-48-250-X	50	48" x 50' / 326	1/4" / .250 / 6.35	\$ 120.90
F-SR60-TL-36-062-X	40	36" x 50' / 61	1/16" / .062 / 1.57	\$ 22.23
F-SR60-TL-36-125-X	60	36" x 50' / 122	1/8" / .125 / 3.18	\$ 44.86
F-SR60-TL-36-250-X	60	36" x 50' / 244	1/4" / .250 / 6.35	\$ 89.70
F-SR60-TL-48-062-X	60	48" x 50' / 82	1/16" / .062 / 1.57	\$ 29.56
F-SR60-TL-48-125-X	60	48" x 50' / 163	1/8" / .125 / 3.18	\$ 59.66
F-SR60-TL-48-250-X	60	48" x 50' / 326	1/4" / .250 / 6.35	\$ 120.90
F-SR70-TL-36-062-X	70	36" x 50' / 61	1/16" / .062 / 1.57	\$ 22.23
F-SR70-TL-36-093-X	70	36" x 50' / 92	3/32 / .093 / 2.36	\$ 33.20
F-SR70-TL-36-125-X	70	36" x 50' / 122	1/8" / .125 / 3.18	\$ 44.86
F-SR70-TL-36-250-X	70	36" x 50' / 244	1/4" / .250 / 6.35	\$ 89.70
F-SR70-TL-48-062-X	70	48" x 50' / 82	1/16" / .062 / 1.57	\$ 29.56
F-SR70-TL-48-093-X	70	48" x 50' / 122	3/32 / .093 / 2.36	\$ 44.13
F-SR70-TL-48-125-X	70	48" x 50' / 163	1/8" / .125 / 3.18	\$ 59.66
F-SR70-TL-48-250-X	70	48" x 50' / 326	1/4" / .250 / 6.35	\$ 120.90

- For the "X" value, Specify "F" for by-the-foot length, or "R" for full 50 foot.

Available by the linear foot. Full roll (50 feet) purchase is -10% pricing  
This item is normally stock

These materials can be easily used to make shields and covers that are assembled with mechanical fasteners. Easily punched or drilled for installation of grommets, or insertion of sheet metal screws or bolts.

## Silicone Rubber Sheet Rolls – Fluorosilicone

### 500°F / 260°C: FlameShield™ - High Temperature, Heat & Flame Resistant

#### Hot process protection



- Used as a heat resistant pad for hot process work.
- High thermal conductivity.
- High electrical resistance.
- Resistant to weld splatter, grinding sparks, solder drips, brazing.
- Can be used to fabricate large gaskets.
- Durometer of 50 +/- 5%, 60 +/-5% or 70 +/- 5%. Elongation 350%. Tensile 725 psi. Color is Oxide-Red.
- Meets MIL-STD A-A-59588 Class 2A & 2B (ZZ-R-765)

FlameShield™ high temperature silicone rubber sheet Fluorosilicone				
Part Number	Durometer	Roll Size / Wt lbs	Thickness in / mm	Price / linear ft
F-SR50-FL-36-062-X	30	36" x 50' / 61	1/16" / .062 / 1.57	\$ 22.23
F-SR50-FL-36-093-X	50	36" x 50' / 92	3/32 / .093 / 2.36	\$ 33.20
F-SR50-FL-36-125-X	50	36" x 50' / 122	1/8" / .125 / 3.18	\$ 44.86
F-SR50-FL-36-250-X	50	36" x 50' / 244	1/4" / .250 / 6.35	\$ 89.70
F-SR50-FL-48-250-X	50	48" x 50' / 326	1/4" / .250 / 6.35	\$ 120.90
F-SR60-FL-36-062-X	40	36" x 50' / 61	1/16" / .062 / 1.57	\$ 22.23
F-SR60-FL-36-125-X	60	36" x 50' / 122	1/8" / .125 / 3.18	\$ 44.86
F-SR60-FL-36-250-X	60	36" x 50' / 244	1/4" / .250 / 6.35	\$ 89.70
F-SR60-FL-48-062-X	60	48" x 50' / 82	1/16" / .062 / 1.57	\$ 29.56
F-SR60-FL-48-125-X	60	48" x 50' / 163	1/8" / .125 / 3.18	\$ 59.66
F-SR60-FL-48-250-X	60	48" x 50' / 326	1/4" / .250 / 6.35	\$ 120.90
F-SR70-FL-36-062-X	70	36" x 50' / 61	1/16" / .062 / 1.57	\$ 22.23
F-SR70-FL-36-093-X	70	36" x 50' / 92	3/32 / .093 / 2.36	\$ 33.20
F-SR70-FL-36-125-X	70	36" x 50' / 122	1/8" / .125 / 3.18	\$ 44.86
F-SR70-FL-36-250-X	70	36" x 50' / 244	1/4" / .250 / 6.35	\$ 89.70
F-SR70-FL-48-062-X	70	48" x 50' / 82	1/16" / .062 / 1.57	\$ 29.56
F-SR70-FL-48-093-X	70	48" x 50' / 122	3/32 / .093 / 2.36	\$ 44.13
F-SR70-FL-48-125-X	70	48" x 50' / 163	1/8" / .125 / 3.18	\$ 59.66
F-SR70-FL-48-250-X	70	48" x 50' / 326	1/4" / .250 / 6.35	\$ 120.90

- For the "X" value, Specify "F" for by-the-foot length, or "R" for full 50 foot.

Available by the linear foot. Full roll (50 feet) purchase is -10% pricing  
This item is normally stock

These materials can be easily used to make shields and covers that are assembled with mechanical fasteners. Easily punched or drilled for installation of grommets, or insertion of sheet metal screws or bolts.



**Silicone Rubber Sheet Rolls – Electrically Conductive**  
**500°F / 260°C: FlameShield™ - High Temperature, Heat & Flame Resistant**  
*Hot process protection*



- Used as a heat resistant pad for hot process work.
- High thermal conductivity.
- Electrically conductive.
- Resistant to weld splatter, grinding sparks, solder drips, brazing.
- Can be used to fabricate large gaskets.
- Durometer of 50 +/- 5%, 60 +/-5% or 70 +/- 5%. Elongation 350%. Tensile 725 psi. Color is Oxide-Red.
- Meets MIL-STD A-A-59588 Class 2A & 2B (ZZ-R-765)

<b>FlameShield™ high temperature silicone rubber sheet Electrically Conductive</b>				
<b>Part Number</b>	<b>Durometer</b>	<b>Roll Size / Wt lbs</b>	<b>Thickness in / mm</b>	<b>Price / linear ft</b>
F-SR50-EC-36-062-X	30	36" x 50' / 61	1/16" / .062 / 1.57	\$ 22.23
F-SR60-EC-36-062-X	40	36" x 50' / 61	1/16" / .062 / 1.57	\$ 22.23

- For the "X" value, Specify "F" for by-the-foot length, or "R" for full 50 foot.  
 Available by the linear foot. Full roll (50 feet) purchase is -10% pricing  
 This item is normally stock

These materials can be easily used to make shields and covers that are assembled with mechanical fasteners. Easily punched or drilled for installation of grommets, or insertion of sheet metal screws or bolts.



## Silicone Rubber Sheet Rolls – High Strength

### 500°F / 260°C: FlameShield™ - High Temperature, Heat & Flame Resistant

#### Hot process protection



- Used as a heat resistant pad for hot process work.
- High thermal conductivity.
- High electrical resistance.
- Resistant to weld splatter, grinding sparks, solder drips, brazing.
- Can be used to fabricate large gaskets.
- Durometer of 50 +/- 5%, 60 +/-5% or 70 +/- 5%. Elongation 350%. Tensile 725 psi. Color is Oxide-Red.
- Meets MIL-STD A-A-59588 Class 2A & 2B (ZZ-R-765)

FlameShield™ high temperature silicone rubber sheet				
Part Number	Durometer	Roll Size / Wt lbs	Thickness in / mm	Price / linear ft
F-SR50-HS-36-062-X	30	36" x 50' / 61	1/16" / .062 / 1.57	\$ 22.23
F-SR50-HS-36-093-X	50	36" x 50' / 92	3/32 / .093 / 2.36	\$ 33.20
F-SR50-HS-36-125-X	50	36" x 50' / 122	1/8" / .125 / 3.18	\$ 44.86
F-SR50-HS-36-250-X	50	36" x 50' / 244	1/4" / .250 / 6.35	\$ 89.70
F-SR50-HS-48-250-X	50	48" x 50' / 326	1/4" / .250 / 6.35	\$ 120.90
F-SR60-HS-36-062-X	40	36" x 50' / 61	1/16" / .062 / 1.57	\$ 22.23
F-SR60-HS-36-125-X	60	36" x 50' / 122	1/8" / .125 / 3.18	\$ 44.86
F-SR60-HS-36-250-X	60	36" x 50' / 244	1/4" / .250 / 6.35	\$ 89.70
F-SR60-HS-48-062-X	60	48" x 50' / 82	1/16" / .062 / 1.57	\$ 29.56
F-SR60-HS-48-125-X	60	48" x 50' / 163	1/8" / .125 / 3.18	\$ 59.66
F-SR60-HS-48-250-X	60	48" x 50' / 326	1/4" / .250 / 6.35	\$ 120.90
F-SR70-HS-36-062-X	70	36" x 50' / 61	1/16" / .062 / 1.57	\$ 22.23
F-SR70-HS-36-093-X	70	36" x 50' / 92	3/32 / .093 / 2.36	\$ 33.20
F-SR70-HS-36-125-X	70	36" x 50' / 122	1/8" / .125 / 3.18	\$ 44.86
F-SR70-HS-36-250-X	70	36" x 50' / 244	1/4" / .250 / 6.35	\$ 89.70
F-SR70-HS-48-062-X	70	48" x 50' / 82	1/16" / .062 / 1.57	\$ 29.56
F-SR70-HS-48-093-X	70	48" x 50' / 122	3/32 / .093 / 2.36	\$ 44.13
F-SR70-HS-48-125-X	70	48" x 50' / 163	1/8" / .125 / 3.18	\$ 59.66
F-SR70-HS-48-250-X	70	48" x 50' / 326	1/4" / .250 / 6.35	\$ 120.90

- For the "X" value, Specify "F" for by-the-foot length, or "R" for full 50 foot.

Available by the linear foot. Full roll (50 feet) purchase is -10% pricing  
This item is normally stock

These materials can be easily used to make shields and covers that are assembled with mechanical fasteners. Easily punched or drilled for installation of grommets, or insertion of sheet metal screws or bolts.

## Silicone Rubber Sheet Rolls – Extreme Low Temperature 500°F / 260°C: FlameShield™ - High Temperature, Heat & Flame Resistant Hot process protection



- Used as a heat resistant pad for hot process work.
- High thermal conductivity.
- High electrical resistance.
- Resistant to weld splatter, grinding sparks, solder drips, brazing.
- Can be used to fabricate large gaskets.
- Durometer of 50 +/- 5%, 60 +/-5% or 70 +/- 5%. Elongation 350%. Tensile 725 psi. Color is Oxide-Red.
- Meets MIL-STD A-A-59588 Class 2A & 2B (ZZ-R-765)

FlameShield™ high temperature silicone rubber sheet				
Part Number	Durometer	Roll Size / Wt lbs	Thickness in / mm	Price / linear ft
F-SR50-LT-36-062-X	30	36" x 50' / 61	1/16" / .062 / 1.57	\$ 22.23
F-SR50-LT-36-093-X	50	36" x 50' / 92	3/32 / .093 / 2.36	\$ 33.20
F-SR50-LT-36-125-X	50	36" x 50' / 122	1/8" / .125 / 3.18	\$ 44.86
F-SR50-LT-36-250-X	50	36" x 50' / 244	1/4" / .250 / 6.35	\$ 89.70
F-SR50-LT-48-250-X	50	48" x 50' / 326	1/4" / .250 / 6.35	\$ 120.90
F-SR60-LT-36-062-X	40	36" x 50' / 61	1/16" / .062 / 1.57	\$ 22.23
F-SR60-LT-36-125-X	60	36" x 50' / 122	1/8" / .125 / 3.18	\$ 44.86
F-SR60-LT-36-250-X	60	36" x 50' / 244	1/4" / .250 / 6.35	\$ 89.70
F-SR60-LT-48-062-X	60	48" x 50' / 82	1/16" / .062 / 1.57	\$ 29.56
F-SR60-LT-48-125-X	60	48" x 50' / 163	1/8" / .125 / 3.18	\$ 59.66
F-SR60-LT-48-250-X	60	48" x 50' / 326	1/4" / .250 / 6.35	\$ 120.90
F-SR70-LT-36-062-X	70	36" x 50' / 61	1/16" / .062 / 1.57	\$ 22.23
F-SR70-LT-36-093-X	70	36" x 50' / 92	3/32 / .093 / 2.36	\$ 33.20
F-SR70-LT-36-125-X	70	36" x 50' / 122	1/8" / .125 / 3.18	\$ 44.86
F-SR70-LT-36-250-X	70	36" x 50' / 244	1/4" / .250 / 6.35	\$ 89.70
F-SR70-LT-48-062-X	70	48" x 50' / 82	1/16" / .062 / 1.57	\$ 29.56
F-SR70-LT-48-093-X	70	48" x 50' / 122	3/32 / .093 / 2.36	\$ 44.13
F-SR70-LT-48-125-X	70	48" x 50' / 163	1/8" / .125 / 3.18	\$ 59.66
F-SR70-LT-48-250-X	70	48" x 50' / 326	1/4" / .250 / 6.35	\$ 120.90

- For the "X" value, Specify "F" for by-the-foot length, or "R" for full 50 foot.

Available by the linear foot. Full roll (50 feet) purchase is -10% pricing  
This item is normally stock

These materials can be easily used to make shields and covers that are assembled with mechanical fasteners. Easily punched or drilled for installation of grommets, or insertion of sheet metal screws or bolts.

## Silicone Rubber Sheet Rolls – Silicone Vacuum Blanket

### 500°F / 260°C: FlameShield™ - High Temperature, Heat & Flame Resistant

#### Hot process protection



- Used as a heat resistant pad for hot process work.
- High thermal conductivity.
- High electrical resistance.
- Resistant to weld splatter, grinding sparks, solder drips, brazing.
- Can be used to fabricate large gaskets.
- Durometer of 50 +/- 5%, 60 +/-5% or 70 +/- 5%. Elongation 350%. Tensile 725 psi. Color is Oxide-Red.
- Meets MIL-STD A-A-59588 Class 2A & 2B (ZZ-R-765)

FlameShield™ high temperature silicone rubber sheet				
Part Number	Durometer	Roll Size / Wt lbs	Thickness in / mm	Price / linear ft
F-SR50-VB-36-062-X	30	36" x 50' / 61	1/16" / .062 / 1.57	\$ 22.23
F-SR50-VB-36-093-X	50	36" x 50' / 92	3/32 / .093 / 2.36	\$ 33.20
F-SR50-VB-36-125-X	50	36" x 50' / 122	1/8" / .125 / 3.18	\$ 44.86
F-SR50-VB-36-250-X	50	36" x 50' / 244	1/4" / .250 / 6.35	\$ 89.70
F-SR50-VB-48-250-X	50	48" x 50' / 326	1/4" / .250 / 6.35	\$ 120.90
F-SR60-VB-36-062-X	40	36" x 50' / 61	1/16" / .062 / 1.57	\$ 22.23
F-SR60-VB-36-125-X	60	36" x 50' / 122	1/8" / .125 / 3.18	\$ 44.86
F-SR60-VB-36-250-X	60	36" x 50' / 244	1/4" / .250 / 6.35	\$ 89.70
F-SR60-VB-48-062-X	60	48" x 50' / 82	1/16" / .062 / 1.57	\$ 29.56
F-SR60-VB-48-125-X	60	48" x 50' / 163	1/8" / .125 / 3.18	\$ 59.66
F-SR60-VB-48-250-X	60	48" x 50' / 326	1/4" / .250 / 6.35	\$ 120.90
F-SR70-VB-36-062-X	70	36" x 50' / 61	1/16" / .062 / 1.57	\$ 22.23
F-SR70-VB-36-093-X	70	36" x 50' / 92	3/32 / .093 / 2.36	\$ 33.20
F-SR70-VB-36-125-X	70	36" x 50' / 122	1/8" / .125 / 3.18	\$ 44.86
F-SR70-VB-36-250-X	70	36" x 50' / 244	1/4" / .250 / 6.35	\$ 89.70
F-SR70-VB-48-062-X	70	48" x 50' / 82	1/16" / .062 / 1.57	\$ 29.56
F-SR70-VB-48-093-X	70	48" x 50' / 122	3/32 / .093 / 2.36	\$ 44.13
F-SR70-VB-48-125-X	70	48" x 50' / 163	1/8" / .125 / 3.18	\$ 59.66
F-SR70-VB--250-X	70	48" x 50' / 326	1/4" / .250 / 6.35	\$ 120.90

- For the "X" value, Specify "F" for by-the-foot length, or "R" for full 50 foot.

Available by the linear foot. Full roll (50 feet) purchase is -10% pricing  
This item is normally stock

These materials can be easily used to make shields and covers that are assembled with mechanical fasteners. Easily punched or drilled for installation of grommets, or insertion of sheet metal screws or bolts.

**PSA for application to Silicone Rubber Sheet Rolls**  
**500°F / 260°C: FlameShield™ - High Temperature, Heat & Flame Resistant**  
*Hot process protection*



STANDARD ACRYLIC PSA CONSTRUCTION

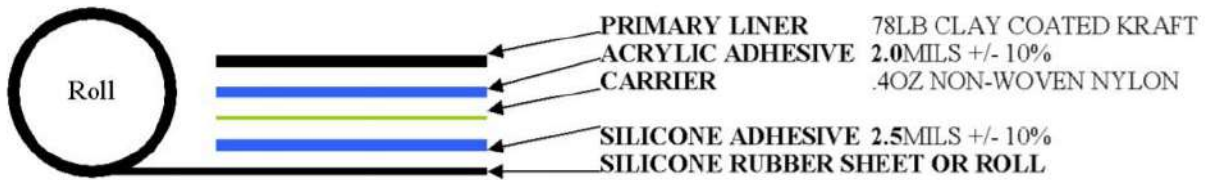



**Thermal, EMI/RFI & Abrasion Protection Materials**

Fax Orders: 610-340-9054 Telephone Orders: 610-906-3549 [orders@abthermal.com](mailto:orders@abthermal.com)

---







**High Temperature, Heat, Flame, Fire, Molten Metal & Weld Splatter Protection Materials**

*Fax Orders: 610-340-9054 Telephone Orders: 610-906-3549 [orders@abthermal.com](mailto:orders@abthermal.com)*

---

---

# Insulation Materials

DeltaMax™ Silicone Sponge Foam Insulation - Closed Cell .....	5-1
PyroTecton™ Meta Aramid Needled Nomex® Insulation Felt .....	5-2
PyroTecton™ Para Aramid Needled Kevlar® Insulation Felt .....	5-3
DeltaMax™ Needled Fiberglass Felt / Batt .....	5-4
InSilMax™ Needled Silica Felt / Batt .....	5-5
InSilMax™ XT Needled Silica Felt / Batt .....	5-6
InSilSafe™ Needled Vitreous Silicate Felt / Batt .....	5-7
InSilPro Non Woven Silica Insulation .....	5-8
Needled Ceramic Fiber Felt / Batt .....	5-9
Rigid Mineral Wool Insulation Board - Marine Approved .....	5-10



High Temperature  
DeltaMax™ Silicone Foam  
Insulation Page 5-1



High Temperature DeltaMax™  
Meta & Para Aramid Insulation Felts  
Page 5-2

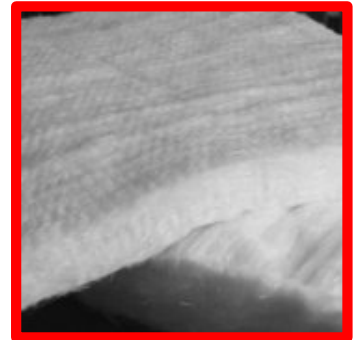

Very High Temperature  
DeltaMax™ Needled  
Fiberglass Insulation Page 5-4

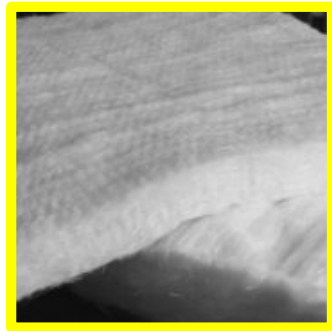

InSiMax™ Extreme Temperature  
Silica Insulation. Page 5-5



InSiMax™ XT Extreme Temperature  
Silica Insulation. Page 5-6



Extreme Temperature  
CerMax™ Fibre Insulation  
Page 5-7



InSiSafe™ XT Extreme Temperature  
Vitreous Silicate Insulation. Page 5-8

**Silicone Sponge Foam - Closed Cell - Roll & Sheet**  
**Soft / Medium / Firm / Extra Firm**  
**Low Thermal Conductivity Insulation**  
**450°F / 232°C: DeltaMax™ High Temperature & Heat Resistant**



- Available in primary thicknesses of:  
0.032" / 0.81mm,  
0.062" / 1.57mm,  
0.093" / 2.36mm,  
0.125" / 3.18mm,  
0.187" / 4.75mm,  
0.250" / 6.35mm,  
0.375" / 9.53mm,  
0.500" / 12.7mm.
- 0.625" / 15.88mm,  
0.750" / 19.05mm,  
and 1.00" / 25.4mm  
thick are laminations  
using acrylic adhesive.
- Standard color is red.  
Other available colors  
are White, Black, Gray.
- Standard grades are  
Soft, Medium & Firm.
- Additional grades of  
Medium FR (Flame  
Retardant) and Extra  
Firm available.

- Water absorption is 5% maximum, typically 1% measured.
- Thermal conductivity 0.110 W/mK.
- Specific Gravity: 0.5
- Tensile Strength: Soft = 90 psi, Medium = 100 psi, Firm = 200 psi, Extra Firm = 300 psi
- Elongation %: Soft = 150, Medium = 200, Firm = 225, Extra Firm = 250
- For thicknesses below .25" the density is .020 lbs/in<sup>3</sup> for Soft, Medium, Medium FR. .028 lbs/in<sup>3</sup> for Firm and .033 lbs/in<sup>3</sup> for Extra Firm. Per ASTM D 1056. For thickness of .25" and thicker, the density is .018 lbs/in<sup>3</sup> for Soft, Medium and Medium FR. .023 lbs/in<sup>3</sup> for Firm and .028 lbs/in<sup>3</sup> for Extra Firm. Per ASTM D 1056
- Compression deflection (25%) for Soft is 5-9 psi, Medium is 6-14 psi, Firm is 12-20 psi, Extra Firm is 17-25 psi.
- Medium Grade is AMS3195. Firm Grade is AMS3196.
- Available slit to any width. Available with PSA adhesive.



**Silicone Sponge Foam - Closed Cell - Roll & Sheet (Continued)**  
**Low Thermal Conductivity Insulation**  
**450°F / 232°C: DeltaMax™ High Temperature & Heat Resistant**



<b>Silicone Sponge Rubber Foam - General Purpose and also UL94 V-0 rated</b>						
<b>Part Number</b>	<b>Thickness in / mm</b>		<b>Tolerance</b>	<b>Roll Length yd / m</b>		<b>Price per yard</b>
IM-SSR-R-032-X-Y	.032	.81	+/- 0.016	40	36	\$ Call
IM-SSR-R-062-X-Y	.062	1.57	+/- 0.030	20	18	\$ Call
IM-SSR-R-093-X-Y	.093	2.36	+/- 0.030	20	18	\$ Call
IM-SSR-R-125-X-Y	.125	3.18	+/- 0.030	20	18	\$ Call
IM-SSR-R-187-X-Y	.187	4.75	+/- 0.030	10	9	\$ Call
IM-SSR-R-250-X-Y	.250	6.35	+0.050 -0.030	10	9	\$ Call
IM-SSR-R-375-X-Y	.375	9.53	+/- .060	5	4.6	\$ Call
IM-SSR-R-500-X-Y	.500	12.7	+/- .060	5	4.6	\$ Call
IM-SSR-R-625-X-Y	.625	15.88	+/- .090	5	4.6	\$ Call
IM-SSR-R-750-X-Y	.750	19.05	+/- .090	5	4.6	\$ Call
IM-SSR-R-1000-X-Y	1.00	25.4	+/- .120	5	4.6	\$ Call

**For the "X" value; specify "S" for Soft, "M" for Medium, "F" for Firm, "X" for Extra Firm or "FR" for Medium with Flame Retardant**

**For the "Y" value specify the length ordering in yards.**

**Roll Width 36" / 91cm - Roll width to 48" / 121 cm available**

**Pricing varies due to raw material fluctuations - Please Call**

**Low Minimums - Typically 1 to 3 yards**

## Meta Aramid Nomex® Insulation Felt 450°F / 230°C PyroTection™ High Temperature Insulation and Protection Heat Resistant Nomex®



- Can be used as an insulation.
- Can be used for filtration.
- Can be as a protection pad in hot processes to prevent marking of products.
- Coatings and PSA's available.
- Resin impregnated available to increase stiffness.
- Roll lengths up to 100metres / 328 feet available on thinner materials. Shorter roll length on thicker materials.

These needed pads can be used as insulation or protection in hot processes to prevent marking of products as they exit various drying/curing ovens.

PyroTection™ Felts - High Temperature & Flame Resistant Nomex®								
230°C / 450°F Operating Temperature - 400°C / 750°C decomposition temperature								
Part Number	Thickness in / mm		Weight oz/yd <sup>2</sup> / g/m <sup>2</sup>		Roll Width in / cm		Roll Length Yards	Price per yard / metre
Nomex® - color is off white								
IM-N-F-8082-10	.080	2.0	10	339	82	208	109	\$ 45.28
IM-N-F-8082-14	.080	2.0	14	474	82	208		Call
IM-N-F-11082-6.5	.110	2.8	6.5	220	82	208	109	\$ 67.20
IM-N-F-16082-7.5	.160	4.1	7.5	254	82	208		Call
IM-N-F-25082-14	.250	6.3	14	474	82	208		Call
IM-N-F-50072-53	.500	12.7	53	1797	72	182		Call
With Resin Stiffener								
IM-N-F-7082-14R	.070	1.7	14	474	82	208		Call
IM-N-F-11082-15R	.110	2.8	15	508	82	208		Call
IM-N-F-19072-28R	.190	4.8	28	949	72	182	55	\$ 180.37
IM-N-F-30072-53R	.300	7.6	53	1797	72	182	55	\$ 316.15



**Para Aramid Kevlar® Insulation Felt**  
**840°F / 450°C PyroTection™ High Temperature Insulation and Protection**  
**Heat Resistant Kevlar®**



- Can be used as an insulation.
- Can be as a protection pad in hot processes to prevent marking of products.
- Coatings and PSA's available.
- Resin impregnated available to increase stiffness.
- Roll lengths up to 100metres / 328 feet available on thinner materials. Shorter roll length on thicker materials.

These needed pads can be used as insulation or protection in hot processes to prevent marking of products as they exit various drying/curing ovens.

<b>PyroTection™ Felts - High Temperature &amp; Flame Resistant</b> <b>Kevlar® / Kevlar-Nomex Blend / Kevlar-Polyester Layered</b> 450°C / 840°F Operating Temperature - 525°C / 975°C decomposition temperature								
Part Number	Thickness in / mm		Weight oz/yd <sup>2</sup> / g/m <sup>2</sup>		Roll Width in / cm		Roll Length yards	Price per yard
Kevlar® - color is yellow								
IM-K-F-0440-3.2	.04	1.0	3.2	108	40	101		Call
IM-K-F-0563-5.5	.05	1.3	5.5	186	63	160	109	\$ 40.23
Kevlar - Nomex Blend								
IM-K/N-F-16066-32	.16	4.1	32	1084	66	167	109	\$ 192.26
With Resin Stiffener								
IM-K-F-19083-38R	.190	4.8	38	1288	83	210	109	\$ 416.27
IM-K-F-48079-95R	.480	12.2	95	3221	79	200	44	\$ 1146.20

**Needed Fiberglass Insulation Felt / Matt / Batt**  
**1200°F / 648°C: DeltaMax™ Very High Temperature, Heat and Flame Resistant**  
**Premium Grade**



- Excellent insulation for sandwiching between front and rear (hot and cold side) layers of blankets & curtains.
- Non-flammable.
- Conforms to MIL-I-16411 Type II.
- Meets US Coast Guard 164.009 for incombustible materials.
- Meets MIL-I-24244 for low corrosiveness.
- Thermal conductivity of .43 at 500°F and .53 at 649°F.
- NSN 5640-00-173-6591

1200°F / 648°C continuous rating, high insulation value

Needed fiberglass insulation felt / matt / batt is manufactured from 100% non-woven E-type fiberglass textile fibers. It is used in a variety of applications and specifically designed for use in aerospace, automotive, construction and industrial applications due to its low corrosiveness (meeting MIL-I-24244).

Used extensively in the production of removable pads for welding stress relieving, furnace and oven wall gap insulation, removable pipe insulation, gas and steam turbine power generating equipment blankets, etc.

<b>Very High Temperature, Heat and Flame Resistant Needed Fiberglass Insulation Felt / Matt / Batt: Premium Grade</b>									
Part Number	Thickness		Density		Roll Width		Roll Length		Price per Yard / Metre
	in	mm	lbs/ft <sup>3</sup>	kg/m <sup>3</sup>	in	cm	ft	m	
IM-FG-NEEDED-0.25	¼	7	9	144	60	152	150	45.7	\$ 25.20 / \$ 27.47
IM-FG-NEEDED-0.50	½	13	9	144	60	152	75	22.8	\$ 35.40 / \$ 38.59
IM-FG-NEEDED-0.75	¾	19	11	176	60	152	45	13.7	\$ 42.69 / \$ 46.67
IM-FG-NEEDED-1.00	1	25	11	176	60	152	45	13.7	\$ 49.98 / \$ 54.48

Weight: 0.25 = 3oz/ft<sup>2</sup>; 0.50 = 6oz/ft<sup>2</sup>; 0.75 = 12oz/ft<sup>2</sup>; 1.00 = 15oz/ft<sup>2</sup>

**This Product is Available By-The-Yard / Metre**

**Silica Needled Insulation Felt / Matt / Batt - Premium Grade**  
**1800°F / 982°C: InSilMax™ Extreme High Temperature**  
**Heat Flame Resistant**



- An alternative to asbestos and ceramic based insulation materials.
- Highly flexible and minimal shrinkage.
- Melts above 3000°F / 1648°C.
- Produced from an extremely pure base fiber (SiO<sub>2</sub>) and can be used at 2000°F / 1093°C continuously with excursions to 3000°F / 1650°C.

This Insulation is a needled blanket manufactured from amorphous silica. This material is an excellent alternative to Refractory Ceramic Fiber (RCF) or asbestos.

It is used in a variety of applications and specifically designed for use in aerospace, automotive, construction and industrial applications. Specific applications include: removable pads, furnace and oven insulation, pipe insulation, power generating equipment plus many more.

InSilMax™ Extreme High Temperature Heat & Flame Resistant Insulation									
Part Number	Thickness in / mm		Density lbs/ft <sup>3</sup> / kg/m <sup>3</sup>		Roll Width in / cm		Roll Length ft / m		Price per roll
IM-S-NEEDED-M003-02	1/8	3	8	144	36	91	130	39	\$ 1437.00
IM-S-NEEDED-M007-04	¼	7	10	180	36	91	99	30	\$ 1738.00
IM-S-NEEDED-M013-08	½	13	10	180	36	91	49	15	\$ 1732.00
IM-S-NEEDED-M025-16	1	25	10	180	36	91	25	7.6	\$ 1761.40

**PRICING NOTE:** DUE TO VOLATILITY IN RAW MATERIAL COSTS THE PRICING ON THIS PRODUCT MAY INCUR A SURCAHRGE AT TIME OF ORDERING

**This Product is NOT Available By-The-Foot – Full Roll Only**



**Silica Insulation Felt / Matt / Batt - Premium High Purity**  
**2000°F / 1093°C: InSilMax™ XT Extreme High Temperature**  
**Heat Flame Resistant**



- An alternative to asbestos and ceramic based insulation materials.
- Highly flexible and minimal shrinkage.
- Melts above 3000°F / 1648°C.
- Produced from an extremely pure base fiber (SiO<sub>2</sub>) and can be used at 2000°F / 1093°C continuously with excursions to 3000°F / 1650°C.
- Shot-free. 6-micron diameter fibers for low skin irritation during handling.
- High re-use cycles of 25-35 for customers using this product for stress relief processes.

This Insulation is a needled blanket manufactured from amorphous silica. This material is an excellent alternative to Refractory Ceramic Fiber (RCF) or asbestos.

It is used in a variety of applications and specifically designed for use in aerospace, automotive, construction and industrial applications. Specific applications include: removable pads, furnace and oven insulation, pipe insulation, power generating equipment plus many more.

InSilMax™ XT Extreme High Temperature Heat & Flame Resistant Insulation									
Part Number	Thickness		Density		Roll Width		Roll Length		Price per roll
	in	mm	lbs/ft <sup>3</sup>	kg/m <sup>3</sup>	in	cm	ft	m	
IM-S-XT-N-M003-02	1/8	3	8	144	36	91	130	39	\$ 1556.00
IM-S-XT-N-M007-04	¼	7	10	180	36	91	99	30	\$ 1910.00
IM-S-XT-N-M013-08	½	13	10	180	36	91	49	15	\$ 1903.20
IM-S-XT-N-M025-16	1	25	10	180	36	91	33	7.6	\$ 1937.50

**PRICING NOTE:** DUE TO VOLATILITY IN RAW MATERIAL COSTS THE PRICING ON THIS PRODUCT MAY INCUR A SURCHARGE AT TIME OF ORDERING

**This Product is NOT Available By-The-Foot – Full Roll Only**



**Vitreous Silicate Insulation Felt / Matt / Batt**  
**1800°F / 982°C: InSilSafe™ Extreme High Temperature Heat Flame Resistant**



- Bio-soluble, organic free, vitreous silicate mineral fibre.
- An alternative to asbestos, silica and ceramic based insulation materials.
- Highly flexible and minimal shrinkage.
- Melts above 3000°F / 1648°C.
- Produced from a mineral fibre that can be used at 1800°F / 982°C continuously with excursions to 3000°F / 1650°C.

This Insulation is a needled blanket manufactured from Vitreous Silicate Fibre. This material is an excellent alternative to Refractory Ceramic Fiber (RCF), asbestos or Silica.

It is used in a variety of applications and specifically designed for use in aerospace, automotive, construction and industrial applications. Specific applications include: removable pads, furnace and oven insulation, pipe insulation, power generating equipment plus many more.

<b>InSilSafe™ Extreme High Temperature Heat &amp; Flame Resistant Insulation</b>									
<b>Part Number</b>	<b>Thickness in / mm</b>		<b>Density lbs/ft<sup>3</sup> / kg/m<sup>3</sup></b>		<b>Roll Width in / cm</b>		<b>Roll Length ft / m</b>		<b>Price per roll</b>
IM-ISS-24-M007-04	¼	7	10	180	24	91	100	30	\$ 223.00
IM-ISS-24-M013-08	½	13	10	180	24	91	50	15	\$ 175.67
IM-ISS-24-M025-16	1	25	10	180	24	91	25	7.6	\$ 183.49
IM-ISS-48-M007-04	¼	7	10	180	48	121	100	30	\$ 447.33
IM-ISS-48-M013-08	½	13	10	180	48	121	50	15	\$ 351.33
IM-ISS-48-M025-16	1	25	10	180	48	121	25	7.6	\$ 366.98
IM-ISS-54-M007-04	¼	7	10	180	54	137	100	30	\$ 504.00
IM-ISS-54-M013-08	½	13	10	180	54	137	50	15	\$ 396.00
IM-ISS-54-M025-16	1	25	10	180	54	137	25	7.6	\$ 414.00
IM-ISS-60-M007-04	¼	7	10	180	60	152	100	30	\$ 559.66
IM-ISS-60-M013-08	½	13	10	180	60	152	50	15	\$ 439.71
IM-ISS-60-M025-16	1	25	10	180	60	152	25	7.6	\$ 459.45



**Non-Woven Silica Insulation Felt**  
**2000°F / 1093°C: InSilPro™ Extreme High Temperature**  
**Heat Flame Resistant**

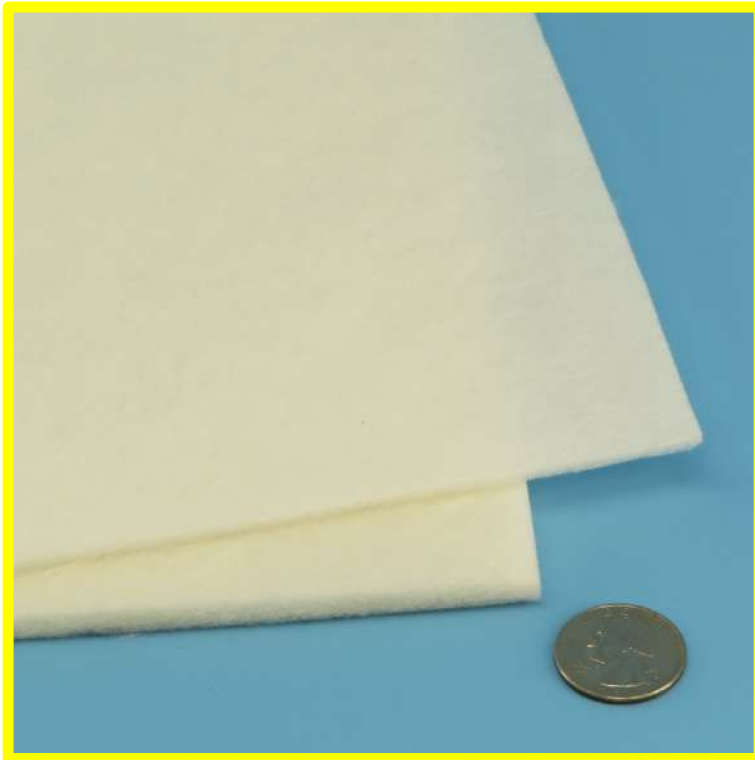

- An alternative to asbestos and ceramic based insulation materials.
- Highly flexible and minimal shrinkage.
- Melts above 3000°F / 1648°C.
- Produced from an extremely pure base fiber (SiO<sub>2</sub>) and can be used at 2000°F / 1093°C continuously with excursions to 3000°F / 1650°C.
- Flat orientation thermal conductivity of 0.18 at 200°F; 0.20 at 400°F; 0.23 at 600°F; 0.26 at 800°F.

This Insulation is a non-woven blanket manufactured from amorphous silica. An excellent alternative to Refractory Ceramic Fiber (RCF) or asbestos.

Flexible, but with handling stiffness - may be cut to size to fit complex fitting areas.

May also be encapsulated in facing materials and other fabrics. It is used in a variety of applications and specifically designed for use in aerospace, automotive, construction and industrial applications. Specific applications include: removable pads, furnace and oven insulation, pipe insulation, power generating equipment plus many more.

InSilPro™ Extreme High Temperature Heat & Flame Resistant Non-Woven Insulation										
Part Number	Thickness in / mm		Density lbs/ft <sup>3</sup> / kg/m <sup>3</sup>		Roll Width in / cm		Roll Length ft / m		Price per roll	Price per Yard
IM-S-NW-05-X-Y	7/32	5	8	144	36	91	50	15	\$ 1925.00	\$ 231.00
IM-S-NW-05-X-Y	7/32	5	8	144	60	152	50	15	\$ 3208.33	\$ 385.00
IM-S-NW-10-X-Y	13/32	10	8	144	36	91	25	7.5	\$ 1487.49	\$ 356.99
IM-S-NW-10-X-Y	13/32	10	8	144	60	152	25	7.6	\$ 2479.17	\$ 594.99

For the "X" Value, specify 36 for 36" roll width and 60 for 60" roll width.  
For the Y value, specify R for full roll or number of linear yards for cut length

## Ceramic Fiber Insulation: Premium Grade 2000°F / 1093°C: CerMax™ Extreme Temperature



- An alternative to asbestos based insulation materials.
- Highly flexible and minimal shrinkage.
- Melts above 3000°F / 1648°C.
- Produced from an extremely pure base fiber (SiO<sub>2</sub>) and can be used at 2000°F / 1093°C continuously with excursions to 3000°F / 1650°C.
- This ceramic fiber insulation is a needled blanket manufactured from ceramic fiber and is an excellent alternative or replacement for asbestos.

It is used in a variety of applications and specifically designed for use in aerospace, automotive, construction and industrial applications. Specific applications include: removable pads, furnace and oven insulation, pipe insulation, power generating equipment plus many more.

CerMax Extreme High Temperature +Plus, Heat & Flame Resistant Ceramic Fiber Insulation									
Part Number	Thickness in / mm		Density lbs/ft <sup>3</sup> / kg/m <sup>3</sup>		Roll Width in / cm		Roll Length ft / m		Price per roll
IM-C-6-8-24*	.50	13	6	96	24	60	25	7.6	\$ 163.33
IM-C-6-8-48	.50	13	6	96	48	121	25	7.6	\$ 163.33
IM-C-8-8-24*	.50	13	8	128	24	60	25	7.6	\$ 183.33
IM-C-8-8-48	.50	13	8	128	48	121	25	7.6	\$ 183.33
IM-C-6-16-24	1	25	6	96	24	60	25	7.6	\$ 161.67
IM-C-6-16-48	1	25	6	96	48	121	25	7.6	\$ 323.33
IM-C-8-16-24	1	25	8	128	24	60	25	7.6	\$ 180.00
IM-C-8-16-48	1	25	8	128	48	121	25	7.6	\$ 360.00
IM-C-6-32-24	2	51	6	96	24	60	12.5	3.8	\$ 160.83
IM-C-6-32-48	2	51	6	96	48	121	12.5	3.8	\$ 321.67
IM-C-8-32-24	2	51	8	128	24	60	12.5	3.8	\$ 176.67
IM-C-8-32-48	2	51	8	128	48	121	12.5	3.8	\$ 356.67
IM-C-8-16-02**	1	25	8	128	2	5	25	7.6	\$ 198.33 / box
IM-C-8-16-03***	1	25	8	128	3	7.6	25	7.6	\$ 198.33 / box

\* Minimum order 2 rolls \*\* 12 rolls per box / \*\*\* 8 rolls per box

Thermal Conductivity: BTU•in./hr•ft<sup>2</sup>•°F (w/mK)

8 LB Density: @500°F (260°C) 0.44 (0.06); @1000°F (538°C) 0.87 (0.12); @1500°F (816°C) 1.45 (0.21)  
@1800°F (982°C) 1.83 (0.26); @2000°F (1093°C) 2.09 (0.30)

6 LB Density: @500°F (260°C) 0.47 (0.07); @1000°F (538°C) 1.01 (0.15); @1500°F (816°C) 1.73 (0.25)  
@1800°F (982°C) 2.19 (0.32)

## Rigid Mineral Wool Insulation Board - Marine Approved

- For Decks and Bulkheads requiring up to A-60 rating
- US Coast Guard / Transport Canada / Lloyds Register Approved
- Meets latest IMO 2010 FTP Code

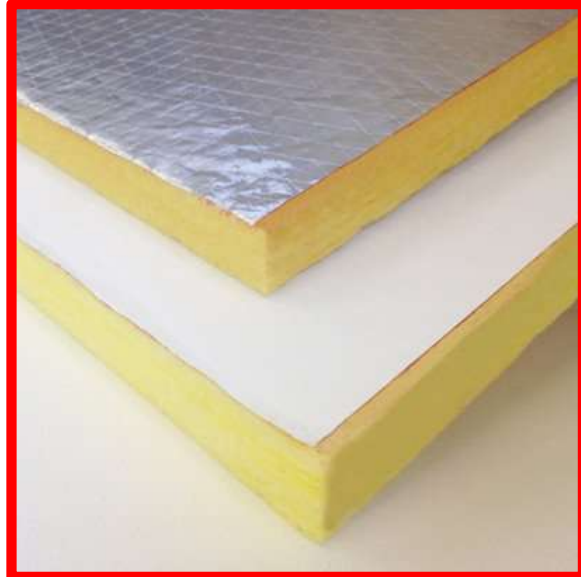

- Suitable for A-30 Steel Bulkhead, A-30 Steel Deck (30 minute rating), A-60 Steel Bulkhead, A-60 Steel Bulkhead (restricted) and A-60 Steel Deck (60 minute rating).
- Non combustible and fire resistant.
- Hydrophobic.
- Reinforced aluminum foil facing on one side. Also available plain (no facing) or with white fiberglass cloth one side.
- 6 lb/ ft<sup>3</sup> density.
- Operating temperature up to 1200°F / 650°C and withstanding flame exposure to 2150°F / 1177°C without melting.

- Flame spread Index = 0, Smoke development index = 0. ASTM E84 (UL 723), CAN/ULC S102
- Thermal resistance: R-value/inch 75°F: 4.1 hr.ft<sup>2</sup>/BTU (0.72m<sup>2</sup>K/W)
- Thermal conductivity: .24 (BTU.in/hr.ft<sup>2</sup>.°F) at 75°F
- Water absorption: <1% Weight
- Suitable for steel pin/metal fastener studs or wire mesh support installation. Easily cut to size.

Mineral Wool Insulation Board - Aluminum Foil Faced - Marine Approved								
Part Number	Thickness		Density	Board Width		Board Length		Price per Panel
	in	mm		in	cm	in	cm	
IM-MWR-AL--50	2"	51	6 lb/ft <sup>2</sup>	24	60.9	48	121.8	\$ 105.00

US Coast Guard Certificate of Approval: 164.107/16/0, 164.107/17/0, 164.109/26/0, 164.112/142/0

Transport Canada Certificate of Approval: LRTC 10-60002, LRTC 10-60001, LRTC 10-60004

Lloyds Register Certificate of Approval: SAS F090281, SAS F090280, SAS F090283





**High Temperature, Heat, Flame, Fire, Molten Metal & Weld Splatter Protection Materials**

*Fax Orders: 610-340-9054 Telephone Orders: 610-906-3549 orders@abthermal.com*

---

---

# Abrasion Protection & Organizational Wire Bundling Sleeve, Spiral Wrap and Shrink Tubing

Nylon Abrasion Resistant Braided Sleeve - .020 monofilament .....	6-1
Nylon Abrasion Resistant Braided Sleeve - .050 monofilament .....	6-2
Nylon Abrasion Resistant Braided Sleeve, woven .....	6-3
Nylon Abrasion Protection Sleeve A-A-59301 & MIL-C-572 .....	6-4
Nylon Abrasion Protection Sleeve A-A-59301 & MIL-C-572: Heavy Wall .....	6-5
Heavy Wall Hi-Flex, .045 Wall .....	6-6
Heavy Wall Pro Hi-Flex, .080 Wall .....	6-7
Nylon 600 Denier with PVC Light Duty Abrasion & Wear Protection Sleeve with Hook Loop Closure .....	6-8
Nylon 1050 Denier with PU Coating Light Duty Abrasion & Wear Protection Sleeve with Hook Loop Closure .....	6-10
Nylon 1000 Denier with PU Coating Medium Duty Abrasion & Wear Protection Sleeve with Hook Loop Closure .....	6-12
Nylon 1500 Denier with PVC Heavy Duty Abrasion & Wear Protection Sleeve with Hook Loop Closure .....	6-14
Nylon with Neoprene Coating Welding & Abrasion Protection Sleeve with Velcro .....	6-16
Fiberglass with Neoprene Coating Welding & Abrasion Protection Sleeve with Velcro .....	6-18
Nylon HD Abrasion Protection Sleeve with Velcro Hook Loop closure – Custom Size .....	6-20
Nylon with Kevlar lining Hydraulic Blowout & Abrasion Protection Sleeve .....	6-21
SPF Spray Foam Hose Protector Sleeve with Hook & Loop Closure .....	6-22
PET Flexible Wrappable Split Braid Sleeve .....	6-23
Polyester Flexible Wrappable Split Woven Sleeve .....	6-24
Polyester Flexible Wrappable Split Woven Sleeve with Hook One Side .....	6-25
Braided PET 150% Expandable Sleeve .....	6-26
Cinch and Hanging Straps .....	6-27

## Spiral Wrap

Hard Shell Hose and Cable Protection Spiral Wrap .....	6-28
HDPE Spiral Wrap Hard Shell Hose and Cable Protection .....	6-30
Mine Approved Hard Shell Hose and Cable Protection MSHA IC-271 .....	6-31
Spiral Wrap with Wear Indicating Layer for Hose & Cable Protection .....	6-32
SafetyWrap Spiral Wrap Hose & Cable Protection .....	6-34

## Shrink Tubing

InsulShrink Polyolefin Shrink Tubing, 2:1, 3:1, 4:1 .....	6-36
InsulShrink Polyolefin Dual Wall with Adhesive, 2:1, 3:1, 4:1 .....	6-
InsulShrink Clear PVC, 2:1 .....	6-
InsulShrink Fabric 2:1 .....	6-
InsulShrink FuelResist 2:1 .....	6-
InsulShrink Viton 2:1 Flame Retardant .....	6-
InsulShrink Kynar 2:1 Flame Retardant .....	6-
InsulShrink Shielding 2:1, 3:1, 4:1 Flame Retardant .....	6-
InsulShrink PTFE 2:1 Flame Retardant .....	6-
InsulShrink Glossy 2:1 .....	6-
InsulShrink Hot Fusion Adhesive Tape .....	6-
InsulShrink Heatshrink Kits .....	6-



**High Temperature, Heat, Flame, Fire, Molten Metal & Weld Splatter Protection Materials**

*Fax Orders: 610-340-9054 Telephone Orders: 610-906-3549 [orders@abthermal.com](mailto:orders@abthermal.com)*

---

---





**Abrasion & Wear Resistant Nylon 6-6 Braided Sleeve**  
**.020" Monofilament Construction**  
**Very High Abrasion Resistance for Hose, Wire and Cable Protection**



- Abrasion and wear resistant protection sleeve for hoses, wires and cables.
- Made from 20 mil (.020") monofilament Nylon 6-6 – provides a tight weave and smooth surface resists abrasive wear. Wall thickness .04"
- Expandable for ease of installation. Easily cut to length with heat knife.
- Nylon 6-6 provides excellent UV protection.
- Minimum temperature: -76°F / -60°C. Maximum continuous 302°F / 150°C (MIL-I-23053). Melting temperature 509°F / 265°C.
- 2500 abrasion cycle rated

- Tensile strength - yarn: 19 lbs (ASTM D-2265).



<b>Scuff-Sleeve™ Braided Nylon Expandable Protection Sleeve fabricated from .020" Monofilament elements. Wall thickness .04"</b>				
Part Number	Nominal Size	Range	Spool Size & Price	
			Bulk Spool	Shop Spool
S-NY-APS-ES20-M006-04-X	0.25"	0.25 – 0.50	500 ft / \$ 210.00	100 ft / \$ 52.00
S-NY-APS-ES20-M013-08-X	0.50"	0.50 – 1.00	250 ft / \$ 160.00	100 ft / \$ 72.00
S-NY-APS-ES20-M019-12-X	0.75"	0.75 – 1.25	250 ft / \$ 185.00	50 ft / \$ 47.00
S-NY-APS-ES20-M025-16-X	1.00"	1.00 – 1.50"	250 ft / \$ 220.00	50 ft / \$ 54.00
S-NY-APS-ES20-M032-20-X	1.25"	1.25 – 2.00	250 ft / \$ 240.00	50 ft / \$ 58.00
S-NY-APS-ES20-M044-28-X	1.75"	1.75 – 2.75	100 ft / \$ 130.00	25 ft / \$ 42.50
S-NY-APS-ES20-M057-36-X	2.25"	2.25 – 3.00	100 ft / \$ 172.00	25 ft / \$ 53.00

For the "X" value in the part number: specify "B" for Bulk Spool or "S" for Shop Spool



**Abrasion & Wear Resistant Nylon 6-6 Braided Sleeve**  
**.050 Flattened Monofilament Construction**  
**Extremely high abrasion resistance for Hose, Wire and Cable Protection**



- Abrasion and wear resistant protection sleeve for hoses, wires and cables.
- Made from flattened 50 mil (.050") monofilament nylon 6-6 – provides a tight weave and smooth surface resists abrasive wear.
- Expandable.
- Nylon 6 provides excellent UV protection.
- Easily cut to length with heat knife.
- Minimum temperature: -76°F / -60°C. Maximum continuous 302°F / 150°C (MIL-I-23053). Melting temperature 509°F / 265°C.
- 4400 abrasion cycle rated



<b>Scuff-Sleeve™ Braided Nylon Expandable Protection Sleeve Fabricated from Flattened .050 Monofilament</b>				
Part Number	Nominal Size	Range	Spool Size & Price	
			Bulk Spool	Shop Spool
S-NY-APS-ES50-M013-08-X	0.50"	0.375 – 0.625	500 ft / \$ 365.00	100 ft / \$ 83.00
S-NY-APS-ES50-M019-12-X	0.75"	0.625 – 1.00	250 ft / \$ 230.50	50 ft / \$ 56.10
S-NY-APS-ES50-M025-16-X	1.00"	0.975 – 1.25"	250 ft / \$ 269.00	50 ft / \$ 63.80
S-NY-APS-ES50-M032-20-X	1.25"	1.00 – 1.50	250 ft / \$ 333.50	50 ft / \$ 76.70
S-NY-APS-ES50-M044-28-X	1.75"	1.50 – 2.00	100 ft / \$ 163.00	25 ft / \$ 50.76
S-NY-APS-ES50-M057-36-X	2.00"	1.75 – 2.75	100 ft / \$ 204.60	25 ft / \$ 61.16

For the "X" value in the part number: specify "B" for Bulk Spool or "S" for Shop Spool

## Nylon Abrasion & Wear Protection Sleeve

375°F / 190°C: Abrasion & Wear Resistant Scuff-Sleeve™: for Hose, Wire and Cable Protection



- Abrasion, wear, puncture and cut resistant protection sleeve for hoses, wires and cables.
- Exceeds the new "Line of Sight" operator protection regulations EN982 ISO norm 833 EN414 for hose blowout.
- Ultra tight weave provides leak containment.
- Tight weave and smooth surface resists abrasive wear.
- Less bulky than older cordura sleeves.
- Nylon 6 provides excellent UV protection.
- MSHA approved.
- Exceeds ISO 6945 abrasion standard and ISO 8031 conductivity standard.
- Easily cut to length or cut with heat knife.
- Useable -60°F to +375°F.
- Also available as a Sleeve with Velcro for easy retrofit onto wires, cables or hoses that are already in place.

Helps to organize and bundle hoses and cables, while proving heat resistance to a maximum of 375°F continuous duty, and provides excellent abrasion, scuff and wear resistance.

Scuff-Sleeve™ Nylon Abrasion Protection Sleeve				
Part Number	ID Size			Price per Foot / Metre
	inch	mm	-dash	
S-NY-APS-0.67-M017-11	0.67	17	-11	\$ 1.52 / \$ 4.98
S-NY-APS-0.79-M020-13	0.79	20	-13	\$ 1.57 / \$ 5.15
S-NY-APS-0.91-M023-15	0.91	23	-15	\$ 1.62 / \$ 5.31
S-NY-APS-0.98-M024-16	0.98	24	-16	\$ 1.79 / \$ 5.87
S-NY-APS-1.06-M026-17	1.06	26	-17	\$ 1.88 / \$ 6.17
S-NY-APS-1.22-M030-20	1.22	30	-20	\$ 1.97 / \$ 6.46
S-NY-APS-1.42-M036-23	1.42	36	-23	\$ 2.13 / \$ 6.99
S-NY-APS-1.57-M039-26	1.57	39	-26	\$ 2.28 / \$ 7.48
S-NY-APS-1.73-M043-28	1.73	43	-28	\$ 2.43 / \$ 7.97
S-NY-APS-1.85-M047-30	1.85	47	-30	\$ 2.74 / \$ 8.98
S-NY-APS-2.17-M055-35	2.17	55	-35	\$ 3.16 / \$ 10.37
S-NY-APS-2.36-M059-38	2.36	59	-38	\$ 3.43 / \$ 11.25
S-NY-APS-2.62-M066-42	2.62	66	-42	\$ 3.81 / \$ 12.49
S-NY-APS-2.87-M072-46	2.87	72	-46	\$ 4.67 / \$ 15.32
S-NY-APS-3.14-M080-48	2.95	80	-48	\$ 5.12 / \$ 16.79
S-NY-APS-3.66-M092-59	3.66	92	-59	\$ 5.80 / \$ 19.03
S-NY-APS-3.94-M100-63	3.94	100	-63	\$ 8.20 / \$ 26.89
S-NY-APS-4.41-M112-70	4.41	112	-70	\$ 9.54 / \$ 31.29
S-NY-APS-4.94-M125-80	4.94	125	-80	\$ 9.77 / \$ 32.05
S-NY-APS-5.75-M146-92	5.75	146	-92	\$ 12.62 / \$ 41.39

- Sold in standard lengths of 75, 150 and 300 feet. Other lengths may be available: please enquire. This sleeve is non-expandable – please measure your application carefully.

## Nylon Abrasion & Wear Protection Sleeve – MIL Spec 375°F / 190°C: Abrasion & Wear Resistant Scuff-Sleeve™: for Hose, Wire and Cable Protection – Meets A-A-59301 & MIL-C-572 Specifications



- Abrasion, wear, puncture and cut resistant protection sleeve for hoses, wires and cables.
- Conforms to Commercial Item Description (CID) A-A-59301 and specification MIL-C-572.
- Tight weave and smooth surface resists abrasive wear.
- Nylon 6 provides excellent UV protection.
- Easily cut to length or cut with heat knife.
- Useable -60°F to +375°F.
- For heavier wall see part number S-NY-APS-MILHD.

Helps to organize and bundle hoses and cables, while proving heat resistance to a maximum of 375°F continuous duty, and provides excellent abrasion, puncture, cut, scuff and wear resistance.

Scuff-Sleeve™ Nylon Abrasion & Wear Protection Sleeve Meets A-A-59301 and MIL-C-572 Specifications					
Part Number	ID Size inch / mm / -dash			Wall Thickness	Spool Feet / Spool Price
S-NY-APS-MIL-M002-01	1/16	1.58	-01	.027	500 / \$ 227.87
S-NY-APS-MIL-M003-02	1/8	3.17	-02	.027	500 / \$ 326.63
S-NY-APS-MIL-M005-03	3/16	4.76	-03	.026	500 / \$ 404.25
S-NY-APS-MIL-M006-04	1/4	6.35	-04	.025	500 / \$ 611.25
S-NY-APS-MIL-M008-05	5/16	7.93	-05	.025	500 / \$ 722.13
S-NY-APS-MIL-M010-06	3/8	9.52	-06	.024	250 / \$ 399.69
S-NY-APS-MIL-M011-07	7/16	11.12	-07	.024	250 / \$ 460.25
S-NY-APS-MIL-M013-08	1/2	12.7	-08	.024	250 / \$ 505.06
S-NY-APS-MIL-M016-10	5/8	15.87	-10	.033	150 = \$ 536.70 / 250 = \$ 894.50
S-NY-APS-MIL-M019-12	3/4	19.05	-12	.037	150 = \$ 697.13 / 250 = \$ 1161.87
S-NY-APS-MIL-M022-14	7/8	22.22	-14	.036	100 = \$ 544.27 / 250 = \$ 1360.68
S-NY-APS-MIL-M025-16	1	25.4	-16	.040	100 = \$ 603.90 / 250 = \$ 1509.87
S-NY-APS-MIL-M029-18	1 1/8	28.57	-18	.040	100 = \$ 965.60 / 250 = \$ 2414.00
S-NY-APS-MIL-M032-20	1 1/4	31.75	-20	.048	100 = \$ 1054.35 / 250 = \$ 2635.87
S-NY-APS-MIL-M038-24	1 1/2	38.10	-24	.044	100 / \$ 1221.65
S-NY-APS-MIL-M045-28	1 3/4	44.45	-28	.045	100 / \$ 1311.37
S-NY-APS-MIL-M051-32	2	50.8	-32	.047	100 / \$ 1402.47

- Other lengths may be available: please enquire.
- This sleeve is non-expandable – please measure your application carefully.



## Nylon Abrasion & Wear Protection Sleeve – MIL Spec Heavy Duty 375°F / 190°C: Abrasion & Wear Resistant Scuff-Sleeve™: for Hose, Wire and Cable Protection Meets A-A-59301 & MIL-C-572 Specifications



- Heavy Wall version of S-NY-APS-MIL sleeve.
- Abrasion, wear, puncture and cut resistant protection sleeve for hoses, wires and cables.
- Conforms to A-A-59301 and MIL-C-572 specifications.
- Tight weave and smooth surface resists abrasive wear.
- Nylon 6 provides excellent UV protection.
- Easily cut to length or cut with heat knife.
- Useable -60°F to +375°F.

Helps to organize and bundle hoses and cables, while proving heat resistance to a maximum of 375°F continuous duty, and provides excellent abrasion, scuff and wear resistance.

### Scuff-Sleeve™ Nylon Abrasion & Wear Protection Sleeve – Heavy Wall Meets A-A-59301 and MIL-C-572 Specifications

Part Number	ID Size			Wall Thickness	Spool Feet / Spool Price
	inch	mm	-dash		
S-NY-APS-MILHD-M005-03	3/16	4.76	-03	.029	500 / \$ 548.25
S-NY-APS-MILHD-M006-04	1/4	6.35	-04	.030	500 / \$ 729.37
S-NY-APS-MILHD-M008-05	5/16	7.93	-05	.030	500 / \$ 911.87
S-NY-APS-MILHD-M010-06	3/8	9.52	-06	.032	250 / \$ 533.56
S-NY-APS-MILHD-M011-07	7/16	11.12	-07	.032	250 / \$ 577.12
S-NY-APS-MILHD-M013-08	1/2	12.7	-08	.034	250 / \$ 617.94
S-NY-APS-MILHD-M016-10	5/8	15.87	-10	.038	150 = \$ 613.54 / 250 = \$ 1022.56
S-NY-APS-MILHD-M019-12	3/4	19.05	-12	.042	150 = \$ 742.46 / 250 = \$ 1237.44
S-NY-APS-MILHD-M022-14	7/8	22.22	-14	.042	100 = \$ 661.05 / 250 = \$ 1652.63
S-NY-APS-MILHD-M025-16	1	25.4	-16	.047	100 = \$ 815.85 / 250 = \$ 2039.63

- Other lengths may be available: please enquire.
- This sleeve is non-expandable – please measure your application carefully.



**Nylon Abrasion & Wear Protection Sleeve – Heavy Wall**  
**375°F / 190°C: Abrasion & Wear Resistant Scuff-Sleeve™: Heavy Wall Hi-Flex**  
**Protection for Hose, Wire and Cable Protection**



- .045" Wall Thickness .
- Excellent abrasion & wear resistant sleeve for hoses, wires and cables.
- Conforms to ISO 6945 and MSHA standards. Protection from hose rupture.
- Tight weave and smooth surface resists abrasive wear.
- Nylon 6 provides excellent UV protection.
- Easily cut to length or cut with heat knife.
- Useable -60°F to +375°F.
- High wear resistant sleeve with 3500 abrasion cycle rating

<b>Scuff-Sleeve™ Heavy Wall Hi-Flex Nylon Abrasion &amp; Wear Protection Sleeve – .045" Heavy Wall Thickness</b>					
<b>Part Number</b>	<b>Size inch / mm / -dash</b>			<b>Spool Size &amp; Price</b>	
				<b>Bulk Spool</b>	<b>Shop Spool</b>
S-NY-APS-HD45-0.71-M018-11-X	0.71	18	-11	100 ft / \$ 112.00	50 ft / \$ 66.00
S-NY-APS-HD45-0.83-M021-13-X	0.83	21	-13	100 ft / \$ 117.80	50 ft / \$ 68.90
S-NY-APS-HD45-0.92-M023-15-X	0.92	23	-15	100 ft / \$ 118.80	50 ft / \$ 69.40
S-NY-APS-HD45-1.00-M025-16-X	1.00	25	-16	100 ft / \$ 119.40	50 ft / \$ 69.70
S-NY-APS-HD45-1.13-M029-18-X	1.13	29	-18	100 ft / \$ 128.40	50 ft / \$ 74.20
S-NY-APS-HD45-1.25-M032-20-X	1.25	32	-20	100 ft / \$ 143.20	50 ft / \$ 81.60
S-NY-APS-HD45-1.34-M034-22-X	1.34	34	-22	100 ft / \$ 159.20	50 ft / \$ 89.60
S-NY-APS-HD45-1.59-M040-25-X	1.59	40	-25	100 ft / \$ 167.20	50 ft / \$ 93.60
S-NY-APS-HD45-1.75-M044-28-X	1.75	44	-28	100 ft / \$ 172.00	50 ft / \$ 96.00
S-NY-APS-HD45-2.07-M053-33-X	2.07	53	-33	100 ft / \$ 205.00	50 ft / \$ 112.50
S-NY-APS-HD45-2.38-M060-38-X	2.38	60	-38	100 ft / \$ 256.00	50 ft / \$ 138.00
S-NY-APS-HD45-2.54-M065-41-X	2.54	65	-41	100 ft / \$ 294.00	50 ft / \$ 157.00
S-NY-APS-HD45-2.86-M073-46-X	2.86	73	-46	100 ft / \$ 332.60	50 ft / \$ 176.30
S-NY-APS-HD45-3.34-M085-53-X	3.34	85	-53	50 ft / \$ 186.60	25 ft / \$ 103.16
S-NY-APS-HD45-3.66-M093-59-X	3.66	93	-59	50 ft / \$ 195.80	25 ft / \$ 107.70

For the "X" value in the part number: specify "B" for Bulk Spool or "S" for Shop Spool

This sleeve is non-expandable – please measure your application carefully.

Helps to organize and bundle hoses and cables, while proving heat resistance to a maximum of 375°F continuous duty, and provides excellent abrasion, scuff and wear resistance.

## Nylon Abrasion & Wear Protection Sleeve – Pro Heavy Duty 375°F / 190°C: Abrasion & Wear Resistant Scuff-Sleeve™: PRO Heavy Wall Hi-Flex Protection for Hose, Wire and Cable



- .080" Wall Thickness.
- Excellent abrasion & wear resistant sleeve for hoses, wires and cables.
- Conforms to ISO 6945 and MSHA standards. Protection from hose rupture.
- Tight weave and smooth surface resists abrasive wear. Smooth inner wall surface.
- Nylon 6 provides excellent UV protection.
- Easily cut to length or cut with heat knife.
- Useable -60°F to +375°F.
- Our highest wear resistant sleeve with 13,000 abrasion cycle rating.

Helps to organize and bundle hoses and cables, while proving heat resistance to a maximum of 375°F continuous duty, and provides excellent abrasion, scuff and wear resistance.

Scuff-Sleeve™ PRO Heavy Wall Hi-Flex Nylon Abrasion & Wear Protection Sleeve – .080" Heavy Wall Thickness					
Part Number	Size inch / mm / -dash			Spool Size & Price	
				Bulk Spool	Shop Spool
S-NY-APS-HD80-0.75-M019-12-X	0.75	19	-12	100 ft / \$ 177.40	50 ft / \$ 98.70
S-NY-APS-HD80-0.93-M024-15-X	0.93	24	-15	100 ft / \$ 207.20	50 ft / \$ 113.60
S-NY-APS-HD80-1.13-M029-18-X	1.13	29	-18	100 ft / \$ 250.80	50 ft / \$ 135.40
S-NY-APS-HD80-1.25-M032-20-X	1.25	32	-20	100 ft / \$ 283.00	50 ft / \$ 151.50
S-NY-APS-HD80-1.35-M034-22-X	1.35	34	-22	100 ft / \$ 288.80	50 ft / \$ 154.40
S-NY-APS-HD80-1.43-M036-23-X	1.43	36	-23	100 ft / \$ 315.00	50 ft / \$ 167.50
S-NY-APS-HD80-1.63-M041-26-X	1.63	41	-26	100 ft / \$ 345.00	50 ft / \$ 182.50
S-NY-APS-HD80-1.81-M046-29-X	1.81	46	-29	100 ft / \$ 408.60	50 ft / \$ 214.30
S-NY-APS-HD80-2.19-M056-35-X	2.19	56	-35	100 ft / \$ 467.60	50 ft / \$ 243.80
S-NY-APS-HD80-2.63-M067-42-X	2.63	67	-42	100 ft / \$ 612.60	50 ft / \$ 316.30
S-NY-APS-HD80-2.88-M073-46-X	2.88	73	-46	100 ft / \$ 685.80	50 ft / \$ 352.90
S-NY-APS-HD80-3.13-M080-50-X	3.13	80	-50	50 ft / \$ 367.40	25 ft / \$ 193.60
S-NY-APS-HD80-3.38-M086-54-X	3.38	86	-54	50 ft / \$ 399.20	25 ft / \$ 209.56
S-NY-APS-HD80-3.63-M092-58-X	3.63	92	-58	50 ft / \$ 426.20	25 ft / \$ 223.06
S-NY-APS-HD80-4.00-M102-64-X	4.00	102	-64	50 ft / \$ 471.80	25 ft / \$ 245.70

For the "X" value in the part number:  
specify "B" for Bulk Spool or "S" for Shop Spool

This sleeve is non-expandable – please measure your application carefully.

## Nylon 600 with PVC Coating Abrasion Protection Sleeve with Hook & Loop Closure - Light Duty

375°F / 190°C: Abrasion and Wear Resistance  
for Wire, Cable and Hose Protection

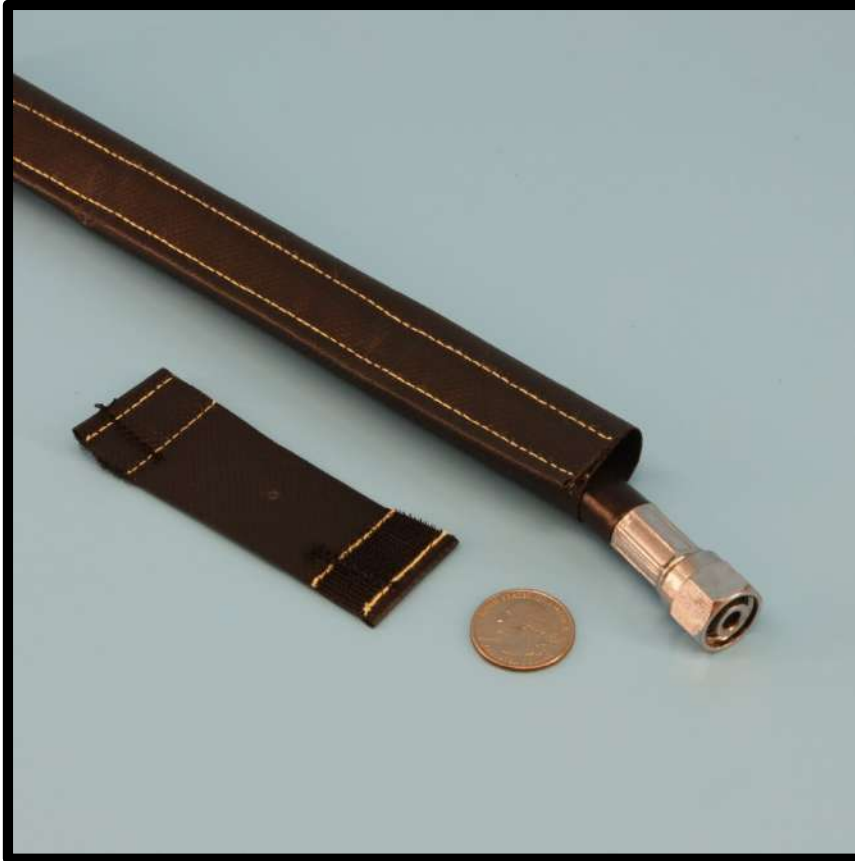

- Light duty abrasion and wear resistance for hoses, wire and cables.
- Sleeve with hook and loop for easy retrofit installation. Easy inspection.
- This sleeve is flexible PVC over a 600 denier nylon base fabric. Excellent protection for cables and hoses used on the ground, for construction equipment, drill rigs, etc.
- Temperature range - 13°F / -25°C to +158°F / 70°C.
- Very good UV protection
- Not recommended for welding applications. (Use sleeve with "WELD" in the part number)

Sold in 50 foot increments up to 150 feet continuous rolls. Available in standard sizes; larger or custom sizes can be easily fabricated if required. Helps to organize and bundle hoses and cables, excellent abrasion, scuff and wear resistance.

Other heavier duty materials available.

## Nylon with PVC Coating Abrasion Protection Sleeve with Hook & Loop Closure (Continued)

375°F / 190°C: Abrasion and Wear Resistance for Wire, Cable and Hose Protection

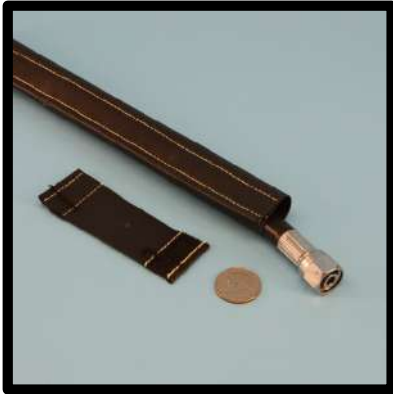

Scuff-Sleeve™ VCL: Nylon 600 with PVC Coating Abrasion Protection Sleeve with Hook and Loop Closure				
Part Number	Size			Price per Foot
	inch	mm	-dash	
*S-NY600-PVC-APS-VCL-M025-16	1.00	25	-16	\$ 6.40
*S-NY600-PVC-APS-VCL-M038-24	1.50	38	-24	\$ 7.70
S-NY600-PVC-APS-VCL-M044-28	1.75	44	-28	\$ 8.93
S-NY600-PVC-APS-VCL-M051-32	2.00	51	-32	\$ 9.13
S-NY600-PVC-APS-VCL-M060-38	2.38	60	-38	\$ 9.26
S-NY600-PVC-APS-VCL-M064-40	2.50	64	-40	\$ 9.43
S-NY600-PVC-APS-VCL-M070-44	2.75	70	-44	\$ 10.40
S-NY600-PVC-APS-VCL-M076-48	3.00	76	-48	\$ 10.46
S-NY600-PVC-APS-VCL-M083-52	3.25	83	-52	\$ 10.53
S-NY600-PVC-APS-VCL-M089-56	3.50	89	-56	\$ 10.56
S-NY600-PVC-APS-VCL-M102-64	4.00	102	-64	\$ 12.56
S-NY600-PVC-APS-VCL-M114-72	4.50	114	-72	\$ 12.63
S-NY600-PVC-APS-VCL-M127-80	5.00	127	-80	\$ 12.70
S-NY600-PVC-APS-VCL-M152-96	6.00	152	-96	\$ 15.56
S-NY600-PVC-APS-VCL-M178-112	7.00	165	-104	\$ 16.20
S-NY600-PVC-APS-VCL-M203-128	8.00	203	-128	\$ 17.43
S-NY600-PVC-APS-VCL-M241-152	9.50	241	-152	\$ 19.10
S-NY600-PVC-APS-VCL-M254-160	10.00	254	-160	\$ 20.70
S-NY600-PVC-APS-VCL-M279-176	11.00	279	-176	\$ 22.80
S-NY600-PVC-APS-VCL-M305-192	12.00	305	-192	\$ 26.93

Minimum Order Quantity may be in effect for smaller diameters

Width of the Velcro is 1.5" except part numbers indicated with (\*) which is .75".

Other sizes up to 16" ID are available



## Abrasion & Wear Protection Sleeve with Hook & Loop Closure for Wires, Cables and Hoses

### 1050 Denier Ballistic Nylon with Light PU Coating - Light Duty

-60°F / -51°C to 275°F / 135°C Temperature Range

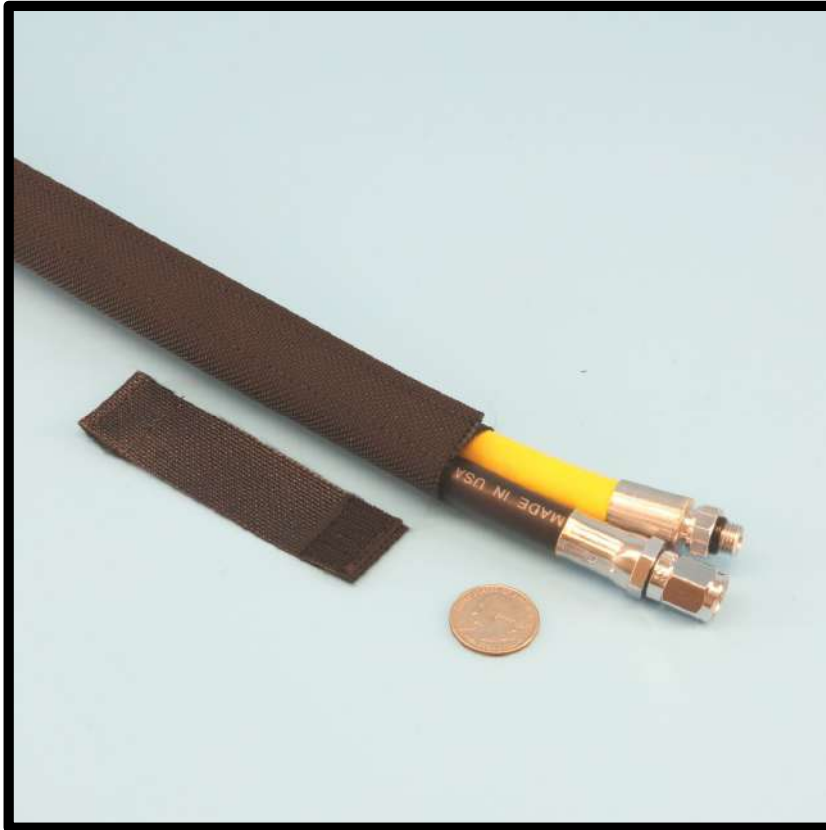

- Light duty abrasion and wear resistance for hoses, wire and cables.
- This sleeve has a hook and loop closure for easy retrofit installation.
- Used on mobile equipment and CE approved equipment for operator protection from hose failure.
- This sleeve is made from 1050 denier ballistic nylon which has a 1.7mil urethane coating for repelling surface moisture. 13.5oz/yd<sup>2</sup> material weight. Temperature range -60°C to +275°F. Very good UV protection.
- This is our most popular abrasion protection sleeve with a plain nylon fabric.
- Helps to organize and bundle hoses and cables; excellent abrasion, scuff and wear resistance
- Not recommended for welding applications. (Use sleeve with "WELD" in the part number).

One side of the material has a urethane coating, giving it a slightly shiny appearance. The sleeve should be installed with the coated side on the inside.

**Abrasion & Wear Protection Sleeve with Hook & Loop Closure for Wires, Cables and Hoses: 1050 Denier Ballistic Nylon with light PU Coating (Continued)**  
**-60°F / -51°C to 275°F / 135°C Temperature Range**



Scuff-Sleeve™ VCL: 1050 Ballistic Nylon Abrasion & Wear Protection Sleeve with Velcro Closure for wire, cable and hose						
Part Number	ID Size			Price		
	inch	mm	-dash	150 foot roll	50 foot roll	Per Foot
*S-NY1050-VCL-1.000-M025-16-X	1.00	25	-16	\$ 745.20	\$ 262.20	\$ 5.52
*S-NY1050-VCL-1.300-M033-21-X	1.30	33	-21	\$ 847.80	\$ 298.30	\$ 6.28
*S-NY1050-VCL-1.500-M038-24-X	1.50	38	-24	\$ 899.10	\$ 316.35	\$ 6.67
S-NY1050-VCL-1.750-M044-28-X	1.75	44	-28	\$ 1123.20	\$ 395.20	\$ 8.32
S-NY1050-VCL-2.000-M051-32-X	2.00	51	-32	\$ 1150.20	\$ 404.70	\$ 8.52
S-NY1050-VCL-2.380-M060-38-X	2.38	60	-38	\$ 1225.80	\$ 431.30	\$ 9.08
S-NY1050-VCL-2.500-M064-40-X	2.50	64	-40	\$ 1285.20	\$ 452.20	\$ 9.52
S-NY1050-VCL-2.750-M070-44-X	2.75	70	-44	\$ 1417.50	\$ 498.75	\$ 10.50
S-NY1050-VCL-3.000-M076-48-X	3.00	76	-48	\$ 1428.30	\$ 502.55	\$ 10.58
S-NY1050-VCL-3.250-M083-52-X	3.25	83	-52	\$ 1433.70	\$ 504.45	\$ 10.62
S-NY1050-VCL-3.500-M089-56-X	3.50	89	-56	\$ 1441.80	\$ 507.30	\$ 10.68
S-NY1050-VCL-4.000-M102-64-X	4.00	102	-64	\$ 1717.20	\$ 604.20	\$ 12.72
S-NY1050-VCL-4.500-M114-72-X	4.50	114	-72	\$ 1725.30	\$ 607.05	\$ 12.78
S-NY1050-VCL-5.000-M127-80-X	5.00	127	-80	\$ 1736.10	\$ 610.85	\$ 12.86
S-NY1050-VCL-6.000-M152-96-X	6.00	152	-96	\$ 2316.60	\$ 815.10	\$ 17.16
S-NY1050-VCL-7.000-M178-112-X	7.00	178	-112	\$ 2408.40	\$ 847.40	\$ 17.84
S-NY1050-VCL-8.000-M203-128-X	8.00	203	-128	\$ 2592.00	\$ 912.00	\$ 19.20
S-NY1050-VCL-9.000-M228-144-X	9.00	228	-144	\$ 2778.30	\$ 977.55	\$ 20.58
S-NY1050-VCL-10.000-M254-160-X	10.00	254	-160	\$ 3534.30	\$ 1243.55	\$ 26.18
S-NY1050-VCL-11.000-M279-176-X	11.00	279	-176	\$ 3688.20	\$ 1297.70	\$ 27.32
S-NY1050-VCL-12.000-M305-192-X	12.00	305	-192	\$ 3920.40	\$ 1379.40	\$ 29.04

For the "X" value in the part number:  
 "FOOT" for By-The-Foot, "150ROLL" for 150 foot roll "50ROLL" for 50 foot roll  
 Width of the Velcro is 1.5" except part numbers indicated with (\*) which is .75".  
 THIS PRODUCT IS AVAILABLE IN ANY ID SIZE – PLEASE ASK FOR A QUOTE

## Abrasion & Wear Protection Sleeve with Hook & Loop Closure for Wires, Cables and Hoses: 1000 Denier Nylon Medium Duty -60°F / -51°C to 275°F / 135°C Temperature Range

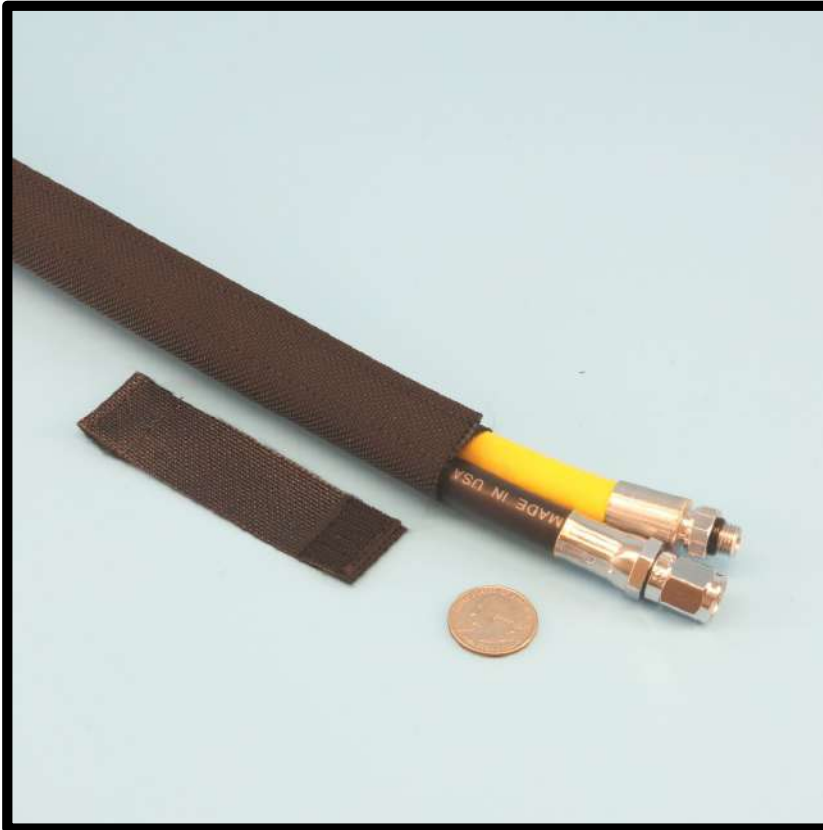

- Medium duty abrasion resistance for hoses, wire and cables.
- Sleeve with hook and loop for easy retrofit.
- Heavy urethane coating provides low coefficient of friction.
- Meets MIL-C-83489, FED-STD-191A, MIL-STD-810F
- This sleeve is made from 1000 denier nylon which has a 5mil urethane coating for repelling surface moisture. 13.5oz/yd<sup>2</sup> material weight. Temperature range -60°C to +275°F. Very good UV protection.
- Helps to organize and bundle hoses and cables; excellent abrasion, scuff and wear resistance
- Not recommended for welding applications. (Use sleeve with "WELD" in the part number).

**Abrasion & Wear Protection Sleeve with Hook & Loop Closure for Wires, Cables and Hoses: 1000 Denier Nylon with heavy PU coating  
-60°F / -51°C to 275°F / 135°C Temperature Range**

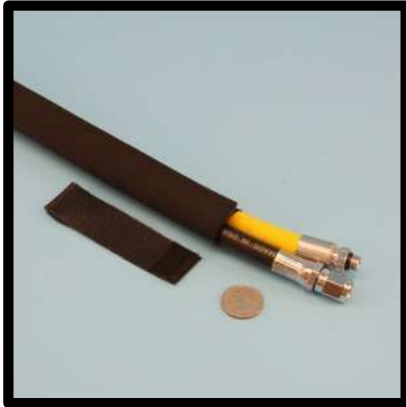

<b>Scuff-Sleeve™ VCL: 1000 Denier Nylon with PU Coating / Enhanced Abrasion &amp; Wear Protection Sleeve with hook &amp; loop Closure for wire, cable and hose</b>						
Part Number	ID Size			Price		
	inch	mm	-dash	150 foot roll	50 foot roll	Per Foot
*S-NY1000-VCL-1.000-M025-16-X	1.00	25	-16	\$ 918.00	\$ 323.00	\$ 6.80
*S-NY1000-VCL-1.300-M033-21-X	1.30	33	-21	\$ 1043.55	\$ 367.17	\$ 7.73
*S-NY1000-VCL-1.500-M038-24-X	1.50	38	-24	\$ 1107.00	\$ 389.50	\$ 8.20
S-NY1000-VCL-1.750-M044-28-X	1.75	44	-28	\$ 1386.45	\$ 487.83	\$ 10.27
S-NY1000-VCL-2.000-M051-32-X	2.00	51	-32	\$ 1421.55	\$ 500.18	\$ 10.53
S-NY1000-VCL-2.380-M060-38-X	2.38	60	-38	\$ 1507.95	\$ 530.58	\$ 11.17
S-NY1000-VCL-2.500-M064-40-X	2.50	64	-40	\$ 1583.55	\$ 557.18	\$ 11.73
S-NY1000-VCL-2.750-M070-44-X	2.75	70	-44	\$ 1750.95	\$ 616.08	\$ 12.97
S-NY1000-VCL-3.000-M076-48-X	3.00	76	-48	\$ 1764.45	\$ 620.83	\$ 13.07
S-NY1000-VCL-3.250-M083-52-X	3.25	83	-52	\$ 1768.50	\$ 622.25	\$ 13.10
S-NY1000-VCL-3.500-M089-56-X	3.50	89	-56	\$ 1777.95	\$ 625.58	\$ 13.17
S-NY1000-VCL-4.000-M102-64-X	4.00	102	-64	\$ 2115.45	\$ 744.33	\$ 15.67
S-NY1000-VCL-4.500-M114-72-X	4.50	114	-72	\$ 2123.55	\$ 747.18	\$ 15.73
S-NY1000-VCL-5.000-M127-80-X	5.00	127	-80	\$ 2137.05	\$ 751.93	\$ 15.83
S-NY1000-VCL-6.000-M152-96-X	6.00	152	-96	\$ 2857.95	\$ 1005.58	\$ 21.17
S-NY1000-VCL-7.000-M178-112-X	7.00	178	-112	\$ 2965.95	\$ 1043.58	\$ 21.97
S-NY1000-VCL-8.000-M203-128-X	8.00	203	-128	\$ 3190.05	\$ 1122.43	\$ 23.63

For the "X" value in the part number:

"FOOT" for By-The-Foot, "150ROLL" for 150 foot roll "50ROLL" for 50 foot roll

Width of the Velcro is 1.5" except part numbers indicated with (\*) which is .75".

THIS PRODUCT IS AVAILABLE IN ANY ID SIZE – PLEASE ASK FOR A QUOTE

**Heavy Duty Abrasion & Wear Protection Sleeve with Hook & Loop  
Closure for Wires, Cables and Hoses  
1500 Denier Nylon with HD Poly Coating  
-60°F / -51°C to 275°F / 135°C Temperature Range**

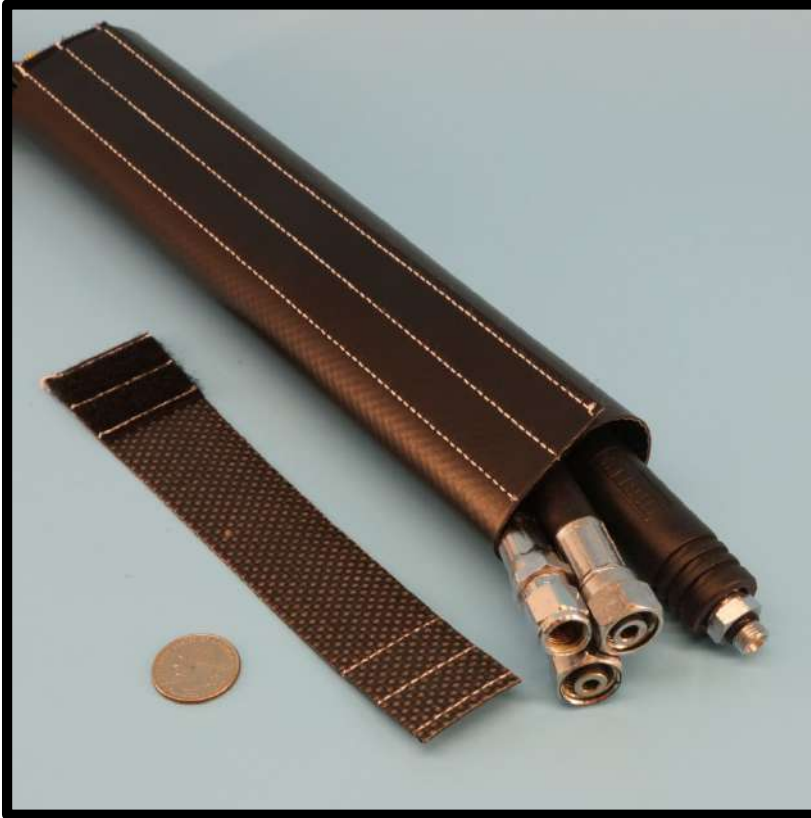

- Enhanced abrasion resistance for hoses, wire and cables.
- Sleeve with hook and loop for easy retrofit.
- Meets UV protection standard EN13758-1, Top Rating of 80
- MSHA - IC289 approved
- Meets ISO 6945 specifications - 500,000+ abrasion cycles.
  - The coating is thicker on one side, the base material is visible through the coating on the thin side and the thin side should be the inside when the sleeve is closed.
- Not recommended for welding applications. (for welding applications use sleeve with "WELD" in the part number).
  - This sleeve is made from 1500 denier nylon which has a polymer coating for advanced abrasion protection and the ability to repel surface moisture. 40oz/yd<sup>2</sup> material weight.
  - Temperature range - 60°C to +275°F.
  - Very good UV protection.
  - Helps to organize and bundle hoses and cables; excellent abrasion, scuff and wear resistance.



**Extreme Abrasion & Wear Protection Sleeve with Hook & Loop Closure for Wires, Cables and Hoses**  
**1500 Denier with HD Poly Coating**  
**-60°F / -51°C to 275°F / 135°C Temperature Range**



<b>Scuff-Sleeve™ VCL: XHD Nylon / Enhanced Abrasion &amp; Wear Protection Sleeve with Velcro Closure for wire, cable and hose</b>				
Part Number	ID Size inch / mm / -dash			Price
				75 foot roll
*S-NY1500-PVC-VCL-1.75-M044-28	1.75	44	-28	\$ 1582.50
S-NY1500-PVC-VCL-2.00-M051-32	2.00	51	-32	\$ 1591.88
S-NY1500-PVC-VCL-2.38-M060-38	2.38	60	-38	\$ 1612.50
S-NY1500-PVC-VCL-2.50-M064-40	2.50	64	-40	\$ 1758.75
S-NY1500-PVC-VCL-2.75-M070-44	2.75	70	-44	\$ 1805.63
S-NY1500-PVC-VCL-3.00-M076-48	3.00	76	-48	\$ 1873.13
S-NY1500-PVC-VCL-3.25-M083-52	3.25	83	-52	\$ 1938.75
S-NY1500-PVC-VCL-3.50-M089-56	3.50	89	-56	\$ 1995.00
S-NY1500-PVC-VCL-4.00-M102-64	4.00	102	-64	\$ 2326.88
S-NY1500-PVC-VCL-4.50-M114-72	4.50	114	-72	\$ 2336.25
S-NY1500-PVC-VCL-5.00-M127-80	5.00	127	-80	\$ 2358.75
S-NY1500-PVC-VCL-6.00-M152-96	6.00	152	-96	\$ 3150.00
S-NY1500-PVC-VCL-7.00-M178-112	7.00	178	-112	\$ 3189.38
S-NY1500-PVC-VCL-8.00-M203-128	8.00	203	-128	\$ 3236.25
S-NY1500-PVC-VCL-9.00-M228-144	9.00	228	-144	\$ 3369.38
S-NY1500-PVC-VCL-10.00-M241-152	10.00	254	-160	\$ 4089.38

Width of the Velcro is 1.5" except part numbers indicated with (\*) which is .75".

## Nylon with Neoprene Coating Welding & Abrasion Protection Sleeve with Hook & Loop Closure

375°F / 190°C: Abrasion and Welding Resistance for Wire, Cable and Hose Protection



- Welding with Abrasion resistance for hoses, wire and cables subject to dragging.
- Sleeve with hook and loop for easy retrofit.
- 1000 Denier Cordura with high flame retardant neoprene coating.
- Meets MIL-C-20696E, Type 2 Class 1.
- Construction Equipment, Drill Rigs, Mobile Welding.
- Excellent UV protection: Meets EN13758-1.
- Meets ISO 6945 for drag abrasion.
- Non wicking, Excellent puncture and tear resistant.
- The material has a dull luster, and either side may be used as the "inside" of the sleeve when closed.

Sold in 50 foot increments up to 150 feet continuous rolls. Available in standard sizes; larger or custom sizes can be easily fabricated if required. Helps to organize and bundle hoses and cables, excellent abrasion, scuff and wear resistance.

**Nylon with Neoprene Coating Welding & Abrasion Protection Sleeve with Hook & Loop Closure**  
**375°F / 190°C: Abrasion and Welding Resistance for Wire, Cable and Hose Protection**



<b>Scuff-Sleeve™ VCL: Nylon with Neoprene Coating Welding &amp; Abrasion Protection Sleeve with Hook and Loop Closure</b>				
<b>Part Number</b>	<b>Size</b>			<b>Price per Foot</b>
	<b>inch / mm / -dash</b>			
*S-NY-NP-APS-VCL-M025-16	1.00	25	-16	\$ 9.60
*S-NY-NP-APS-VCL-M038-24	1.50	38	-24	\$ 12.95
S-NY-NP-APS-VCL-M044-28	1.80	46	-29	\$ 14.35
S-NY-NP-APS-VCL-M051-32	2.00	51	-32	\$ 15.15
S-NY-NP-APS-VCL-M060-38	2.40	61	-38	\$ 16.40
S-NY-NP-APS-VCL-M064-40	2.50	64	-40	\$ 18.12
S-NY-NP-APS-VCL-M070-44	2.80	71	-44	\$ 18.63
S-NY-NP-APS-VCL-M076-48	3.00	76	-48	\$ 19.70
S-NY-NP-APS-VCL-M083-52	3.30	83	-52	\$ 19.83
S-NY-NP-APS-VCL-M089-56	3.50	89	-56	\$ 21.78
S-NY-NP-APS-VCL-M102-64	4.00	102	-64	\$ 24.67
S-NY-NP-APS-VCL-M114-72	4.50	114	-72	\$ 27.67
S-NY-NP-APS-VCL-M127-80	5.00	127	-80	\$ 28.30
S-NY-NP-APS-VCL-M152-96	6.00	152	-96	\$ 36.05
S-NY-NP-APS-VCL-M178-112	7.00	165	-104	\$ 36.43
S-NY-NP-APS-VCL-M203-128	8.00	203	-128	\$ 36.73
S-NY-NP-APS-VCL-M241-152	9.00	229	-144	\$ 62.17
S-NY-NP-APS-VCL-M305-192	9.50	241	-152	\$ 63.55

Minimum Order Quantity may be in effect for smaller diameters

Width of the hook/loop is 1.5" except part numbers indicated with (\*) which is .75".

## Fiberglass with Neoprene Coating Welding & Abrasion Protection Sleeve with Hook & Loop Closure

375°F / 190°C: Abrasion and Welding Protection for Wire, Cable and Hose



- Welding protection with abrasion resistance for hoses, wire and cables subject to dragging.
- Sleeve with hook and loop for easy retrofit.
- Fiberglass base material with high flame retardant neoprene coating.
- Construction Equipment, Drill Rigs, Mobile Welding.
- Excellent UV protection: Meets EN13758-1.
- Non wicking, Excellent puncture and tear resistant.
- Excellent chemical resistance.
- The material has a dull matt luster on both sides; either side can be the inside of the sleeve

Sold in 50 foot increments up to 150 feet continuous rolls. Available in standard sizes; larger or custom sizes can be easily fabricated if required. Helps to organize and bundle hoses and cables, excellent abrasion, scuff and wear resistance.

**Fiberglass with Neoprene Coating Welding & Abrasion Protection Sleeve with Hook & Loop Closure (Continued)**

**375°F / 190°C: Abrasion and Welding Protection for Wire, Cable and Hose**



<b>Scuff-Sleeve™ VCL: Nylon with Neopene Coating Welding &amp; Abrasion Protection Sleeve with Hook and Loop Closure</b>				
<b>Part Number</b>	<b>Size inch / mm / -dash</b>			<b>Price per Foot</b>
*S-FG-NP-APS-VCL-M025-16	1.00	25	-16	\$ 10.25
*S-FG-NP-APS-VCL-M038-24	1.50	38	-24	\$ 13.83
S-FG-NP-APS-VCL-M044-28	1.80	46	-29	\$ 15.33
S-FG-NP-APS-VCL-M051-32	2.00	51	-32	\$ 16.18
S-FG-NP-APS-VCL-M060-38	2.40	61	-38	\$ 17.53
S-FG-NP-APS-VCL-M064-40	2.50	64	-40	\$ 19.35
S-FG-NP-APS-VCL-M070-44	2.80	71	-44	\$ 19.90
S-FG-NP-APS-VCL-M076-48	3.00	76	-48	\$ 21.05
S-FG-NP-APS-VCL-M083-52	3.30	83	-52	\$ 21.18
S-FG-NP-APS-VCL-M089-56	3.50	89	-56	\$ 23.25
S-FG-NP-APS-VCL-M102-64	4.00	102	-64	\$ 26.38
S-FG-NP-APS-VCL-M114-72	4.50	114	-72	\$ 29.57
S-FG-NP-APS-VCL-M127-80	5.00	127	-80	\$ 30.22
S-FG-NP-APS-VCL-M152-96	6.00	152	-96	\$ 38.50
S-FG-NP-APS-VCL-M178-112	7.00	165	-104	\$ 38.90
S-FG-NP-APS-VCL-M203-128	8.00	203	-128	\$ 39.20
S-FG-NP-APS-VCL-M241-152	9.00	229	-144	\$ 41.73
S-FG-NP-APS-VCL-M305-192	9.50	241	-152	\$ 43.10

Minimum Order Quantity may be in effect for smaller diameters

Width of the hook/loop is 1.5" except part numbers indicated with (\*) which is .75".





**Abrasion Protection & General Organizing Sleeve – custom sized**  
**375°F / 190°C: Scuff-Sleeve™ VC, with Velcro: for Wire, Cable and Hose**  
**Custom Sized**



- Abrasion resistance for hoses, wire and cables.
- Sleeve with hook & loop for easy retrofit.
- HD Nylon.

HD Nylon sleeve is made from 1050 denier nylon (heavy duty “ballistic” nylon) which has a 1.5oz urethane coating. Temperature range -60°C to +375°F. Very Good UV protection.

This sleeve is fabricated from slit fabric that has hook & loop closure added along each long side, resulting in a sleeve that is custom fit for your application.

Minimum order is \$50 per size. Maximum length is 150 feet.

The ID of this sleeve is a minimum of 1 inch and the maximum is almost limitless.

Helps to organize and bundle hoses and cables, excellent abrasion, scuff and wear resistance.

<b>Scuff-Sleeve™ Custom VCL: Abrasion Protection Sleeve with Hook &amp; Loop</b>	
<b>Part Number</b>	<b>Price per Foot</b>
S-NY-APSC-VCL-MXXX-Y-Z	\$ 4.31 per inch of ID x sleeve length in feet + \$ 3.61 x sleeve length in feet

For the “X” value in the part number: specify the inside diameter in millimetres.

For the “Y” value in the part number: specify the inside diameter in 1/16 of an inch increments.

For the “Z” value in the part number: specify the length of the sleeve in feet.

Pricing Example: For a 5.5” ID sleeve that is 12 feet long.

$$(\$ 4.31 \times 5.5 \times 12) + (3.61 \times 12) = \$ 284.46 + \$ 43.32$$

Total sleeve cost is \$ 327.78

## Hydraulic Blowout Protection Sleeve - SuperGuard™

375°F / 190°C Maximum Continuous  
Protects Personnel from Hydraulic Hose & Line Blowout

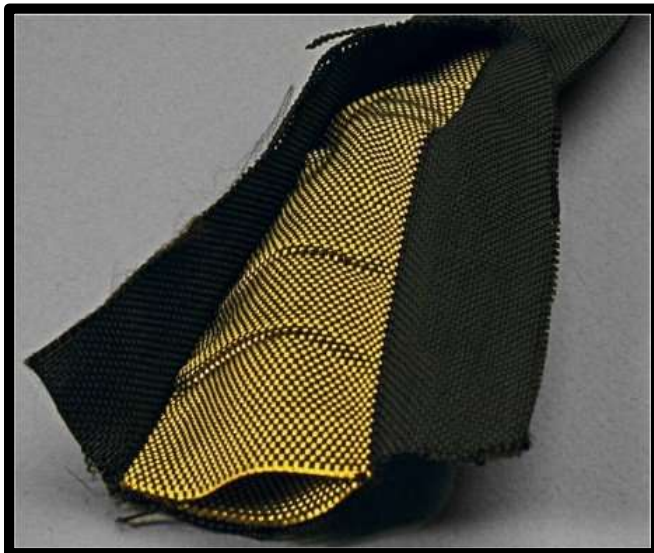

- SuperGuard™ Dual layer Nylon – Nylon/Polyester construction provides protection from blowout to 13,000 PSI.
- Abrasion, wear, puncture and cut resistant protection sleeve for hydraulic hoses and lines.
- Exceeds the new “Line of Sight” operator protection regulations EN982 ISO norm 833 EN414 for hose blowout.
- Ultra dense construction is 3 times the density of our most heavy duty abrasion protection sleeve.
- Tight weave and smooth surface resists abrasive wear.
- Excellent UV resistance.
- MSHA IC 171/2 approved.
- Exceeds ISO 6945 abrasion standard and ISO 8031 conductivity standard.
- Easily cut to length or cut with heat knife.
- Useable -60°F to +375°F.
- If the inner yellow layer shows, then the sleeve must be replaced due to wear.
- NOTE: This sleeve should NOT fit tightly on the hose it is protecting, but have a clearance of ½” to 1”.
- Tested by the Fluid Power Institute.
- Also meets ISO 3457, ISO 4413, MDG41

SuperGuard™ Hydraulic Blowout Protection Sleeve				
Part Number	Nominal ID Size			Price per Coil
	inch	mm	-dash	
S-NY-BPS-M026-17	1.21	30	-19	\$ 229.00
S-NY-BPS-M030-20	1.34	34	-21	\$ 236.00
S-NY-BPS-M036-23	1.41	36	-23	\$ 242.00
S-NY-BPS-M039-26	1.62	41	-26	\$ 260.00
S-NY-BPS-M043-28	1.81	46	-29	\$ 277.00
S-NY-BPS-M047-30	2.10	53	-31	\$ 320.00

- Available By-The-Foot or in 100 foot coils.
- This sleeve is non-expandable – please measure your application carefully.

## SPF Spray Foam Hose Protector Sleeve with Hook & Loop Closure

Ballistic Nylon Abrasion & Wear Protection Sleeve with Hook & Loop Closure - Plain or with ThermGuard® Freeze Protection Liner



- Abrasion resistance and wear protection for SPF Spray Foam Hoses. FAST installation
- Sleeve with hook and loop for easy retrofit.
- Plain or with thermal liner for winter freeze protection.

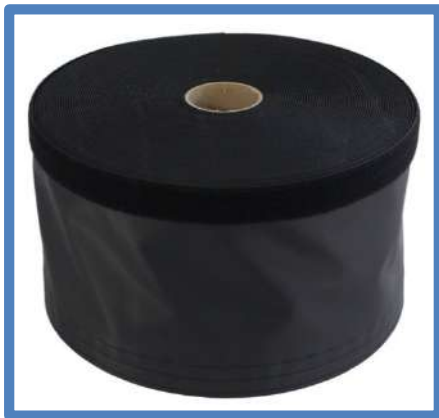

### SPF Spray Foam Hose Wrap

Part Number: S-NY-SPF-SW-2173 Ballistic Nylon with heavy urethane coating.  
50 foot length - 7.4 inch circumference to easily cover hoses.  
\$291.60

Part Number: S-NY-SPF-SW-2175 Ballistic Nylon with heavy urethane coating and ThermGuard insulation layer  
50 foot length - 8.6" circumference. Nominal thermal retention of 25°F over non insulated sleeve.  
\$490.63

Part Number: S-NY-SPF-SW-2174 Coupler Guard  
\$33.48

Part Number: S-NY-SPF-SW-2176 Coupler Guard with ThermGuard insulation layer  
\$60.00

**HVAC refrigerant line insulation protection sleeve - HVACGuard™**  
**375°F / 190°C Maximum Continuous**  
**Building Code Complaint: C 403.2.10.1 & R 403.4.1**



- HVACGuard™ is a coated polyester woven sleeve with a hook and loop closure system allowing for easy installation and removal.
- Used to wrap refrigerant lines which have an insulation layer.
- 1 1/2" wide hook and loop allows for adjustable snug fit and use on a variety of pipe/insulation sizes and tight bends.
- Abrasion, wear, weather, UV, puncture and cut resistant protection.
- Easily cut to length or cut with heat knife.
- Useable -60°F to +375°F.

<b>HVACGuard™ Refrigerant Insulation Protection</b>				
<b>Building Code Complaint C 403.2.10.1 &amp; R 403.4.1</b>				
<b>Part Number</b>	<b>Nominal ID Size inch / mm / -dash</b>			<b>Price per Spool Bulk Spool / Shop Spool</b>
S-POLY-APS-HVAC-M038-24	1.50	38	-24	\$ call / \$ call
S-POLY-APS-HVAC-M051-32	2.00	51	-32	\$ call / \$ call
S-POLY-APS-HVAC-M064-40	2.50	64	-40	\$ call / \$ call
S-POLY-APS-HVAC-M076-48	3.00	76	-48	\$ call / \$ call
S-POLY-APS-HVAC-M089-56	3.50	89	-56	\$ call / \$ call
S-POLY-APS-HVAC-M102-64	4.00	102	-64	\$ call / \$ call
S-POLY-APS-HVAC-M114-72	4.50	114	-72	\$ call / \$ call

- Available in 150 foot bulk spool and 25 foot shop spool.

## PET Flexible Wrappable Split Braid Sleeve

257°F / 125°C: Maximum Continuous – Melts at 482°F / 250°C



- .024" and .038" Wall Thickness .
- Good organization for in-place wires and cables.
- Medium duty abrasion resistance.
- Available in four colors: Black, Orange, Gray, Clear-White.
- Easily cut to length or cut with heat knife.
- Provides a 25% edge overlap at nominal diameter.

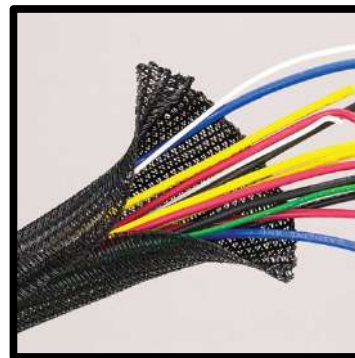

Scuff-Sleeve™ PET Flexible Wrappable Split Braid Sleeve Medium Protection Sleeve						
Part Number	ID Size inch / mm / -dash			Spool Size & Price		
				Bulk Spool	Shop Spool A	Shop Spool B
S-PETSPLIT-APS-0.125-M003-02-X	0.125	3	-02	8000 ft / \$ 1732.00	400 ft / \$ 90.00	100 ft / \$ 33.00
S-PETSPLIT-APS-0.250-M006-04-X	0.250	6	-04	3000 ft / \$ 1214.80	200 ft / \$ 84.90	100 ft / \$ 52.00
S-PETSPLIT-APS-0.375-M009-06-X	0.375	9.5	-06	1500 ft / \$ 872.80	150 ft / \$ 90.40	75 ft / \$ 56.60
S-PETSPLIT-APS-0.500-M013-08-X	0.500	12.7	-08	1200 ft / \$ 746.40	150 ft / \$ 98.70	75 ft / \$ 60.60
S-PETSPLIT-APS-0.750-M019-12-X	0.750	19.0	-12	500 ft / \$ 396.40	100 ft / \$ 82.20	50 ft / \$ 52.00
Above sleeve .024" wall thickness – below sleeve .038" wall thickness						
S-PETSPLIT-APS-1.000-M025-16-X	1.000	25.4	-16	400 ft / \$ 440.20	100 ft / \$ 116.60	50 ft / \$ 68.00
S-PETSPLIT-APS-1.250-M032-20-X	1.250	31.7	-20	250 ft / \$ 450.20	75 ft / \$ 140.60	25 ft / \$ 56.00
S-PETSPLIT-APS-1.500-M038-24-X	1.500	38.1	-24	250 ft / \$ 540.20	75 ft / \$ 170.60	25 ft / \$ 68.00
S-PETSPLIT-APS-2.000-M051-32-X	2.000	50.8	-32	200 ft / \$ 597.00	50 ft / \$ 160.00	25 ft / \$ 89.00

For the "X" value in the part number:  
specify "B" for Bulk Spool or "SA" for Large Shop Spool or "SB" for Small Shop Spool

Specify Color when ordering – Add 20% for colors other than black  
(except 1/8 size is 10000 foot box add 30%)

Helps to organize and bundle hoses and cables, while proving abrasion, scuff and wear resistance.



**Polyester Flexible Wrappable Split Woven Sleeve**  
257°F / 125°C: Maximum Continuous – Melts at 482°F / 250°C



- .027” Wall Thickness .
- Good organization for in-place wires and cables.
- High abrasion resistance.
- Available in Black & White.
- Easily cut to length or cut with heat knife.



Scuff-Sleeve™ POLYWRAP Flexible Wrappable Split Woven Sleeve High Abrasion Protection Sleeve						
Part Number	ID Size inch / mm / -dash			Spool Size & Price		
				Bulk Spool	Shop Spool A	Shop Spool B
S-POLYSPLIT-APS-0.125-M003-02-X	0.125	3	-02	1800 ft / \$ 954.00	900 ft / \$ 476.00	300 ft / \$ 172.00
S-POLYSPLIT-APS-0.187-M005-03-X	0.187	4.7	-03	1200 ft / \$ 660.00	600 ft / \$ 330.00	200 ft / \$ 126.00
S-POLYSPLIT-APS-0.250-M006-04-X	0.250	6	-04	925 ft / \$ 530.80	460 ft / \$ 264.90	200 ft / \$ 129.00
S-POLYSPLIT-APS-0.312-M008-05-X	0.312	7.9	-05	650 ft / \$ 370.80	325 ft / \$ 185.40	125 ft / \$ 84.60
S-POLYSPLIT-APS-0.375-M009-06-X	0.375	9.5	-06	450 ft / \$ 284.80	225 ft / \$ 144.40	100 ft / \$ 81.60
S-POLYSPLIT-APS-0.500-M013-08-X	0.500	12.7	-08	300 ft / \$ 201.40	150 ft / \$ 102.70	75 ft / \$ 64.60
S-POLYSPLIT-APS-0.625-M016-10-X	0.625	15.8	-10	250 ft / \$ 193.40	125 ft / \$ 99.20	75 ft / \$ 69.00
S-POLYSPLIT-APS-0.750-M019-12-X	0.750	19.0	-12	150 ft / \$ 128.40	100 ft / \$ 86.20	50 ft / \$ 55.00
S-POLYSPLIT-APS-1.000-M025-16-X	1.000	25.4	-16	100 ft / \$ 107.20	75 ft / \$ 82.60	50 ft / \$ 64.00
S-POLYSPLIT-APS-1.500-M038-24-X	1.500	38.1	-24	50 ft / \$ 100.20	25 ft / \$ 51.60	N/A
S-POLYSPLIT-APS-1.750-M044-28-X	1.750	44.4	-28	50 ft / \$ 146.20	10 ft / \$ 42.60	N/A
S-POLYSPLIT-APS-2.000-M051-32-X	2.000	50.8	-32	40 ft / \$ 142.00	10 ft / \$ 48.00	N/A

For the “X” value in the part number:  
specify “B” for Bulk Spool or “SA” for Large Shop Spool or “SB” for Small Shop Spool

Specify Color when ordering – Add 20% for white

Helps to organize and bundle hoses and cables, while proving abrasion, scuff and wear resistance.

**Polyester Flexible Wrappable Split Woven Sleeve with Hook One Side**  
257°F / 125°C: Maximum Continuous – Melts at 482°F / 250°C

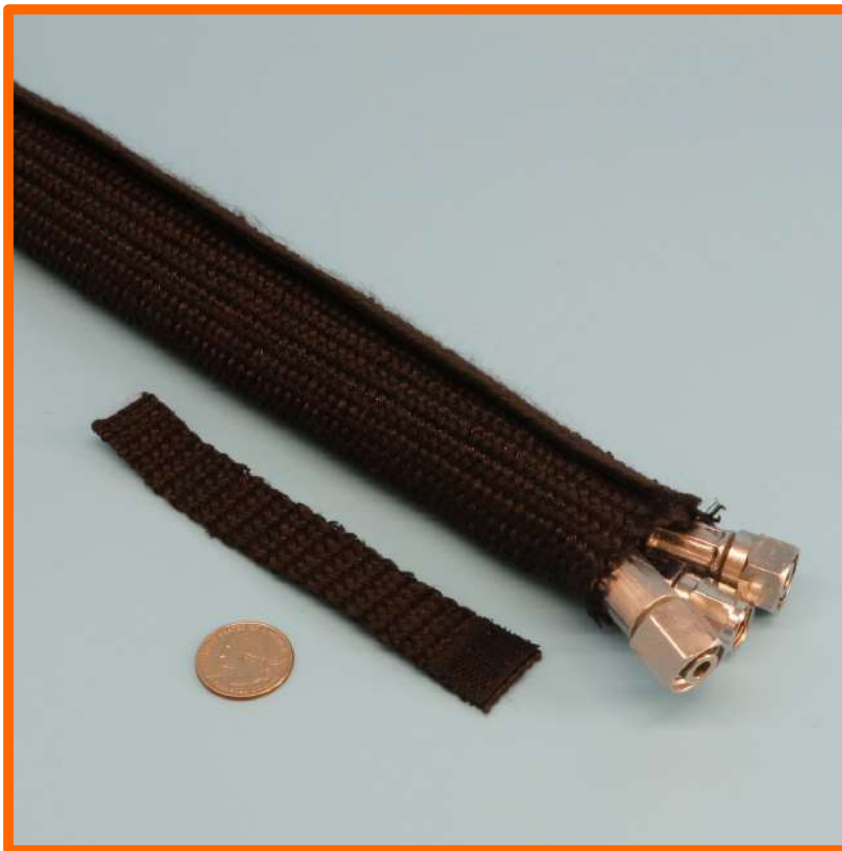

- .025" Wall Thickness .
- Good organization for in-place wires and cables. One side hook helps keep sleeve closed without extra wrapping with clamps or tape.
- High abrasion resistance.
- Available in Black only.
- Easily cut to length or cut with heat knife.
- Soft and pliable to work with.

<b>Scuff-Sleeve™ POLYWRAP Hook Flexible Wrappable Split Woven Sleeve High Abrasion Protection Sleeve – with Hook One Side – Extra Hold</b>					
Part Number	ID Size inch / mm / -dash			Spool Size & Price	
				Bulk Spool	Shop Spool
S-POLYSPLITHCL-APS-0.750-M019-12-X	0.750	19.0	-12	50 ft / \$ 82.40	25 ft / \$ 53.20
S-POLYSPLITHCL-APS-1.000-M025-16-X	1.000	25.4	-16	50 ft / \$ 97.20	25 ft / \$ 64.60
S-POLYSPLITHCL-APS-1.375-M035-26-X	1.375	34.9	-26	50 ft / \$ 109.20	25 ft / \$ 69.60

For the "X" value in the part number:  
specify "B" for Bulk Spool or "S" for Shop Spool

Helps to organize and bundle hoses and cables, while proving abrasion, scuff and wear resistance.

## Braided PET 150% Expandable Sleeve

257°F / 125°C: Maximum Continuous – Melts at 482°F / 250°C



- .010" monofilament thickness.
- Organization with abrasion resistance.
- Available in 27 colors / patterns
- Easily cut to length or cut with heat knife.
- Expandable by 150% to pass over connectors.
- FMVSS 302 & FAR 25 approved



Scuff-Sleeve™ PET Flexible 150% Expandable Braid Sleeve						
Part Number	Range	Nominal ID Size fraction / inch / mm			Spool Size & Price	
					Bulk Spool	Shop Spool
S-PET-BRAID-EXP-0.062-M0016-XX-YY	3/64 – 3/32	1/16	0.062	1.6	1000 ft / \$ 110.00	250 ft / \$ 46.00
S-PET-BRAID-EXP-0.125-M0032-XX-YY	3/32 – 1/4	1/8	0.125	3.2	1000 ft / \$ 120.00	225 ft / \$ 46.00
S-PET-BRAID-EXP-0.250-M0063-XX-YY	1/8 – 7/16	1/4	0.250	6.3	1000 ft / \$ 127.50	200 ft / \$ 46.00
S-PET-BRAID-EXP-0.375-M0095-XX-YY	3/16 – 1/2	3/8	0.375	9.5	500 ft / \$ 110.00	125 ft / \$ 46.00
S-PET-BRAID-EXP-0.500-M0127-XX-YY	¼ - 3/4	1/2	0.500	12.7	500 ft / \$ 150.00	100 ft / \$ 46.00
S-PET-BRAID-EXP-0.625-M0158-XX-YY	3/8 - 1	5/8	0.625	15.8	500 ft / \$ 190.00	100 ft / \$ 46.00
S-PET-BRAID-EXP-0.750-M0190-XX-YY	½ - 1 1/4	3/4	0.750	19.0	250 ft / \$ 110.00	75 ft / \$ 46.00
S-PET-BRAID-EXP-1.000-M0254-XX-YY	5/8 – 1 5/8	1	1.000	25.4	250 ft / \$ 125.00	65 ft / \$ 46.00
S-PET-BRAID-EXP-1.250-M0317-XX-YY	¾ - 1 3/4	1-1/4	1.250	31.7	250 ft / \$ 150.00	50 ft / \$ 46.00
S-PET-BRAID-EXP-1.500-M0381-XX-YY	1 – 2 1/8	1-1/2	1.500	38.1	200 ft / \$ 152.00	40 ft / \$ 46.00
S-PET-BRAID-EXP-1.750-M0445-XX-YY	1 ¼ - 2 3/4	1-3/4	1.750	44.5	200 ft / \$ 200.00	30 ft / \$ 46.00
S-PET-BRAID-EXP-2.000-M0508-XX-YY	1 ½ - 3 1/2	2	2.000	50.8	200 ft / \$ 280.00	50 ft / \$ 80.00
S-PET-BRAID-EXP-2.500-M0635-XX-YY	1 ¾ - 3 5/8	2-1/2	2.500	63.5	200 ft / \$ 360.00	50 ft / \$ 100.00
S-PET-BRAID-EXP-3.000-M0762-XX-YY	2 ½ - 4 3/4	3	3.000	76.2	100 ft / \$ 200.00	50 ft / \$ 110.00

Specify Color/Pattern when ordering – Add 15% for colors other than black  
( 1/16 size is only available in Black )

For the “XX” value in the part number: specify **WH** - White; **NP** – Neon Pink; **NR** – Neon Red; **NY** – Neon Yellow; **NG** – Neon Green; **NB** – Neon Blue; **PP** – Purple; **BE** – Beige; **GY** – Gray; **OG** – Orange; **JS** – Jester; **NX** – Nitrox; **CL** – Clear; **RD** – Red; **OR** – Orange; **YL** – Yellow; **GN** – Green; **BL** – Blue; **DP** – Dark Purple; **BR** – Brown; **CB** – Carbon; **SH** – Super Hero; **SS** - Safety Stripe; **PT** – Patriot; **PG** – Platinum Gray; **CF** – Checkered Flag

For the “YY” value in the part number: specify “BS” for Bulk Spool or “SS” for Shop Spool

Helps to organize and bundle hoses and cables, while proving abrasion, scuff and wear resistance.

## Cinch and Hanging Straps for wire cable and hose organization



- Ultrasonic welded seams.
- All seams tested.
- Designed for bundling and hanging of wires, cables, hoses and tubing.
- Has a small amount of expansion margin. Allows for hose expansion. Safer than cable ties for the hose or cable outer layer.
- No tools required to install.
- Straps may be combined to lengthen.
- Excellent UV resistance.
- Standard duty model uses Delrin buckle.
- Heavy Duty uses a nickel plated steel buckle.

Scuff-Sleeve™ Cinch and Hanging Straps - Standard and Heavy Duty					
Part Number	Size in Length inch / mm		Adjustable Diameter	Price, each Standard	Price, each Heavy Duty
<b>Cinch Straps</b>					
CO-CS-04-X	4	102	1.1 - 1.3	\$ 2.67	\$ 7.75
CO-CS-06-X	6	152	1.7 - 1.9	\$ 3.08	\$ 9.30
CO-CS-08-X	8	203	2.1 - 2.5	\$ 3.45	\$ 10.83
CO-CS-10-X	10	254	2.5 - 3.2	\$ 4.05	\$ 12.33
CO-CS-12-X	12	305	2.8 - 3.8	\$ 4.20	\$ 13.75
CO-CS-16-X	16	406	3.4 - 5.1	\$ 4.93	\$ 15.10
CO-CS-20-X	20	508	4.1 - 6.4	\$ 5.70	\$ 17.00
CO-CS-24-X	24	609	4.7 - 7.6	\$ 6.03	\$ 18.85
CO-CS-30-X	30	762	5.6 - 9.5	N/A	\$ 21.73
CO-CS-36-X	36	914	7.5 - 11.4	N/A	\$ 25.45
CO-CS-40-X	40	1016	9.5 - 12.7	N/A	\$ 28.23
<b>Hanging Straps</b>					
CO-HS-04-X	4	102	1.1 - 1.3	\$ 5.85	\$ 15.05
CO-HS-06-X	6	152	1.7 - 1.9	\$ 6.15	\$ 15.73
CO-HS-08-X	8	203	2.1 - 2.5	\$ 6.50	\$ 17.08
CO-HS-12-X	12	305	2.8 - 3.8	\$ 7.28	\$ 18.25
CO-HS-16-X	16	406	3.4 - 5.1	\$ 8.00	\$ 20.28
CO-HS-20-X	20	508	4.1 - 6.4	\$ 8.48	\$ 22.18
CO-HS-26-X	26	660	4.7 - 8.2	N/A	\$ 25.00
CO-HS-30-X	32	812	5.6 - 10.1	N/A	\$ 28.97
CO-HS-36-X	36	914	7.5 - 11.4	N/A	\$ 32.87

For the "X" value in the part number: specify "SD" for Standard Duty or "HD" for Heavy Duty

Standard Duty straps are packaged in quantities 10. Heavy Duty straps are packaged in quantities of 5

## CarpetCover™ Cable /Wiring Organizer

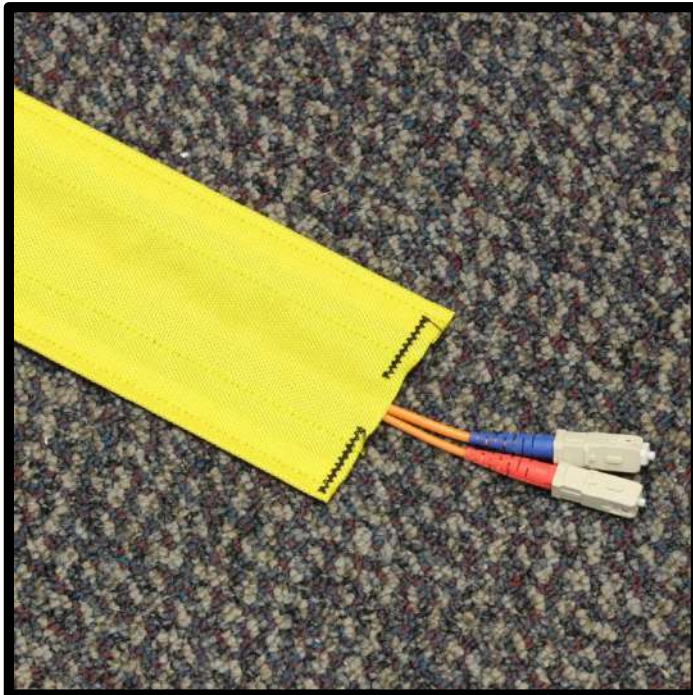

- Nylon with hook closure on each edge.
- Works well with all carpeting containing loops of yarn.
- Reuseable
- Minimizes trip hazards. High visibility yellow color available for dark carpeting.
- No tools required to install.
- No sticky residue when removed.
- Excellent UV resistance.
- 3, 4 & 5 inch widths available.
- .012" fabric thickness

CarpetCover™ Cable / Wiring Organizer			
Part Number	Width	Price, each 25 foot roll	Price, each 150 foot roll
T-NY-CC-48-X	3"	\$ 92.55	\$ 3.27 / ft
T-NY-CC-64-X	4"	\$ 104.21	\$ 3.86 / ft
T-NY-CC-80-X	5"	\$ 112.53	\$ 4.11 / ft

Color: For the "X" value in the part number:  
 specify "GY" for Grey, "BR" for Brown, "BL" for Blue, "GR" for Green, "YL" for Yellow, "BK" for Black



## Hard Shell Acetate Spiral Wrap - Hose and Cable Protection –

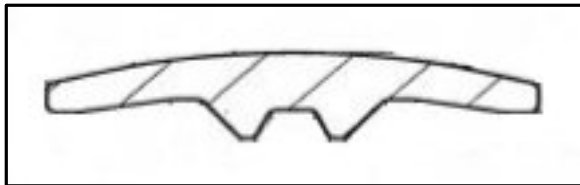

- Tuff-Wrap™ abrasion protection wrap is manufactured from highly impact resistant plasticised cellulose acetate, and is simply wrapped over hose or cable to provide a tough protection shell to reduce abrasion damage.
- This shell is much tougher than our HDPE or fabric abrasion protection sleeve and is ideal for harsh environments such as outdoor construction or where hoses and cables might be dragged repetitively over concrete plant floors. Rounded edges prevents hose and cable cover damage from flexing of spiral.
- Available in sizes to wrap individual or bundled hoses and cables with a total ID up to 6 inches or 152mm.
- Stays in place without sliding due to the 2 ribs at the rear that ride on the cover layer of the hose or cable.
- Springs back when twisted and pulled.
- Rockwell hardness between 75-120.
- UV and ozone resistant.

The unique profile shape of this product makes it a far superior spiral wrap to any flat profile wrap made of PE, PU or Nylon. Smooth rounded edges with a center double ridge on the inside of the profile and a curved shell allows the spiral to grip onto cables or hoses without damage but with flexibility.

Tuff-Wrap™ spiral wrap provides abrasion, scuff and wear resistance and helps to organize and bundle hoses and cables. Temperature range -30 to + 185°F continuous duty. This product is not self extinguishing.

<b>Tuff-Wrap™ Heavy Duty Acetate                      Hard Shell Spiral Wrap for Abrasion Protection</b> 40 foot standard lengths for sizes up to 1.75" ID / 25 foot lengths from 2.56" ID to 4" ID 15 foot standard length for 6" ID					
Part Number	ID Size inch / mm / -dash			Pitch in inches	Price per Length Black / Yellow
SW-AP-PCA-M006-04-X	0.25	6	-04	0.25	\$ 49.20 / \$ 91.66
SW-AP-PCA-M008-05-X	0.325	8	-05	0.25	\$ 53.37 / \$ 93.33
SW-AP-PCA-M010-06-X	0.37	10	-06	0.25	\$ 57.75 / \$ 95.72
SW-AP-PCA-M013-08-X	0.50	13	-08	0.50	\$ 61.50 / \$ 98.89
SW-AP-PCA-M016-10-X	0.62	16	-10	0.50	\$ 66.50 / \$ 109.93
SW-AP-PCA-M019-12-X	0.75	19	-12	0.62	\$ 79.75 / \$ 126.84
SW-AP-PCA-M025-16-X	1.00	25	-16	0.62	\$ 119.00 / \$ 177.33
SW-AP-PCA-M028-18-X	1.10	29	-18	0.62	\$ 189.20 / \$ 301.33
SW-AP-PCA-M035-22-X	1.38	35	-22	0.67	\$ 245.00 / \$ 385.66
SW-AP-PCA-M044-28-X	1.75	44	-28	0.80	\$ 275.80 / \$ 415.33
SW-AP-PCA-M048-30-X	1.88	48	-30	0.80	\$ 275.80 / \$ 415.33
SW-AP-PCA-M067-42-X *	2.56	67	-42	1.37	\$ 307.75 / \$ 443.13
SW-AP-PCA-M080-50-X *	3.15	80	-50	1.37	\$ 356.00 / \$ 552.47
SW-AP-PCA-M090-57-X *	3.54	90	-57	1.37	\$ 381.57 / \$ 572.27
SW-AP-PCA-M102-64-X *	4.00	102	-64	2.00	\$ 415.50 / \$ 613.17
SW-AP-PCA-M152-96-X **	6.00	152	-96	2.00	\$ 496.00 / \$ 733.44

For the "X" value in the part number: Use "BK" for Black, "YL" for Yellow

**Chemical Resistance:** Water – very good; Ionic metallic solution – very good; gasoline – very good; oil – very good; mineral & vegetable oil – very good; Superior alcohols – very good; Acetone – poor; Methyl acetate – poor; Ethyl acetate – poor; Chlorine solvent – poor; Strong Acids and Strong Bases – may have some corrosive action; Inferior alcohols – after prolonged immersion may expand product but do not act as solvent.

## HDPE Spiral Wrap Hard Shell Hose and Cable Protection SafeEdge™



- SafeEdge™ abrasion protection spiral wrap is manufactured from highly impact resistant high density polyethylene, and is simply wrapped over hose or cable to provide a tough protection shell to reduce abrasion damage.
- Rounded edges prevents hose and cable damage from flexing of spiral. Superior to cheaper spiral made from slit plastic pipe resulting in sharp edges.
- Available in sizes to wrap individual or bundled hoses and cables with a total ID up to 5 inches or 127mm.
- Stays in place without sliding. Springs back when twisted and pulled.
- Yellow and Black are available as standard colors. Other colors may be available from stock or by lot run.
- Temperature range -60 to + 175°F. Resistant to acids, oils and solvents.

SafeEdge™ High Density Polyethylene Hard Shell Spiral Wrap for Cable & Hose Abrasion Protection						
Part Number	ID Size			Pitch in inches	Wall Thickness in inches	Coil Length Feet / Price per Coil
	inch	mm	-dash			
SW-HDP-0.40-M010-07-XX	0.40	10	-07	0.4	.05	100 / \$ 193.00
SW-HDP-0.50-M013-08-XX	0.50	13	-08	0.47	.05	100 / \$ 203.33
SW-HDP-0.65-M016-10-XX	0.65	16	-10	0.8	.05	100 / \$ 220.00
SW-HDP-0.80-M021-14-XX	0.80	21	-14	1.0	.10	100 / \$ 236.81
SW-HDP-1.10-M027-17-XX	1.10	27	-17	0.9	.10	100 / \$ 267.46
SW-HDP-1.40-M035-22-XX	1.40	35	-22	.94	.11	100 / \$ 396.84
SW-HDP-1.70-M043-27-XX	1.70	43	-27	1.2	.13	100 / \$ 536.67
SW-HDP-2.20-M056-35-XX	2.20	56	-35	1.5	.15	100 / \$ 736.71
SW-HDP-2.60-M066-42-XX	2.60	66	-42	1.75	.17	75 / \$ 732.50
SW-HDP-3.20-M081-51-XX	3.20	81	-51	1.75	.19	50 / \$ 646.64
SW-HDP-3.90-M099-62-XX	3.90	99	-62	2.00	.22	50 / \$ 861.37
SW-HDP-4.50-M114-72-XX	4.50	114	-72	2.04	.23	40 / \$ 874.91
SW-HDP-5.00-M127-80-XX	5.00	127	-80	2.16	.25	30 / \$ 749.00

For the "XX" value in the part number: Use "BK" for Black, "YL" for Yellow

Special colors available:

OR for Orange, RD for Red, GR for Green, BL for Blue, GY for Grey, PR for Purple

Add 15% for special colors.

Special colors may be available from stock. If not, then a lot run is required.

## Spiral Wrap – Mine Approved Hard Shell Hose and Cable Protection MSHA IC-271 SafeEdge™



- SafeEdge™ abrasion protection spiral wrap is manufactured from highly impact resistant high density polyethylene, and is simply wrapped over hose or cable to provide a tough protection shell to reduce abrasion damage.
- Rounded edges prevents hose and cable damage from flexing of spiral. Superior to cheaper spiral made from slit plastic pipe resulting in sharp edges.
- Available in sizes to wrap individual or bundled hoses and cables with a total ID up to 3.9 inches or 99mm.
- Stays in place without sliding. Springs back when twisted and pulled.
- MSHA IC-271 approved. Available only in a dark grey color.
- Temperature range -60 to + 175°F. Resistant to acids, oils and solvents.

SafeEdge™ High Density Polyethylene Hard Shell Spiral Wrap for Cable & Hose Abrasion Protection - MSHA IC-271 Approved						
See notes for available lengths						
Part Number	ID Size inch / mm / -dash			Pitch in inches	Wall Thickness in inches	Price per Foot
SW-HDP-MINE-0.50-M016-10-ZZZ	0.50	13	-08	0.8	.05	\$ 2.55
SW-HDP-MINE-0.63-M016-10-ZZZ	0.63	16	-10	0.8	.05	\$ 2.63
SW-HDP-MINE-0.81-M021-14-ZZZ	0.81	21	-14	1.0	.10	\$ 2.70
SW-HDP-MINE-1.06-M027-17-ZZZ	1.06	27	-17	0.9	.10	\$ 3.20
SW-HDP-MINE-1.36-M035-22-ZZZ	1.36	35	-22	.94	.11	\$ 3.83
* SW-HDP-MINE-1.70-M043-27-ZZZ	1.70	43	-27	1.2	.13	\$ 5.67
SW-HDP-MINE-2.20-M056-35-ZZZ	2.20	56	-35	1.5	.15	\$ 7.36
* SW-HDP-MINE-2.60-M066-42-ZZZ	2.60	66	-42	1.75	.17	\$ 13.27
SW-HDP-MINE-3.20-M081-51-ZZZ	3.20	81	-51	1.75	.19	\$ 20.90
SW-HDP-MINE-3.90-M099-62-ZZZ	3.90	99	-62	2.00	.22	\$ 30.26

\* For SW-HDP-MINE-1.70-M043-27-ZZZ and SW-HDP-MINE-2.60-M066-42-ZZZ, use "025", "050" or "100" for length in feet as the "ZZZ" value in the part number

For all other part numbers, the coil length is 82 feet (use 082 in the part number).

This product is made to order; typical production is 10 to 15 working days.  
Some stock lengths may exist - please call

## Spiral Wrap with Wear Indicating Layer for Hose & Cable Protection TellTale™ Hard Shell Hose and Cable Protection



- TellTale™ abrasion protection spiral wrap is manufactured from highly impact resistant high density polyethylene, and is simply wrapped over hose or cable to provide a tough protection shell to reduce abrasion damage.
- Rounded edges prevents hose and cable damage from flexing of spiral. Superior to cheaper spiral made from slit plastic pipe resulting in sharp edges.
- Available in sizes to wrap individual or bundled hoses and cables with a total ID up to 2 inches or 51mm.
- Stays in place without sliding. Springs back when twisted and pulled.
- Made from two layers of different colored material; High wear areas identified by top layer revealing yellow base layer – identifies excessive wear problems before cable or hose damage has occurred.
- Temperature range -60 to + 175°F. Resistant to acids, oils and solvents.

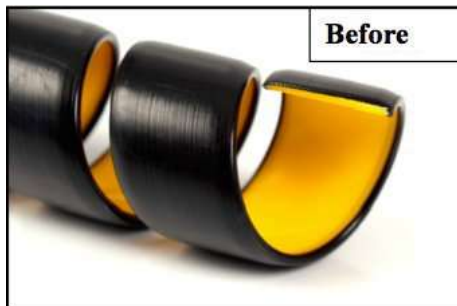



**Spiral Wrap with Wear Indicating Layer for Hose & Cable Protection (Continued)**  
**TellTale™ Hard Shell Hose and Cable Protection**



TellTale™ High Density Polyethylene Hard Shell Spiral Wrap for Cable & Hose Abrasion Protection – With Wear Indicating Layer Lengths of 100 feet						
Part Number	ID Size inch / mm / -dash			Pitch in inches	Wall Thickness in inches	Price per Coil
SW-HDP-TELL-M016-10	0.63	16	-10	0.8	.05	\$ 220.00
SW-HDP-TELL-M021-13	0.81	21	-13	1.0	.10	\$ 237.00
SW-HDP-TELL-M027-17	1.06	27	-17	0.9	.10	\$ 267.00
SW-HDP-TELL-M035-22	1.36	35	-22	.94	.11	\$ 396.00
SW-HDP-TELL-M043-27	1.70	43	-27	1.2	.13	\$ 483.00
SW-HDP-TELL-M056-35	2.20	56	-35	1.2	.13	\$ 729.00

## SafetyWrap™ Spiral Wrap for Hose & Cable Protection

High visibility protection with safety stripe reduces trip hazard



- SafetyWrap™ abrasion protection spiral wrap is manufactured from highly impact resistant high density polyethylene, and is simply wrapped over hose or cable to provide a tough protection shell to reduce abrasion damage.
- High visibility to reduce trip hazard.
- Rounded edges prevents hose and cable damage from flexing of spiral. Superior to cheaper spiral made from slit plastic pipe resulting in sharp edges.
- Used to wrap individual or bundled hoses.
- Stays in place without sliding. Springs back when twisted and pulled.
- Temperature range -60°F to +175°F. Resistant to acids, oils and solvents.

SafetyWrap™ High Density Polyethylene Hard Shell Spiral Wrap for Cable & Hose Abrasion Protection – High Visibility						
Lengths of 100 feet						
Part Number	ID Size inch / mm / -dash			Pitch in inches	Wall Thickness in inches	Price per Coil
SW-HDP-SS-0.65-M016-10	0.65	16	-10	0.8	.05	\$ 192.00
SW-HDP-SS-0.80-M020-13	0.80	20	-13	1.0	.10	\$ 207.00
SW-HDP-SS-1.10-M028-18	1.10	28	-18	0.9	.10	\$ 234.00

## InsulShrink™ Polyolefin Shrink Tubing 2:1 / 3:1 / 4:1 shrink ratios - 194°F / 90°C Shrink Temperature



- Good general chemical resistance.
- Available in 11 colors.
- Easily cut to length.
- MIL-I-23053/5
- Printing available: Logos, Part Numbers, etc.





**InsulShrink™ Polyolefin Shrink Tubing**  
**2:1 / 3:1 / 4:1 shrink ratios - 194°F / 90°C Shrink Temperature**

InsulShrink™ Polyolefin Heatshrink Tubing - 2:1 shrink ratio			
Part Number	Shrink Range Normal size → Shrunk	Spool Size & Price	
		Bulk Spool	Shop Spool
ST-P2-0.0468-XX-Y	0.0468 → 0.0234	500 ft / \$ 137.50	25 ft / \$ 8.13
ST-P2-0.0468-BR-Y	0.0468 → 0.0234	500 ft / \$ 137.50	25 ft / \$ 8.13
ST-P2-0.0625-XX-Y	0.0625 → 0.0312	500 ft / \$ 162.50	25 ft / \$ 10.00
ST-P2-0.0625-GY-Y	0.0625 → 0.0312	500 ft / \$ 162.50	25 ft / \$ 10.00
ST-P2-0.0937-XX-Y	0.0937 → 0.0468	500 ft / \$ 162.50	25 ft / \$ 10.00
ST-P2-0.1250-XX-Y	0.1250 → 0.0625	500 ft / \$ 175.00	25 ft / \$ 10.63
ST-P2-0.1875-XX-Y *	0.1875 → 0.0937	250 ft / \$ 131.25	25 ft / \$ 15.00
ST-P2-0.2500-XX-Y	0.2500 → 0.1250	250 ft / \$ 143.75	25 ft / \$ 16.25
ST-P2-0.2500-OR-Y	0.2500 → 0.1250	250 ft / \$ 143.75	25 ft / \$ 16.25
ST-P2-0.3750-XX-Y	0.3750 → 0.1875	200 ft / \$ 130.00	25 ft / \$ 18.13
ST-P2-0.5000-XX-Y	0.5000 → 0.2500	200 ft / \$ 150.00	25 ft / \$ 20.63
ST-P2-0.5000-BR-Y	0.5000 → 0.2500	200 ft / \$ 150.00	25 ft / \$ 20.63
ST-P2-0.6250-XX-Y ††††	0.6250 → 0.3125	100 ft / \$ 90.00	25 ft / \$ 25.00
ST-P2-0.7500-XX-Y	0.7500 → 0.3750	100 ft / \$ 100.00	25 ft / \$ 27.50
ST-P2-1.0000-XX-Y	1.0000 → 0.5000	100 ft / \$ 147.50	25 ft / \$ 41.25
ST-P2-1.5000-XX-Y †††††	1.5000 → 0.7500	100 ft / \$ 247.50	25 ft / \$ 68.75
ST-P2-2.0000-XX-Y	2.0000 → 1.0000	100 ft / \$ 342.50	50 ft / \$ 95.00
ST-P2-3.0000-XX-Y **	3.0000 → 1.5000	100 ft / \$ 775.00	50 ft / \$ 203.13
ST-P2-4.0000-BK-Y ***	4.0000 → 2.0000	100 ft / \$ 1000.00	25 ft / \$ 265.63

\* Only available in Black and Clear. \*\* Only available in Black, Clear, Green, Green/Yellow Striped, White, Yellow.  
 \*\*\* Only available in Black. ††††† Black, Clear, Orange, Red, White, Yellow pricing supplement. ††††† Green, Gray, Orange, Purple, Yellow pricing supplement.

For the "XX" value in the part number: specify **WH** - White; **BK** - Black; **GY** - Gray; **RD** - Red; **OR** - Orange; **YL** - Yellow; **GN** - Green; **BL** - Blue; **PP** - Purple; **BR** - Brown; **YG** - Yellow/Green Striped; **CL** - Clear

For the "Y" value in the part number: specify "B" for Bulk Spool or "S" for Shop Spool

WARNING: This product can expose you to chemicals including: antimony trioxide, known to the State of California to cause cancer and birth defects or other reproductive harm. For more information go to [www.P65Warnings.ca.gov](http://www.P65Warnings.ca.gov)

**InsulShrink™ Polyolefin Shrink Tubing**  
**2:1 / 3:1 / 4:1 shrink ratios - 194°F / 90°C Shrink Temperature**

<b>InsulShrink™ Polyolefin Heatshrink Tubing - 3:1 shrink ratio</b>			
<b>Part Number</b>	<b>Shrink Range Normal size → Shrunk</b>	<b>Spool Size &amp; Price</b>	
		<b>Bulk Spool</b>	<b>Shop Spool</b>
ST-P3-0.0625-XX-Y	0.062 → 0.020	500 ft / \$ 225.00	25 ft / \$ 14.37
ST-P3-0.1250-XX-Y	0.125 → 0.041	500 ft / \$ 262.50	25 ft / \$ 15.62
ST-P3-0.1875-XX-Y	0.187 → 0.062	250 ft / \$ 187.50	25 ft / \$ 20.62
ST-P3-0.2500-XX-Y	0.250 → 0.083	250 ft / \$ 212.50	25 ft / \$ 23.75
ST-P3-0.3750-XX-Y	0.375 → 0.125	200 ft / \$ 195.00	25 ft / \$ 26.87
ST-P3-0.5000-XX-Y	0.500 → 0.166	200 ft / \$ 215.00	25 ft / \$ 30.00
ST-P3-0.7500-XX-Y	0.750 → 0.250	100 ft / \$ 145.00	25 ft / \$ 40.00
ST-P3-1.0000-XX-Y	1.000 → 0.333	100 ft / \$ 215.00	25 ft / \$ 59.37
ST-P3-1.5000-XX-Y	1.500 → 0.500	100 ft / \$ 397.50	25 ft / \$ 110.63
ST-P3-2.0000-XX-Y	2.000 → 0.666	100 ft / \$ 960.00	25 ft / \$ 266.87
ST-P3-3.0000-XX-Y	3.000 → 1.000	100 ft / \$ 1832.50	25 ft / \$ 500.00

For the "XX" value in the part number: specify **WH** - White; **BK** - Black; **GY** - Gray; **RD** - Red; **OR** - Orange; **YL** - Yellow; **GN** - Green; **BL** - Blue; **PP** - Purple; **BR** - Brown; **YG** - Yellow/Green Striped; **CL** - Clear

For the "Y" value in the part number: specify "B" for Bulk Spool or "S" for Shop Spool

<b>InsulShrink™ Polyolefin Heatshrink Tubing - 4:1 shrink ratio</b>			
<b>Part Number</b>	<b>Shrink Range Normal size → Shrunk</b>	<b>Spool Size &amp; Price</b>	
		<b>Bulk Spool</b>	<b>Shop Spool</b>
ST-P4-0.5000-XX-Y	0.500 → 0.125	200 ft / \$ 615.00	25 ft / \$ 83.75
ST-P4-0.7500-XX-Y	0.750 → 0.187	100 ft / \$ 537.50	25 ft / \$ 145.63
ST-P4-1.0000-XX-Y	1.000 → 0.250	100 ft / \$ 962.50	25 ft / \$ 260.63
ST-P4-1.2500-XX-Y	1.250 → 0.312	100 ft / \$ 1057.50	25 ft / \$ 286.25
ST-P4-1.5000-XX-Y	1.500 → 0.375	100 ft / \$ 1155.00	25 ft / \$ 312.50

For the "XX" value in the part number: specify **WH** - White; **BK** - Black; **GY** - Gray; **RD** - Red; **OR** - Orange; **YL** - Yellow; **GN** - Green; **BL** - Blue; **PP** - Purple; **BR** - Brown; **YG** - Yellow/Green Striped; **CL** - Clear

For the "Y" value in the part number: specify "B" for Bulk Spool or "S" for Shop Spool

**WARNING:** This product can expose you to chemicals including: antimony trioxide, known to the State of California to cause cancer and birth defects or other reproductive harm. For more information go to [www.P65Warnings.ca.gov](http://www.P65Warnings.ca.gov)



## InsulShrink™ Polyolefin Dual Wall Shrink Tubing with Adhesive 2:1 / 3:1 / 4:1 shrink ratios - 194°F / 90°C Shrink Temperature



- Good general chemical resistance.
- Available in 4 foot sticks.
- Easily cut to length.
- MIL-I-23053/5
- Printing available: Logos, Part Numbers, etc.



InsulShrink™ Polyolefin Dual Wall Heatshrink Tubing with Adhesive 2:1 shrink ratio			
Part Number	Shrink Range Normal size → Shrunk	Price	
			4' stick
ST-P2-HDA-0.1250-XX	0.1250 → 0.0625		\$ 4.72
ST-P2-HDA-0.2500-XX	0.2500 → 0.1250		\$ 5.25
ST-P2-HDA-0.3750-XX	0.3750 → 0.1875		\$ 7.25
ST-P2-HDA-0.5000-XX	0.5000 → 0.2500		\$ 9.47
ST-P2-HDA-0.7500-XX	0.7500 → 0.3750		\$ 12.25
ST-P2-HDA-1.0000-XX	1.0000 → 0.5000		\$ 19.00
ST-P2-HDA-1.5000-XX	1.5000 → 0.7500		\$ 25.87

Available in Black, Clear, White and Red

For the "XX" value in the part number: specify **WH** - White; **BK** - Black; **RD** - Red; **CL** - Clear

**InsulShrink™ Polyolefin Dual Wall Shrink Tubing with adhesive**  
**2:1 / 3:1 / 4:1 shrink ratios - 194°F / 90°C Shrink Temperature**

<b>InsulShrink™ Polyolefin Dual Wall Heatshrink Tubing with Adhesive</b>			
<b>3:1 shrink ratio</b>			
<b>Part Number</b>	<b>Shrink Range Normal size → Shrunk</b>	<b>Price</b>	
			<b>4' Stick</b>
ST-P3-HDA-0.1250-XX	0.125 → 0.041		\$ 5.25
ST-P3-HDA-0.1875-XX	0.187 → 0.062		\$ 5.37
ST-P3-HDA-0.2500-XX	0.250 → 0.083		\$ 5.85
ST-P3-HDA-0.3750-XX	0.375 → 0.125		\$ 8.05
ST-P3-HDA-0.5000-XX	0.500 → 0.166		\$ 10.52
ST-P3-HDA-0.7500-XX	0.750 → 0.250		\$ 13.62
ST-P3-HDA-1.0000-XX	1.000 → 0.333		\$ 21.10
ST-P3-HDA-1.5000-XX	1.500 → 0.500		\$ 28.75
ST-P3-HDA-2.0000-XX	2.000 → 0.666		\$ 38.75

Available in Black, Clear, White and Red

For the "XX" value in the part number: specify **WH** - White; **BK** - Black; **RD** - Red; **CL** - Clear

<b>InsulShrink™ Polyolefin Dual Wall Heatshrink Tubing with Adhesive</b>			
<b>4:1 shrink ratio</b>			
<b>Part Number</b>	<b>Shrink Range Normal size → Shrunk</b>	<b>Price</b>	
			<b>4' stick</b>
ST-P4-HDA-0.1875-XX	0.187 → 0.062		\$ 6.00
ST-P4-HDA-0.3125-XX	0.312 → 0.078		\$ 9.40
ST-P4-HDA-0.5000-XX	0.500 → 0.125		\$ 12.30
ST-P4-HDA-0.7500-XX	0.750 → 0.187		\$ 14.37
ST-P4-HDA-1.0000-XX	1.000 → 0.250		\$ 24.00
ST-P4-HDA-1.2500-XX	1.250 → 0.312		\$ 29.00
ST-P4-HDA-2.0000-XX	2.000 → 0.500		\$ 60.00

Available in Black, Clear

For the "XX" value in the part number: specify **BK** - Black; **CL** - Clear

WARNING: This product can expose you to chemicals including: antimony trioxide, known to the State of California to cause cancer and birth defects or other reproductive harm. For more information go to [www.P65Warnings.ca.gov](http://www.P65Warnings.ca.gov)



**InsulShrink™ PVC Heat Shrink Tubing**  
**2:1 shrink ratios - 392°F / 200°C Maximum Operating Temperature**

- Good general chemical resistance.
- Available in black only.
- Easily cut to length.
- MIL-I-23053/5
- Shrink temperature 347°F / 175°C

<b>InsulShrink™ PVC Heat-Shrink Tubing - 2:1 shrink ratio</b>			
<b>Part Number</b>	<b>Shrink Range Normal size → Shrunk</b>	<b>Spool Size &amp; Price</b>	
		<b>Bulk Spool</b>	<b>Shop Spool</b>
ST-VIT2-0.1250-XX-Y	0.125 → 0.041	200 ft / \$ 765.00	25 ft / \$ 108.12
ST-VIT2-0.1875-XX-Y	0.187 → 0.062	200 ft / \$ 805.00	25 ft / \$ 113.12
ST-VIT2-0.2500-XX-Y	0.250 → 0.083	200 ft / \$ 840.00	25 ft / \$ 117.50
ST-VIT2-0.3750-XX-Y	0.375 → 0.125	200 ft / \$ 1005.00	25 ft / \$ 138.12
ST-VIT2-0.5000-XX-Y	0.500 → 0.166	100 ft / \$ 702.50	25 ft / \$ 188.12
ST-VIT2-0.6250-XX-Y	0.625 → 0.166	100 ft / \$ 902.50	25 ft / \$ 238.12
ST-VIT2-0.7500-XX-Y	0.750 → 0.250	100 ft / \$ 1102.50	25 ft / \$ 288.12
ST-VIT2-0.8750-XX-Y	0.875 → 0.250	50 ft / \$ 712.50	25 ft / \$ 368.75
ST-VIT2-1.0000-XX-Y	1.000 → 0.333	50 ft / \$ 802.50	25 ft / \$ 413.75
ST-VIT2-1.2500-XX-Y	1.250 → 0.333	50 ft / \$ 1203.75	25 ft / \$ 614.37
ST-VIT2-1.5000-XX-Y	1.500 → 0.500	50 ft / \$ 1236.25	25 ft / \$ 630.62
ST-VIT2-2.0000-XX-Y	2.000 → 0.666	50 ft / \$ 3375.00	25 ft / \$ 1700.00

## InsulShrink™ Viton Heat Shrink Tubing 2:1 shrink ratios - 392°F / 200°C Maximum Operating Temperature



- Good general chemical resistance.
- Available in black only.
- Easily cut to length.
- MIL-I-23053/5
- Shrink temperature 347°F / 175°C

InsulShrink™ Viton® Heat-Shrink Tubing - 2:1 shrink ratio			
Part Number	Shrink Range Normal size → Shrunk	Spool Size & Price	
		Bulk Spool	Shop Spool
ST-VIT2-0.1250-XX-Y	0.125 → 0.041	200 ft / \$ 765.00	25 ft / \$ 108.12
ST-VIT2-0.1875-XX-Y	0.187 → 0.062	200 ft / \$ 805.00	25 ft / \$ 113.12
ST-VIT2-0.2500-XX-Y	0.250 → 0.083	200 ft / \$ 840.00	25 ft / \$ 117.50
ST-VIT2-0.3750-XX-Y	0.375 → 0.125	200 ft / \$ 1005.00	25 ft / \$ 138.12
ST-VIT2-0.5000-XX-Y	0.500 → 0.166	100 ft / \$ 702.50	25 ft / \$ 188.12
ST-VIT2-0.6250-XX-Y	0.625 → 0.166	100 ft / \$ 902.50	25 ft / \$ 238.12
ST-VIT2-0.7500-XX-Y	0.750 → 0.250	100 ft / \$ 1102.50	25 ft / \$ 288.12
ST-VIT2-0.8750-XX-Y	0.875 → 0.250	50 ft / \$ 712.50	25 ft / \$ 368.75
ST-VIT2-1.0000-XX-Y	1.000 → 0.333	50 ft / \$ 802.50	25 ft / \$ 413.75
ST-VIT2-1.2500-XX-Y	1.250 → 0.333	50 ft / \$ 1203.75	25 ft / \$ 614.37
ST-VIT2-1.5000-XX-Y	1.500 → 0.500	50 ft / \$ 1236.25	25 ft / \$ 630.62
ST-VIT2-2.0000-XX-Y	2.000 → 0.666	50 ft / \$ 3375.00	25 ft / \$ 1700.00



**High Temperature, Heat, Flame, Fire, Molten Metal & Weld Splatter Protection Materials**

*Fax Orders: 610-340-9054 Telephone Orders: 610-906-3549 [orders@abthermal.com](mailto:orders@abthermal.com)*

---



# Custom Fabrications & Fabrication Supplies

Portable Equipment Lithium-Ion Battery Fire Containment Bags - meets FAA & EASA standards .....	7-1
Pallet Cargo Fire Containment Cover - FAA TSO-C203 Approved .....	7-3
Welding Blankets & Curtains .....	7-5
Plumbing / Grinding / Light Welding Protection Pads .....	7-8
High Temperature & Heat Resistant Kneeling Pads .....	7-9
Annealing Pads for Glass and Metal Processing .....	7-10
Removable Blanket & Insulation Systems for Engine & Generator Exhaust Components .....	7-11
Removable Blanket & Insulation System Example Pricing .....	7-13
Standard Blanket Sets .....	7-15
Caterpillar Engines .....	7-15
Cummins Engines .....	7-16
Daewoo Engines .....	7-16
Daimler Chrysler Engines .....	7-17
Detroit Diesel .....	7-17
Deutz Diesel Engines .....	7-18
EMD Electro-Motive Diesel Engines .....	7-18
Ford Engines .....	7-18
GM General Motors Engines .....	7-18
Hercules Engines .....	7-15
Isuzu Engines .....	7-15
Iveco Engines .....	7-15
John Deere Engines .....	7-15
Kubota Engines .....	7-16
Lister Petter Engines .....	7-16
Lombardini Engines .....	7-16
Mercedes Engines .....	7-16
Merlin Engines .....	7-16
Mitsubishi Engines .....	7-17
Nissan Engines .....	7-17
Onan Cummins Engines .....	7-17
Perkins Engines .....	7-18
Pielstick Engines .....	7-18
Spectrum Engines .....	7-18
Stork Engines .....	7-19
Superior Engines .....	7-19
VM Motori Engines .....	7-19
Volvo Engines .....	7-19
Wartsila Engines .....	7-19
Waukesha Engines .....	7-19
Yanmar Engines .....	7-19
Standard Genset Blanket Sets .....	7-20
Caterpillar Gensets .....	7-20
Generac Gensets .....	7-20
Kohler Gensets .....	7-21

# High Temperature, Heat, Flame, Fire, Molten Metal & Weld Splatter Protection Materials

Fax Orders: 610-340-9054 Telephone Orders: 610-906-3549 [orders@abthermal.com](mailto:orders@abthermal.com)

---

---

Kubota Gensets .....	7-22
Olympian Gensets .....	7-22



## Thermal, EMI/RFI & Abrasion Protection Materials

Fax Orders: 610-340-9054 Telephone Orders: 610-906-3549 [orders@abthermal.com](mailto:orders@abthermal.com)

Standard Selective Catalytic Reduction Units .....	7-23
Steuler .....	7-23
CAT .....	7-23
Cummins .....	7-23
Siemens .....	7-23
Argillon .....	7-23
Standard Agricultural, Construction, Mining, Logging Vehicle Engine Blanket Sets .....	7-24
Atlas Copco .....	7-24
BTI .....	7-24
Case .....	7-24
Caterpillar CAT .....	7-24
Cubex .....	7-25
Dodge .....	7-25
Getman .....	7-25
Jarvis Clarke .....	7-25
John Deere .....	7-25
Komatsu .....	7-25
MACK .....	7-26
Maclean .....	7-26
Marcotte .....	7-26
Miller .....	7-26
Mine Jack .....	7-26
Mixmaster .....	7-26
MTI .....	7-26
New Holland .....	7-27
Norment .....	7-27
Omega .....	7-27
REG .....	7-27
Robbins Rasiebore .....	7-27
Tamrock .....	7-27
Toro .....	7-27
Volvo .....	7-27
Wagner .....	7-27
Wajax .....	7-28

# High Temperature, Heat, Flame, Fire, Molten Metal & Weld Splatter Protection Materials

Fax Orders: 610-340-9054 Telephone Orders: 610-906-3549 [orders@abthermal.com](mailto:orders@abthermal.com)

---

---

Quote Request Forms for Engine Component Insulation Blankets .....	7-29
Fire Protection Removable Blanket and Shield Insulation Systems for Mine Equipment .....	7-34
Removable Insulation Covers for Industrial / Marine Valves & Piping .....	7-35
Blow-out / Spray Protection Shields for Valves & Pipe Flanges .....	7-36
Steel and Metal Processing Plant Custom Fabrications .....	7-37
Heated Removable Insulation Covers for Gas Cylinders .....	7-38
Heated Removable Insulation Covers and Heating Pads for Industrial Bulk Container Tote Tanks .....	7-39
55 & 30 Gallon Drum Insulated Covers & Covers with Heaters .....	7-40
Silicone Rubber Pipe & Hose Heating Tape with Fixed Thermostat .....	7-41
Silicone Rubber Pipe & Hose Heating Tape with Adjustable Thermostat .....	7-42
ECOtherm Blanket .....	7-43
Robotic Covers .....	7-44
Steam Trap Jackets .....	7-45
Conveyor Belting .....	7-46
High Temperature Heat Resistant Threads .....	7-47
Hook & Loop Closure Fasteners .....	7-51
High Temperature Zippers .....	7-55
Scissors / Shears / Cutters .....	7-56
Stainless Steel Snaps .....	7-57
Commercial Kitchen Duct Sealant, Gaskets & Access Doors .....	7-58



## Thermal, EMI/RFI & Abrasion Protection Materials

Fax Orders: 610-340-9054 Telephone Orders: 610-906-3549 [orders@abthermal.com](mailto:orders@abthermal.com)

---

---





## ThermaCover™ Portable Equipment Lithium-Ion Battery Fire Containment Bags - meets FAA & EASA standards



- Designed for Laptops, Notebooks, Tablets, Cellphones, Portable Game Devices and other objects powered by Lithium-ion batteries.
- Will not burn, melt or allow flame penetration.
- Resists molten metal burn through.
- Withstands temperatures up to 1800°F / 980°C.
- Kit includes the bag, high temperature gloves and a fireblanket.
- The bag is available in tote or envelope style.
- Tote dimensions are 24" x 13" x 5". Envelope dimensions are 16" x 18" and 18" x 24".
- Both styles feature a multi-layer design of fire resistant fabric and aluminum foil coated fabric to ensure heat and fire remain contained.
- The gloves feature a leather palm and aluminized backing to provide protection and flexible grip with maximum dexterity.
- The fireblanket is designed to knock down flames before the handler grasps the burning device.
- Meets or exceeds the following standards:
  - FAR 25 Appendix F Part 1 (Horizontal Rate of Burning)
  - FAR 25 Appendix F Part III (Flame Penetration Resistance)
  - FAR 25 Appendix F Part IV (Heat Release Rate)
  - FAR 25 Appendix F Part V (Smoke Density)
  - ASTM D6413 (Vertical Flame Resistance)
  - ASTM E-84 (Surface Flame Spread and Smoke Density)
  - ASTM F-955 (Molten Metal Resistance)
  - ASTM E-119 (Furnace Tested)
  - UL 1784 (Smoke Penetration)
  - BSS 7239 (Non-Toxicity of Products of Combustion)

**Portable Equipment Lithium-Ion Battery Fire Containment Bags  
(Continued)**

**Exceeds fire suppression standards set by FAA, EASA**



<b>ThermaCover™ Fire Containment Bags for Lithium-ion Battery Powered Portable Equipment</b>		
<b>Part Number</b>	<b>Size inch / cm</b>	<b>Price</b>
FAB-FCB-16X18	16" x 18" / 40.6 x 45.7	\$ 744.56
FAB-FCB-18X24	18" x 24" / 45.7 x 60.9	\$ 873.24
FAB-FCB-TOTE	24" x 13" x 5" / 61 x 33 x 13	\$ 1093.23

## PalletGard™ Pallet Cargo Fire Containment Cover

TSO-C203 FAA Approved



- Designed to isolate a pallet fire for 6 hours - providing valuable time to land safely.
- Exceeds the performance standards set by the FAA and EASA.
- Lightweight, durable, easy to deploy and maintain.
- Features a cross shaped design with overlapping corners for ease of use with irregular loads.
- Provides extended protection from extreme heat and flames caused by fuel sources such as lithium-ion batteries and hazardous cargo.
- Designed to be used with a standard TSO-C90 cargo net.
- Locking net connectors.
- Used for aviation, marine, land transport and storage in hangars, and other structures.
- Will not burn, melt or allow flame penetration.
- Resists molten metal burn through.
- Withstands temperatures up to 1800°F / 980°C.
- 3 standard sizes and custom sizes available.
- Also useable to prevent fire from damaging the pallet contents for valuable equipment, and currency.
- Meets or exceeds the following standards:
  - TSO-C203 (FAA Fire Containment Cover Certification)
  - ISO 14186 / SAE AS 6453 (Full Scale Box Burn)
  - ISO 12236 (Static Puncture Test)
  - FAR 25 Appendix F Part III (Flame Penetration Resistance)
  - FAR 25 Appendix F Part IV (Heat Release Rate)
  - FAR 25 Appendix F Part V (Smoke Density)
  - ASTM D6413 (Vertical Flame Resistance)
  - ASTM E-84 (Surface Flame Spread and Smoke Density)
  - ASTM F-955 (Molten Metal Resistance)
  - ASTM E-119 (Furnace Tested)
  - UL 1784 (Smoke Penetration)
  - BSS 7239 (Non-Toxicity of Products of Combustion)

**PalletGard™ Pallet Fire Containment Cover**

**TSO-C203 FAA Approval**



<b>PalletGard™ Pallet Fire Containment Cover - TSO-C203</b>		
<b>Part Number</b>	<b>Size inch / cm</b>	<b>Price</b>
FAB-PFCC-126X98X118	126" x 98" x 118" / 320 x 249 x 299	\$ 5987.55
FAB-PFCC-126X98X96	126" x 96" x 96" / 320 x 249 x 244	\$ 5673.87
FAB-PFCC-126X98X64	126" x 98" x 64" / 320 x 249 x 162	\$ 4757.38

Custom sizes are available but do not meet TSO.

Custom sizes meeting TSO will incur testing costs.





## **Welding Splatter and Spark Protection Blankets & Curtains** **Light Duty - Medium Duty - Heavy Duty**

Industrial hot work welding and cutting continues to be one of the leading cause of fires and explosions. AB Tech's FlameShield™ FM tested, approved and certified blanket and curtain materials and products protects property, equipment and people from the inadvertant ignition of combustibles.

FlameShield™ products meet the specific requirements as set by FM, and provide superior protection to products that have no certification.

FM's Follow-Up Audits ensures that the ongoing performance of AB Tech's fire resistance products are consistently uniform, durable and reliable.

AB Tech's welding protection products range from cost effective lightweight curtain materials for containment of sparks and arc-flash to heavy duty, long-service fabrics to shield against molten slag. Our welding materials are made of incombustible fiberglass, silica and aramid cloth and are available uncoated or with a specially formulated treatments to resist water, oil, harsh chemicals, fire and abrasion. They are flexible, drapable, easy to cut and stitch for the widest possible applications.

FlameShield™ welding blankets and welding curtains have been evaluated on their ability to:

- Prevent burn through the material and provide adequate protection for adjacent combustible from possible sources of ignition;
- Limit temperature transmission through the material to a degree that will prevent ignition to underlying combustibles;
- Resist melting, dripping or deformation so as to prevent sparks from spreading outside of confined and protected areas;
- Maintain their flexibility, durability and structural integrity when charred areas are subject to 90 degree bends;
- Maintain their fire and temperature rise resistance properties when subjected to accelerated weathering tests intended to stimulate exposure to light and water (ultra violet [uv] and condensation, respectively) conditions.

These blankets and curtains may be draped over equipment or cabling/hoses to protect against welding and grinding operations, or may be hung as a curtain to protect an area. May also be hung as a canopy or false ceiling to provide shielding from hot process piping or overhead repairs and fabrication work.

A variety of fabrics are available: Fiberglass and Silica based - plain, and with coatings.

Lower cost lightweight fiberglass materials, with simple acrylic, neoprene and silicone coatings can be utilized for light duty applications in a vertical installation - where weld splatter and sparks hit the fabric and then fall to the floor or ground - the coatings only need to protect the fabric material briefly during the short contact cycle.

For medium duty applications - heavier weight fiberglass fabrics with thicker and heavier coatings provide good burn through protection in a lower cost and lighter material than the heavy duty protection materials.

For heavy duty applications involving large amounts of splatter and sparks, and repeated contact in a concentrated area, the heaviest fiberglass and heaviest coating materials provide long life. For the ultimate in burn-through protection, and for horizontal placement where the splatter can rest or accumulate on the blanket, silica fabrics are preferred due to the excellent burn-through protection they provide.

We can fabricate custom blankets, curtains and shields for your specific application, with a variety of attachment and extension options.



## Welding Splatter and Spark Protection Blankets & Curtains Light Duty - Medium Duty - Heavy Duty

<b>Welding Blankets / Curtains</b>		
<b>Using FlameShield FCB 1000°F / 537°C Fabric</b>		
<b>Part Number</b>	<b>Size feet / metres</b>	<b>Price</b>
FAB-WBC-46-FB	4 x 6 / 1.2 x 1.8	\$ 145.43
FAB-WBC-66-FB	6 x 6 / 1.8 x 1.8	\$ 176.80
FAB-WBC-88-FB	8 x 8 / 2.4 x 2.4	\$ 328.90
FAB-WBC-810-FB	8 x 10 / 2.4 x 3.0	\$ 398.60
FAB-WBC-1010-FB	10 x 10 / 3.0 x 3.0	\$ 485.77
FAB-WBC-1015-FB	10 x 15 / 3.0 x 4.5	\$ 697.67

<b>Using FlameShield FCBHT (pre-shrunk) 1000°F / 537°C Fabric</b>		
FAB-WBC-66-FBHT	6 x 6 / 1.8 x 1.8	\$ 202.16
FAB-WBC-88-FBHT	8 x 8 / 2.4 x 2.4	\$ 374.68
FAB-WBC-810-FBHT	8 x 10 / 2.4 x 3.0	\$ 458.32
FAB-WBC-1010-FBHT	10 x 10 / 3.0 x 3.0	\$ 582.92
FAB-WBC-1015-FBHT	10 x 15 / 3.0 x 4.5	\$ 834.40

<b>Using InSilMax ISCB 1800°F / 982°C Fabric</b>		
FAB-WBC-66-ETB90	6 x 6 / 1.8 x 1.8	\$ 390.73
FAB-WBC-88-ETB90	8 x 8 / 2.4 x 2.4	\$ 693.53
FAB-WBC-810-ETB90	8 x 10 / 2.4 x 3.0	\$ 860.47
FAB-WBC-1010-ETB90	10 x 10 / 3.0 x 3.0	\$ 1074.30
FAB-WBC-1015-ETB90	10 x 15 / 3.0 x 4.5	\$ 1612.43

- Meets NFPA 701 / CPAI-84
- All Welding Blankets / Curtains are fabricated from a single layer of material.
- All outside edges are serged / overlapped to prevent fraying.
- Folded / stitched edges are available at extra charge.
- ½" Grommets are available at \$8.00 each, at any spacing desired.

For Custom Sizes Please Enquire

**Plumbing / Grinding / Welding Protection Pads**

**1800°F / 982°C InSilMax™ Fabric**



These mini pads are fabricated from Extreme High Temperature InSilMax™ Cloth, with serged / overlapped edges to prevent fraying, and with one edge folded and sewn and also grommeted at two corners.

Can be hung or tacked behind welding, grinding or soldering work to protect walls, wiring, hoses, etc. from being damaged during maintenance or fabrication work.

Also used as annealing pads in tempering ovens for metal fabrications.

These pads pay for themselves very quickly by preventing costly damage that could have been easily avoided.

<b>InSilMax™ Silica Cloth Plumber / Welder Pads</b>		
<b>Part Number</b>	<b>Size - Thickness inches</b>	<b>Price</b>
FAB-WPI-810-090	8" x 10" / .090"	\$ 14.48
FAB-WPI-810-054	8" x 10" / .054"	\$ 11.17
FAB-WPI-1012-090	10" x 12" / .090"	\$ 17.87
FAB-WPI-1012-054	10" x 12" / .054"	\$ 14.48

## High Temperature & Heat Resistant Kneeling Pads

1800°F / 982°C InSilMax™



These kneeling pads are fabricated from Extreme High Temperature InSilMax™ Cloth, with Extreme High Temperature Silica Insulation sandwiched between the layers.

Very popular in steel plants, boiler industry, and can be used anywhere that a pad is required for personnel comfort and safety that will not burn and will withstand welding slag, grinding, torch flame and other hazards.

Three standard sizes are available or custom made to any size.

<b>InSilMax™ ThermalShield Kneeling Pad</b>		
<b>Part Number</b>	<b>Size</b>	<b>Price</b>
FAB-KPI-1818	18" x 18"	\$ 185.34
FAB-KPI-2424	24" x 24"	\$ 263.50
FAB-KPI-3636	36" x 36"	\$ 334.00



## Annealing Pads for Glass and Metal Processing

1800°F / 982°C InSiIMax™ Fabric



Annealing pads are fabricated to your custom size requirement.

For maximum life, the edges are serged/overlocked or folded and stitched.

Please contact us with dimensions required.

## Removable Blanket and Insulation Systems for Engine & Generator Exhaust Components – UL2200 Qualifyable

1200°F / 648°C

Diesel, Gasoline/Petrol and Natural Gas Piston and Gas Turbine Engines

*Suitable for Land, Marine and Mobile Equipment – Insulating Blankets for Mufflers, Silencers, Turbo Chargers, Elbows, Flex Pipes, Straight Pipes and Flanges*



- Removable blankets protect personnel from contact burns.
- Helps maintain exhaust temperature for better exhaust flow.
- Helps to keep engine/generator room, compartment or enclosure cooler.
- Silicone Rubber coated outer fabric meets Mil-I-24244 for corrosion and chloride requirements.
- Needled fiberglass insulation layer meets Mil-I-16411 (Type II), ASTM-C-1086-96 & USCG 164.009 for incombustible materials and MIL-I-24244 for corrosion and chloride requirements.
- Assembled with PTFE coated fiberglass thread meeting C-20079H, Type III, Class 3.
- Stainless mesh is a 304 grade. Other grades and Inconel available.
- Completed blankets allow installations to meet UL2200 with proper installation.

- Suitable for gasoline & diesel reciprocating engines. Higher temperature version available for gas turbine engines.
- Removable blanket sections are assembled with either locking wire or spring clips connecting the mushroom rivets or hook fasteners that are mounted on the blankets. (mushroom rivets visible on example at left.). Custom made to form fit components.
- Hot side layer is a stainless steel knitted mesh fabric to hold the insulation in place.
- The insulation is a DeltaGlass™ needled fiberglass or ceramic felt. Most blankets are 1" thick but can be thinner or thicker to accommodate particular thermal or dimensional requirements.
- Cold side cover fabric is typically a 2 side silicone rubber coated FlameShield™ fiberglass (silver/gray is standard, red and black available). Optionally a silicone rubber / aluminum film Dual-Coat™ coated fabric can be used or a one side coated AluMax™ aluminum film fabric.



For higher temperature operation on gas turbine engines; 1) the stainless knitted mesh is replaced with inconel mesh; 2) the needled DeltaGlass™ is replaced with needled InSilMax™; 3) the cold side fabric may be replaced with an InSilMax™ fabric.



Closure of the blankets is accomplished with stainless lock wire connecting the mushroom cap rivets. Other closure systems are available, such as spring, straps with high temperature hook and loop closure, turnbuckles or straps with D rings.

Laser etched data plates are affixed to each blanket section, identifying your order number and the component; allowing for easy installation and future replacement if necessary.

See our web site for many examples of installations and for forms to record your equipment dimensions to email or fax to us for a quote.

**Can I touch it? - Insulation surface temperatures**

We are often asked how hot the outer surface of an insulation blanket gets, and whether it is touch-safe.

To properly answer this question, it is important to remember that metals conduct heat; fabrics do not. This means that a fabric surface can be "hotter" temperature-wise than a metal surface and still be touch-safe. However, until 1998, there was no formal differentiation made between metal and other types of surfaces. For both, 140°F [60°C] was the accepted standard.

The UL2200 Specification for Stationary Engine Generator Assemblies, issued in September 1998, was the first authority to actually quantify acceptable temperatures.

**UL2200 Specification for Stationary Engine Generator Assemblies**

Contact Surface	Metallic	Nonmetallic
Handles or knobs grasped for holding	50° C (122° F)	60° C (140° F)
Handles or knobs that are contacted but do not involve holding; other surfaces subject to contact and user maintenance	60° C (140° F)	85° C (185° F)
Surfaces subject to casual contact	70° C (158° F)	95° C (203° F)

As you can see from the above table, non-metallic surfaces, such as standard insulation blankets, can reach temperatures as high as 95° C (203° F) and still be considered safe for casual contact.

Although space considerations will sometimes limit the thickness of an insulation blanket, and thus allow for a higher than desired outer surface temperature, in general, all our industrial insulation blankets are designed to be touch-safe.

## Removable Blanket and Insulation System Example Pricing

**1200°F / 648°C for Diesel, Gasoline/Petrol and Natural Gas Piston and Gas Turbine Engines**

***Suitable for Land, Marine and Mobile Equipment – Insulating Blankets for Mufflers, Silencers, Turbo Chargers, Elbows, Flex Pipes, Straight Pipes and Flanges***

### Example Pricing

Removable Blankets for Schedule Pipe – Example Pricing		
Part Number	Size	Price
FAB-EE-1200-2IDX12	2" ID x 12" (Straight Pipe)	\$ 74.67
FAB-EE-1200-2IDX24	2" ID x 24" (Straight Pipe)	\$ 109.76
FAB-EE-1200-2IDX36	2" ID x 36" (Straight Pipe)	\$ 167.38
FAB-EE-1200-2IDX48	2" ID x 48" (Straight Pipe)	\$ 221.16
FAB-EE-1200-3IDX12	3" ID x 12" (Straight Pipe)	\$ 84.38
FAB-EE-1200-3IDX24	3" ID x 24" (Straight Pipe)	\$ 146.74
FAB-EE-1200-3IDX36	3" ID x 36" (Straight Pipe)	\$ 217.68
FAB-EE-1200-3IDX48	3" ID x 48" (Straight Pipe)	\$ 261.33
FAB-EE-1200-4IDX6	4" ID x 6" (Straight Pipe)	\$ 53.75
FAB-EE-1200-4IDX12	4" ID x 12" (Straight Pipe)	\$ 89.77
FAB-EE-1200-4IDX24	4" ID x 24" (Straight Pipe)	\$ 155.58
FAB-EE-1200-4IDX36	4" ID x 36" (Straight Pipe)	\$ 217.18
FAB-EE-1200-4IDX48	4" ID x 48" (Straight Pipe)	\$ 264.38
FAB-EE-1200-4IDX72	4" ID x 72" (Straight Pipe)	\$ 380.37
FAB-EE-1200-4IDL90R4	4" Short 90 Elbow R=4"	\$ 111.28
FAB-EE-1200-5IDX12	5" ID x 12" (Straight Pipe)	\$ 97.47
FAB-EE-1200-5IDX24	5" ID x 24" (Straight Pipe)	\$ 169.98
FAB-EE-1200-5IDX36	5" ID X 36" (Straight Pipe)	\$ 225.92
FAB-EE-1200-5IDX36	5" ID X 48" (Straight Pipe)	\$ 311.38
FAB-EE-1200-6IDX60	6" ID x 60" (Straight Pipe)	\$ 367.93
FAB-EE-1200-36X48	36" x 48" Pad	\$ 436.61

Note: 2" ID schedule pipe is 2.375" OD; 3" ID pipe is 3.5" OD; 4" ID pipe is 4.5" OD, etc.

Please use our templates on the following pages to submit your installation for a price quote.

We can also work from tables of dimensions, photos with dimensions annotated over the images, or sketches/drawings. See our website for more examples.



## Example Pricing

Removable Blankets for Schedule Pipe – Example Pricing		
Part Number	Size	Price
FAB-EE-1200-24IDX60	24" ID x 60" (Straight Pipe)	\$ 996.67
FAB-EE-1200-14IDX60	14" ID x 60" (Straight Pipe)	\$ 641.52
FAB-EE-1200-10.75IDX60	10.75" ID x 60" (Straight Pipe)	\$ 597.21
FAB-EE-1200-4.5IDX72	4.5" ID x 72" (Straight Pipe)	\$ 397.55

Note: 2" ID schedule pipe is 2.375" OD; 3" ID pipe is 3.5" OD; 4" ID pipe is 4.5" OD, etc.

Please use our templates on the following pages to submit your installation for a price quote.

We can also work from tables of dimensions, photos with dimensions annotated over the images, or sketches/drawings. See our website for more examples.



## Removable Blanket and Insulation Systems for Engine & Generator Exhaust Components – UL2200 1200°F / 648°C

### Diesel, Gasoline/Petrol and Natural Gas Piston and Gas Turbine Engines

Standard engine insulation blanket sets for the following engine makes and models are available (The Part Number is the ordering code for the complete set for that engine.)

Please enquire for models not listed: we can custom fabricate for any engine configuration.

### Caterpillar Engine Removable Blankets

- Caterpillar Model 3054C Down Outlet (same as Perkins 1104C-44T) (P/N: FAB-EBS-CAT-104Z)
- Caterpillar Model 3054C Forward Outlet (same as Perkins 1104C-44T) (P/N: FAB-EBS-CAT-108Z)
- Caterpillar Model 3054T: 56-76Kw (P/N: FAB-EBS-CAT-0PKT65-04Z0)
- Caterpillar Model 3056 (P/N: FAB-EBS-CAT-0PKT62-0417)
- Caterpillar Model 3056E (P/N: FAB-EBS-CAT-064Z)
- Caterpillar Model 3066 (P/N: FAB-EBS-CAT-110-04Z)
- Caterpillar Model 3116 - 3126 T/TA (P/N: FAB-EBS-CAT-124Z)
- Caterpillar Model 3208T - DITA 205-275 Kw (P/N: FAB-EBS-CAT-147Z)
- Caterpillar Model 3304 Centre (P/N: FAB-EBS-CAT-156 ZC)
- Caterpillar Model 3304 Rear (P/N: FAB-EBS-CAT-160 RZ)
- Caterpillar Model 3306 Centre (P/N: FAB-EBS-CAT-18 6Z)
- Caterpillar Model 3306 Gas (P/N: FAB-EBS-CAT-216 GZ)
- Caterpillar Model 3406 Round Flange (P/N: FAB-EBS-CAT-229Z)
- Caterpillar Model 3408 Gas (P/N: FAB-EBS-CAT-2346Z)
- Caterpillar Model 3408 Standard (P/N: FAB-EBS-CAT-2337Z)
- Caterpillar Model 3412 Gas (P/N: FAB-EBS-CAT-2396Z)
- Caterpillar Model 3412T Dual Standard (P/N: FAB-EBS-CAT-253Z)
- Caterpillar Model 3412T Single (P/N: FAB-EBS-CAT-2368Z)
- Caterpillar Model 3412 Quad (P/N: FAB-EBS-CAT-3469Z)
- Caterpillar Model 343T (P/N: FAB-EBS-CAT-405Z)
- Caterpillar Model 3456T (P/N: FAB-EBS-CAT-3483Z)
- Caterpillar Model 3508 Top Mounted Turbos (P/N: FAB-EBS-CAT-3528Z)
- Caterpillar Model 3512 Dual Turbo (P/N: FAB-EBS-CAT-3618Z)
- Caterpillar Model 3516 B 2250 Kw (P/N: FAB-EBS-CAT-3779Z)
- Caterpillar Model 3516 Gas (P/N: FAB-EBS-CAT-3791Z)
- Caterpillar Model 3520C Gas (P/N: FAB-EBS-CAT-3798-12Z)
- Caterpillar Model 3612 (P/N: FAB-EBS-CAT-3806Z)
- Caterpillar Model 3616PG Gen Arrange (P/N: FAB-EBS-CAT-3906Z)
- Caterpillar Model 379T (P/N: FAB-EBS-CAT-524Z)
- Caterpillar Model 398T/399T (P/N: FAB-EBS-CAT-544Z)
- Caterpillar Model C-12 (P/N: FAB-EBS-CAT-575Z)
- Caterpillar Model C-13 Two Stage (P/N: FAB-EBS-CAT-588Z)
- Caterpillar Model C-15 (P/N: FAB-EBS-CAT-596Z)
- Caterpillar Model C-18 ACERT (P/N: FAB-EBS-CAT-608Z)
- Caterpillar Model C-27 w/Charge Air Piping (P/N: FAB-EBS-CAT-621-12Z)
- Caterpillar Model C-32 / C-27 (P/N: FAB-EBS-CAT-618-12Z)
- Caterpillar Model C-32 Charge Air Piping (P/N: FAB-EBS-CAT-620-12Z)
- Caterpillar Model C-4.4 (P/N: FAB-EBS-CAT-642Z)
- Caterpillar Model C-6.6 (P/N: FAB-EBS-CAT-665Z)
- Caterpillar Model C-9 No bosses (P/N: FAB-EBS-CAT-559Z)
- Caterpillar Model C-9 with bosses (P/N: FAB-EBS-CAT-554Z)
- Caterpillar Model D353T (P/N: FAB-EBS-CAT-515Z)
- Caterpillar Model D334 (P/N: FAB-EBS-CAT-3964Z)

## Cummins Engine Removable Blankets

• Cummins Model 4BT/4BTA 3.9	(P/N: FAB-EBS-CU-110-04Z)
• Cummins Model 4CT-3.9	(P/N: FAB-EBS-CU-115-05Z)
• Cummins Model 6 BT-8.3G ISC260	(P/N: FAB-EBS-CU-123-04Z)
• Cummins Model 6 CT/CTA-8.3G	(P/N: FAB-EBS-CU-126-04Z)
• Cummins Model 6 AT 3.4	(P/N: FAB-EBS-CU-120-06Z)
• Cummins Model 6BT 5.9	(P/N: FAB-EBS-CU-122-04Z)
• Cummins Model 6BTA	(P/N: FAB-EBS-CU-123-14Z)
• Cummins Model Case 6TAA-8304	(P/N: FAB-EBS-CU-222-09Z)
• Cummins Model GTA 28	(P/N: FAB-EBS-CU-201-04Z)
• Cummins Model GTA14-G1	(P/N: FAB-EBS-CU-128-G04Z)
• Cummins Model GTA 855	(P/N: FAB-EBS-CU-280-04Z)
• Cummins Model ISL 330 / 400	(P/N: FAB-EBS-CU-221-08Z)
• Cummins Model ISX600	(P/N: FAB-EBS-CU-201-04Z)
• Cummins Model KT / KTA 38G1	(P/N: FAB-EBS-CU-160-5Z)
• Cummins Model KTA 1150 / KT19	(P/N: FAB-EBS-CU-151-04Z)
• Cummins Model KTA 19	(P/N: FAB-EBS-CU-151-04Z)
• Cummins Model KTA 50 G1.2.3	(P/N: FAB-EBS-CU-170-05Z)
• Cummins Model KTTA 50 G2 (K2000E)	(P/N: FAB-EBS-CU-172-06Z)
• Cummins Model KTTA 50 G3	(P/N: FAB-EBS-CU-173-05Z)
• Cummins Model KTTA 19 G2	(P/N: FAB-EBS-CU-155-05)
• Cummins Model KTTA 38	(P/N: FAB-EBS-CU-162-06Z)
• Cummins Model L10 (M11, N14) Centre Mount	(P/N: FAB-EBS-CU-128-04Z)
• Cummins Model NT / NTA 855-G1/2	(P/N: FAB-EBS-CU-130-04Z)
• Cummins Model NTT / NTTA 855-G2	(P/N: FAB-EBS-CU-132-07Z)
• Cummins Model NT / NTA 855-G3-4	(P/N: FAB-EBS-CU-131-04Z)
• Cummins Model QSB 6.7	(P/N: FAB-EBS-CU-174-08Z)
• Cummins Model QSB7 (DSGAA)	(P/N: FAB-EBS-CU-174-116Z)
• Cummins Model QSC 8.3	(P/N: FAB-EBS-CU-174-18Z)
• Cummins Model QSK-19	(P/N: FAB-EBS-CU-180-04Z)
• Cummins Model QSK50 G4 (DQGAB)	(P/N: FAB-EBS-CU-186-05Z)
• Cummins Model QSB7 (DSGAA)	(P/N: FAB-EBS-CU-174-116Z)
• Cummins Model QSC 8.3	(P/N: FAB-EBS-CU-174-18Z)
• Cummins Model QSK-19	(P/N: FAB-EBS-CU-180-04Z)
• Cummins Model QSK50 G4 (DQGAB)	(P/N: FAB-EBS-CU-186-05Z)
• Cummins Model QSL9	(P/N: FAB-EBS-CU-191-14Z)
• Cummins Model QSL9-G5 (ISL250)	(P/N: FAB-EBS-CU-191-08Z)
• Cummins Model QSM11	(P/N: FAB-EBS-CU-128-14Z)
• Cummins Model QST-30G Quantum	(P/N: FAB-EBS-CU-175-06Z)
• Cummins Model QSX15-G8	(P/N: FAB-EBS-CU-192-06Z)
• Cummins Model VTA-28	(P/N: FAB-EBS-CU-140-04Z)
• Cummins Model VTA-28-G5	(P/N: FAB-EBS-CU-145-04Z)

## Daewoo Engine Removeable Insulation Blankets

• Daewoo Engine Model Excav Solar 130LC-V DB5AT	(P/N: FAB-EBS-DAE-12-5Z)
• Daewoo Engine Model D2840LE	(P/N: FAB-EBS-DAE-40-8Z)
• Daewoo Engine Model DB33A	(P/N: FAB-EBS-DAE-10-5Z)
• Daewoo Engine Model D1146T	(P/N: FAB-EBS-DAE-35-5Z)
• Daewoo Engine Model P126TI	(P/N: FAB-EBS-DAE-20-6Z)
• Daewoo Engine Model P158LE	(P/N: FAB-EBS-DAE-25-8Z)
• Daewoo Engine Model P180LE	(P/N: FAB-EBS-DAE-27-8Z)
• Daewoo Engine Model P222LE	(P/N: FAB-EBS-DAE-30-8Z)
• Daewoo Engine Model P086TI	(P/N: FAB-EBS-DAE-15-5Z)

### Daimler Chrysler Engine Removeable Insulation Blankets

- Mercedes Engine Model OM444LA (P/N: FAB-EBS-DC-444-09Z)
- Mercedes Engine Model OM904 (P/N: FAB-EBS-DC-904-05Z)
- Mercedes Engine Model OM906LA (P/N: FAB-EBS-DC-906-05Z)

### Detroit Diesel Engine Removeable Insulation Blankets

- Detroit Diesel Engine Model 471T 1043-8K32 (P/N: FAB-EBS-DD-0471-25Z)
- Detroit Diesel Engine Model 12V149T (P/N: FAB-EBS-DD-1249-11Z)
- Detroit Diesel Engine Model 12V2000 (P/N: FAB-EBS-DD-2012-06Z)
- Detroit Diesel Engine Model 12V4000 (P/N: FAB-EBS-DD-4012-10Z)
- Detroit Diesel Engine Model 12V71T 7123-7400 (P/N: FAB-EBS-DD-1271-14Z)
- Detroit Diesel Engine Model 12V92T (P/N: FAB-EBS-DD-1292-10Z)
- Detroit Diesel Engine Model 16V149T (P/N: FAB-EBS-DD-1649-10Z)
- Detroit Diesel Engine Model 16V2000 (P/N: FAB-EBS-DD-2016-06Z)
- Detroit Diesel Engine Model 16V4000 (P/N: FAB-EBS-DD-4016-10Z)
- Detroit Diesel Engine Model 16V4000 ADEC (P/N: FAB-EBS-DD-4016-29Z)
- Detroit Diesel Engine Model 16V92 / 71T (P/N: FAB-EBS-DD-1692-11Z)
- Detroit Diesel Engine Model 18V2000 (P/N: FAB-EBS-DD-2018-08Z)
- Detroit Diesel Engine Model 20V149TIB (P/N: FAB-EBS-DD-2049-14Z)
- Detroit Diesel Engine Model 20V4000 (P/N: FAB-EBS-DD-4020-10Z)
- Detroit Diesel Engine Model Detroit 353T (P/N: FAB-EBS-DD-0353-03Z)
- Detroit Diesel Engine Model 471T 1043-7305 (P/N: FAB-EBS-DD-0471-14Z)
- Detroit Diesel Engine Model 4V53T (P/N: FAB-EBS-DD-0453-03Z)
- Detroit Diesel Engine Model 671T 1063-7305 / 8600 (P/N: FAB-EBS-DD-0671-04Z)
- Detroit Diesel Engine Model 671TA 1063-8600 High Mount (P/N: FAB-EBS-DD-0671-24Z)
- Detroit Diesel Engine Model 6V71 (P/N: FAB-EBS-DD-0671-15Z)
- Detroit Diesel Engine Model 6V92 / 71M 7062-3600 (P/N: FAB-EBS-DD-0692-M08Z)
- Detroit Diesel Engine Model 6V92T 8063-7400 / 7B27 (P/N: FAB-EBS-DD-0692T-10Z)
- Detroit Diesel Engine Model 6V92TA 8063-7K32 (P/N: FAB-EBS-DD-0692-28Z)
- Detroit Diesel Engine Model 8.2T (P/N: FAB-EBS-DD-08200-04Z)
- Detroit Diesel Engine Model 8V2000 (P/N: FAB-EBS-DD-2008-06Z)
- Detroit Diesel Engine Model 8V4000 (P/N: FAB-EBS-DD-4008-10Z)
- Detroit Diesel Engine Model 8V71T Marine 7082-3300 (P/N: FAB-EBS-DD-0871-08MZ)
- Detroit Diesel Engine Model 8V71T 7082-7300 (P/N: FAB-EBS-DD-0892-10Z)
- Detroit Diesel Engine Model 8V92T 8083-7300 (P/N: FAB-EBS-DD-0892TT-10Z)
- Detroit Diesel Engine Model Series 40 DT466 (P/N: FAB-EBS-DD-40S-04Z)
- Detroit Diesel Engine Model Series 50 (P/N: FAB-EBS-DD-50S-04Z)
- Detroit Diesel Engine Model Series 60 (P/N: FAB-EBS-DD-60S-04HZ)

### Deutz Diesel Engine Removeable Insulation Blankets

- Deutz Engine Model BF12L-413FW (P/N: FAB-EBS-DEU-413-193Z)
- Deutz Engine Model BF3L-2011 (P/N: FAB-EBS-DEU-101-074Z)
- Deutz Engine Model BF4L-2011 (P/N: FAB-EBS-DEU-101-084Z)
- Deutz Engine Model BF4M-1011F (P/N: FAB-EBS-DEU-101-14Z)
- Deutz Engine Model BF4M-1012C (P/N: FAB-EBS-DEU-101-2004Z)
- Deutz Engine Model BF4M-1012E (P/N: FAB-EBS-DEU-101-204Z)
- Deutz Engine Model BF4M-1012EC (P/N: FAB-EBS-DEU-101-209Z)
- Deutz Engine Model BF4M-1013C (P/N: FAB-EBS-DEU-101-23Z)
- Deutz Engine Model BF4M-1013E (P/N: FAB-EBS-DEU-101-248Z)
- Deutz Engine Model BF4M-1013EC (P/N: FAB-EBS-DEU-101-261Z)
- Deutz Engine Model BF4M-1013FC (P/N: FAB-EBS-DEU-101-268Z)
- Deutz Engine Model BF4M-1011EC (P/N: FAB-EBS-DEU-101-19Z)
- Deutz Engine Model BF4M-2011 (P/N: FAB-EBS-DEU-101-2694Z)
- Deutz Engine Model BF4M-2012C (P/N: FAB-EBS-DEU-101-2704Z)
- Deutz Engine Model BF6M-2012C (P/N: FAB-EBS-DEU-101-74Z)

- Deutz Engine Model BF6L 913 (P/N: FAB-EBS-DEU-912-76Z)
- Deutz Engine Model BF6M-1013C (P/N: FAB-EBS-DEU-101-278Z)
- Deutz Engine Model BF6M-1013CP (P/N: FAB-EBS-DEU-101-31Z)
- Deutz Engine Model BF6M-1013E (P/N: FAB-EBS-DEU-101-44Z)
- Deutz Engine Model BF6M-1013EC (P/N: FAB-EBS-DEU-101-49Z)
- Deutz Engine Model BF6M-1013ECP (P/N: FAB-EBS-DEU-101-54Z)
- Deutz Engine Model BF6M-1013F / FC (P/N: FAB-EBS-DEU-101-64Z)
- Deutz Engine Model BF8M-1015C / CP (P/N: FAB-EBS-DEU-101-89Z)
- Deutz Engine Model F10L-413FW End Mount (P/N: FAB-EBS-DEU-413-178Z)
- Deutz Engine Model F12L-413 F / FW (P/N: FAB-EBS-DEU-413-183Z)
- Deutz Engine Model F6L-413-FW (P/N: FAB-EBS-DEU-413-153Z)
- Deutz Engine Model F8L-413-FW Center Mount (P/N: FAB-EBS-DEU-413-168Z)
- Deutz Engine Model TBD 616 12V (P/N: FAB-EBS-DEU-616-59Z)
- Deutz Engine Model TBD 616 8V (P/N: FAB-EBS-DEU-616-39Z)
- Deutz Engine Model TCD-2012L06 (P/N: FAB-EBS-DEU-750-08Z)
- Deutz Engine Model TCD2012L04-2V (P/N: FAB-EBS-DEU-201-24Z)
- Deutz Engine Model TCD2012L04-2V DCR (P/N: FAB-EBS-DEU-201-34Z)
- Deutz Engine Model TCD-2013L06 (P/N: FAB-EBS-DEU-753-08Z)
- Deutz Engine Model TCD2013L06-2V (P/N: FAB-EBS-DEU-201-54Z)

**EMD Electro-Motive Diesel Engine Removeable Insulation Blankets**

- EMD Engine Model 08V Blower 1 inch (P/N: FAB-EBS-EM-B08-1-8Z)
- EMD Engine Model 08V Blower with shield (P/N: FAB-EBS-EM-B08-S-8Z)
- EMD Engine Model 12V Turbo (P/N: FAB-EBS-EM-T12-1-12Z)
- EMD Engine Model 12V Blower 1 inch (P/N: FAB-EBS-EM-B12-1-8Z)
- EMD Engine Model 12V Blower with shield (P/N: FAB-EBS-EM-B12-S-8Z)
- EMD Engine Model 16V Blower 1 inch (P/N: FAB-EBS-EM-B16-1-8Z)
- EMD Engine Model 16V Blower with shield (P/N: FAB-EBS-EM-B16-S-8Z)
- EMD Engine Model 16V Turbo 1 inch (P/N: FAB-EBS-EM-T16-1-16Z)
- EMD Engine Model 20V Turbo 1 inch (P/N: FAB-EBS-EM-T20-1-20Z)
- EMD Engine Model 8V Turbo 1 inch (P/N: FAB-EBS-EM-T08-1-8Z)

**Ford Engine Removeable Insulation Blankets**

- Ford Engine Model 20Kw GGDB LRG-425I (P/N: FAB-EBS-FO-G4-04Z)
- Ford Engine Model 20RZ LSG 423 (P/N: FAB-EBS-FO-G4A-04Z)
- Ford Engine Model 30RZ LSG 649 (P/N: FAB-EBS-FO-G6-05Z)
- Ford Engine Model 35 / 45 Kw GGFB/C CSG649 (P/N: FAB-EBS-FO-G06-05Z)
- Ford Engine Model 45RZ LSG 649 (P/N: FAB-EBS-FO-KG6-05Z)
- Ford Engine Model Ford 50/70RZ LSG 875 (P/N: FAB-EBS-FO-KG8-06Z)
- Ford Engine Model 60/65 Kw GGHB LSG 875 (P/N: FAB-EBS-FO-G08-08Z)
- Ford Engine Model 70/100KW LSG 875 Industrial (P/N: FAB-EBS-FO-GSG18-8Z)
- Ford Engine Model 75/100Kw GGHD LSG 875 (P/N: FAB-EBS-FO-G28-08Z)
- Ford Engine Model 80/100RZ LSG 875 (P/N: FAB-EBS-FO-KG8-18Z)
- Ford Engine Model 80Kw GGHC LSG 875 (P/N: FAB-EBS-FO-G18-08Z)
- Ford Engine Model 85Kw GGHG/HH WSG-1068 (P/N: FAB-EBS-FO-G33-14Z)
- Ford Engine Model BSD444T (P/N: FAB-EBS-FO-B-5Z)
- Ford Engine Model WSG-1068 Naturally Aspired (P/N: FAB-EBS-FO-G34-12Z)

**GM - General Motors Engine Removable Insulation Blankets**

- GM Engine Model Vortec 4.3L Gas (P/N: FAB-EBS-GM-4.3-05Z)
- GM Engine Model 4M31 (P/N: FAB-EBS-GM-HAT-004Z)
- GM Engine Model Vortec 5.7L Gas (P/N: FAB-EBS-GM-5.7-07Z)
- GM Engine Model Vortec 8.1L Gas (P/N: FAB-EBS-GM-8.1-07Z)



**Hercules Engine Removable Insulation Blankets**

- Hercules Engine Model D2300T (P/N: FAB-EBS-HER-D005Z)
- Hercules Engine Model D3300T (P/N: FAB-EBS-HER-D105Z)
- Hercules Engine Model D3400T (P/N: FAB-EBS-HER-D205Z)
- Hercules Engine Model D4800TAH (P/N: FAB-EBS-HER-D405Z)
- Hercules Engine Model G3400 Gas Ver2 (P/N: FAB-EBS-HER-G626Z)
- Hercules Engine Model G3400T Gas (P/N: FAB-EBS-HER-G609Z)
- Hercules Engine Model G4800 Gas (P/N: FAB-EBS-HER-G718Z)
- Hercules Engine Model G4800T Gas (P/N: FAB-EBS-HER-G708Z)
- Hercules Engine Model International V605 Gas (P/N: FAB-EBS-HER-V605-6Z)

**Isuzu Engine Removable Insulation Blankets**

- Isuzu Engine Model 4BG1 Mid Mount (TPV) (P/N: FAB-EBS-ISU-44-6Z)
- Isuzu Engine Model 4JG1T (P/N: FAB-EBS-ISU-924Z)
- Isuzu Engine Model 6BB1 (QD-130) (P/N: FAB-EBS-ISU-52Z)
- Isuzu Engine Model 6BD1 (QD-145) (P/N: FAB-EBS-ISU-60-3Z)
- Isuzu Engine Model 6BD1T (QD-145T) (P/N: FAB-EBS-ISU-64Z)
- Isuzu Engine Model 6RB1T (QD-250T) (P/N: FAB-EBS-ISU-84Z)
- Isuzu Engine Model 6SA1 (QD-170) (P/N: FAB-EBS-ISU-70-3Z)
- Isuzu Engine Model 6SA1T (QD-170T) (P/N: FAB-EBS-ISU-74Z)
- Isuzu Engine Model 4HK1XYGV-02 (P/N: FAB-EBS-ISU-47-64Z)

**Iveco Engine Removable Insulation Blankets**

- Iveco Engine Model 8041 (P/N: FAB-EBS-IV-23Z)
- Iveco Engine Model 8061T (P/N: FAB-EBS-IV-414Z)
- Iveco Engine Model 8061TS125 (P/N: FAB-EBS-IV-424Z)
- Iveco Engine Model 8141S121 (P/N: FAB-EBS-IV-443Z)
- Iveco Engine Model 8210S102 (P/N: FAB-EBS-IV-453Z)
- Iveco Engine Model 8281SR126 (P/N: FAB-EBS-IV-545Z)
- Iveco Engine Model 8361S110 (P/N: FAB-EBS-IV-525Z)
- Iveco Engine Model 8361SR115 (P/N: FAB-EBS-IV-534Z)
- Iveco Engine Model N67ENTX 68.00 (P/N: FAB-EBS-IV-309Z)
- Iveco Engine Model NEF N45MSSD (P/N: FAB-EBS-IV-305Z)
- Iveco Engine Model 8041-S121 (P/N: FAB-EBS-IV-33Z)
- Iveco Engine Model 8061-SRM06 (P/N: FAB-EBS-IV-408Z)

**John Deere Engine Removable Insulation Blankets**

- John Deere Engine Model 6125 CK Power Option (P/N: FAB-EBS-JD-834Z)
- John Deere Engine Model 3029TF150 (P/N: FAB-EBS-JD-165Z)
- John Deere Engine Model 3179T (P/N: FAB-EBS-JD-154Z)
- John Deere Engine Model 4024HF285 (P/N: FAB-EBS-JD-244Z)
- John Deere Engine Model 4024TF (P/N: FAB-EBS-JD-234Z)
- John Deere Engine Model 4045TF150/4039T (P/N: FAB-EBS-JD-304Z)
- John Deere Engine Model 4039T (P/N: FAB-EBS-JD-308Z)
- John Deere Engine Model 4045 HF285 (P/N: FAB-EBS-JD-474Z)
- John Deere Engine Model 4045 TFM Power Tech (P/N: FAB-EBS-JD-434Z)
- John Deere Engine Model 4045HF485 (P/N: FAB-EBS-JD-464Z)
- John Deere Engine Model 4045T (P/N: FAB-EBS-JD-404Z)
- John Deere Engine Model 4045TF 4.5L Power Tech (P/N: FAB-EBS-JD-42AZ)
- John Deere Engine Model 4045TPWT 120 (P/N: FAB-EBS-JD-446EZ)
- John Deere Engine Model 4239A (P/N: FAB-EBS-JD-324Z)
- John Deere Engine Model 5030HF285 (P/N: FAB-EBS-JD-489Z)
- John Deere Engine Model 5030TF270B 3L (P/N: FAB-EBS-JD-484Z)
- John Deere Engine Model 6059T (P/N: FAB-EBS-JD-514Z)
- John Deere Engine Model 6068HF (P/N: FAB-EBS-JD-624Z)
- John Deere Engine Model 6068 HF (P/N: FAB-EBS-JD-674Z)
- John Deere Engine Model 6068HF275 (P/N: FAB-EBS-JD-644Z)
- John Deere Engine Model 6068HF485 (P/N: FAB-EBS-JD-669Z)

- John Deere Engine Model 6068T Power Tech (P/N: FAB-EBS-JD-614Z)
- John Deere Engine Model 6068TF150/250 (P/N: FAB-EBS-JD-604Z)
- John Deere Engine Model 6076A/6619A (P/N: FAB-EBS-JD-7A04Z)
- John Deere Engine Model 6076H (P/N: FAB-EBS-JD-7H04Z)
- John Deere Engine Model 6076T (P/N: FAB-EBS-JD-7T04Z)
- John Deere Engine Model 6081 Powertech (P/N: FAB-EBS-JD-819Z)
- John Deere Engine Model 6081AF/HF (P/N: FAB-EBS-JD-804AFZ)
- John Deere Engine Model 6081AFM (P/N: FAB-EBS-JD-809-4Z)
- John Deere Engine Model 6081T/TF (P/N: FAB-EBS-JD-814TZ)
- John Deere Engine Model 6090HF485 (P/N: FAB-EBS-JD-886Z)
- John Deere Engine Model 6125HF/6105AF (P/N: FAB-EBS-JD-824Z)
- John Deere Engine Model 6135HF485 (P/N: FAB-EBS-JD-864Z)
- John Deere Engine Model 6359A (P/N: FAB-EBS-JD-504Z)
- John Deere Engine Model J620 (P/N: FAB-EBS-JD-620-18Z)

### Kubota Engine Removable Insulation Blankets

- Kubota Engine Model V1305 / V1505 (BG) Manifold 16616-12312 (P/N: FAB-EBS-KB-B4T-03)
- Kubota Engine Model V1505T (P/N: FAB-EBS-KB-B4T-11)
- Kubota Engine Model D1105-BG (P/N: FAB-EBS-KB-B2F-21)
- Kubota Engine Model V2003TBG (P/N: FAB-EBS-KB-B5-21)
- Kubota Engine Model V2203 (P/N: FAB-EBS-KB-B5-41)
- Kubota Engine Model V2203M3 / V2003 (P/N: FAB-EBS-KB-B5-42)
- Kubota Engine Model V2403-M-T (P/N: FAB-EBS-KB-B5-66)
- Kubota Engine Model V2403 Turbo w/ straight out adapter option (P/N: FAB-EBS-KB-B5-71)
- Kubota Engine Model V3300T (P/N: FAB-EBS-KB-B6-21)
- Kubota Engine Model V3800 (P/N: FAB-EBS-KB-B6-44Z)

### Lister Petter Engine Removable Insulation Blankets

- Lister Petter Engine Model CS4 (P/N: FAB-EBS-LP-CS-03Z)
- Lister Petter Engine Model LPW3 (P/N: FAB-EBS-LP-L3-03Z)
- Lister Petter Engine Model LPWT4 (P/N: FAB-EBS-LP-LT4-05Z)
- Lister Petter Engine Model TR/S 3 (P/N: FAB-EBS-LP-S3-05Z)
- Lister Petter Engine Model TS 2 (P/N: FAB-EBS-LP-S2-05Z)
- Lister Petter Engine Model LPW3 A113 (P/N: FAB-EBS-LP-L3-11Z)

### Lombardini Engine Removable Insulation Blankets

- Lombardini Engine Model 1204 (P/N: FAB-EBS-LOM-1204-8Z)
- Lombardini Engine Model LDW 1603 (P/N: FAB-EBS-LOM-1603-1)
- Lombardini Engine Model LDW 2004T (P/N: FAB-EBS-LOM-2004-1)

### Mercedes Engine Removable Insulation Blankets

- Mercedes Engine Model OM904 (P/N: FAB-EBS-MERC-904-05Z)
- Mercedes Engine Model OM906LA (P/N: FAB-EBS-MERC-906-05Z)

### Merlin Engine Removable Insulation Blankets

- Merlin Marine Turbocharger 6"W x 16.5"L (P/N: FAB-EBS-MM-E4)
- Merlin Marine Turbocharger 7"W x 16.52"L (P/N: FAB-EBS-MM-E4/7SP)
- Merlin Marine Turbocharger 6"W x 19.5"L (P/N: FAB-EBS-MM-E4B)
- Merlin Marine Turbocharger 6"W x 25"L (P/N: FAB-EBS-MM-E6/9)
- Merlin Marine Turbocharger 9"W x 29"L (P/N: FAB-EBS-MM-E7)
- Merlin Marine Turbocharger 8"W x 24"L (P/N: FAB-EBS-MM-E8)

**Mitsubishi Engine Removable Insulation Blankets**

- Mitsubishi Engine Model 4D31T (P/N: FAB-EBS-MIT-4D31T-04Z)
- Mitsubishi Engine Model 4D34T (P/N: FAB-EBS-MIT-4D34T-12)
- Mitsubishi Engine Model 6D14 (P/N: FAB-EBS-MIT-6D14-03Z)
- Mitsubishi Engine Model 6D14D (P/N: FAB-EBS-MIT-6D14D-04Z)
- Mitsubishi Engine Model 6D14T (P/N: FAB-EBS-MIT-6D14T-04Z)
- Mitsubishi Engine Model 6D16T (P/N: FAB-EBS-MIT-6D16T-04Z)
- Mitsubishi Engine Model 6D16T/B No Bracket (P/N: FAB-EBS-MIT-6D16T-14Z)
- Mitsubishi Engine Model 6D22T/B (P/N: FAB-EBS-MIT-6D22T-04Z)
- Mitsubishi Engine Model 6D22TC (P/N: FAB-EBS-MIT-6D22TC-04Z)
- Mitsubishi Engine Model 6D24 12L (P/N: FAB-EBS-MIT-6D24-04Z)
- Mitsubishi Engine Model 6D31T (P/N: FAB-EBS-MIT-6D31T-04Z)
- Mitsubishi Engine Model 8DC9 16L (P/N: FAB-EBS-MIT-8DC9-06Z)
- Mitsubishi Engine Model S12A2 33.9L (P/N: FAB-EBS-MIT-S12-05Z)
- Mitsubishi Engine Model S12A2-TA 33.9L (P/N: FAB-EBS-MIT-S12-13Z)
- Mitsubishi Engine Model S12H PTA (P/N: FAB-EBS-MIT-S12-20Z)
- Mitsubishi Engine Model S12H TA 37.1L (P/N: FAB-EBS-MIT-S12-24Z)
- Mitsubishi Engine Model S12N (P/N: FAB-EBS-MIT-S12-35Z)
- Mitsubishi Engine Model S16N (P/N: FAB-EBS-MIT-S16-04Z)
- Mitsubishi Engine Model S16R (PTA) (P/N: FAB-EBS-MIT-S16-28Z)
- Mitsubishi Engine Model S4FT (P/N: FAB-EBS-MIT-S04FT-03Z)
- Mitsubishi Engine Model S4S DT (P/N: FAB-EBS-MIT-S04SDT-4Z)
- Mitsubishi Engine Model S6A3-TA 18.5L (P/N: FAB-EBS-MIT-S06-5Z)
- Mitsubishi Engine Model S6B3-TA 14.6L (P/N: FAB-EBS-MIT-S06-16Z)
- Mitsubishi Engine Model S6R2-TA 30L (P/N: FAB-EBS-MIT-S06R-14Z)
- Mitsubishi Engine Model S6R-TA (P/N: FAB-EBS-MIT-S06R-05Z)

**Nissan Engine Removable Insulation Blankets**

- Nissan Engine Model PE-6T (P/N: FAB-EBS-NIS-PE6T-8Z)

**Onan Cummins Engine Removable Insulation Blankets**

- Onan Cummins Engine Model 1000Kw(60Hz) DFJD KTA38-G4 (P/N: FAB-EBS-ONCU-160JD4-5Z)
- Onan Cummins Engine Model 110Kw DGEA 6CT8.3-G1 (P/N: FAB-EBS-ONCU-126EA-04Z)
- Onan Cummins Engine Model 1100Kw (60Hz) DFLB KTA50-G2 (P/N: FAB-EBS-ONCU-170LB-05Z)
- Onan Cummins Engine Model 1120Kw DFLE KTA50-G3 (P/N: FAB-EBS-ONCU-170LC-05Z)
- Onan Cummins Engine Model 1200Kw DFLD KTA50-G4 (P/N: FAB-EBS-ONCU-170LD-05Z)
- Onan Cummins Engine Model 1275Kw DFLE KTA50-G8/9 (P/N: FAB-EBS-ONCU-170LE-05Z)
- Onan Cummins Engine Model 1280Kw DFMB KTTA50-G2 (P/N: FAB-EBS-ONCU-172MB-06Z)
- Onan Cummins Engine Model 140Kw DGFA 6CTA8.3-G1 (P/N: FAB-EBS-ONCU-126FA-04Z)
- Onan Cummins Engine Model 150Kw DGFB 6CTA8.3-G1 (P/N: FAB-EBS-ONCU-126FB-04Z)
- Onan Cummins Engine Model 175 DFAA LTA10-G3 (P/N: FAB-EBS-ONCU-128AA3-04Z)
- Onan Cummins Engine Model 175 DGFC 6C (P/N: FAB-EBS-ONCU-126FC-04Z)
- Onan Cummins Engine Model 200Kw (60Hz) DFAA LTA10 G1 (P/N: FAB-EBS-ONCU-128AA1-04Z)
- Onan Cummins Engine Model 200Kw (60Hz) DQAA M11-G2 (P/N: FAB-EBS-ONCU-128AA-04Z)
- Onan Cummins Engine Model 220Kw DFAC LTA10-G3 (P/N: FAB-EBS-ONCU-128AC3-04Z)
- Onan Cummins Engine Model 230Kw (60Hz) DFAB LTA10-G1 (P/N: FAB-EBS-ONCU-128AB-04Z)
- Onan Cummins Engine Model 250Kw (60Hz) DFAC LTA10-G1 (P/N: FAB-EBS-ONCU-128AC1-04Z)
- Onan Cummins Engine Model 250Kw (60Hz) DQAB M11-G2 (P/N: FAB-EBS-ONCU-128AB2-04Z)
- Onan Cummins Engine Model 250Kw DFBF NT855-G6 (P/N: FAB-EBS-ONCU-13.1BF-04Z)
- Onan Cummins Engine Model 250Kw (60Hz) DGAC 6AT 3.4 (P/N: FAB-EBS-ONCU-1020AC-06Z)
- Onan Cummins Engine Model 275Kw DFCB NTA855-G2 (P/N: FAB-EBS-ONCU-130CB-04Z)
- Onan Cummins Engine Model 300Kw (60Hz) DQBA N14-G2 (P/N: FAB-EBS-ONCU-128BA-04Z)
- Onan Cummins Engine Model 330Kw DFEB KTA19-G2 (P/N: FAB-EBS-ONCU-150EB-04Z)
- Onan Cummins Engine Model 350Kw (60Hz) DFCC NTA855-G2 (P/N: FAB-EBS-ONCU-131CC2-04Z)
- Onan Cummins Engine Model 350Kw (60Hz) DFCC NTA855-G3 (P/N: FAB-EBS-ONCU-131CC3-04Z)
- Onan Cummins Engine Model 350Kw (60Hz) DQBB N14-G2 (P/N: FAB-EBS-ONCU-128BB-04Z)

- Onan Cummins Engine Model 352-440Kw DFEH/J/K QSX15-G2 (P/N: FAB-EBS-ONCU-192-06Z)
- Onan Cummins Engine Model 400Kw DGCA 4BT3.9-G4 (P/N: FAB-EBS-ONCU-110CA-04Z)
- Onan Cummins Engine Model 400kw (60Hz) DFCE NTA855-G6 (P/N: FAB-EBS-ONCU-131CE-04Z)
- Onan Cummins Engine Model 400kw DFEC KTA19-G2 (P/N: FAB-EBS-ONCU-151EC-04Z)
- Onan Cummins Engine Model 450Kw DFED KTA19-G2 (P/N: FAB-EBS-ONCU-151ED-04Z)
- Onan Cummins Engine Model 450Kw DFGA VTA 28 G5 (P/N: FAB-EBS-ONCU-145GA-05Z)
- Onan Cummins Engine Model 500Kw DGCB 4BT3.9-G4 (P/N: FAB-EBS-ONCU-110CB-04Z)
- Onan Cummins Engine Model 550Kw DFGB VTA 28 G5 (P/N: FAB-EBS-ONCU-145GB-05Z)
- Onan Cummins Engine Model 620Kw DFHA QST30-G1 (P/N: FAB-EBS-ONCU-175HA-05Z)
- Onan Cummins Engine Model 620Kw DFJC KTA38-G1 (P/N: FAB-EBS-ONCU-160JA-05Z)
- Onan Cummins Engine Model 650kW DGDA 6BT5.9-G1 (P/N: FAB-EBS-ONCU-122DA-04Z)
- Onan Cummins Engine Model 660Kw DFJB KTA38-G3 (P/N: FAB-EBS-ONCU-160JB-05Z)
- Onan Cummins Engine Model 700Kw DFHB QST30-G2 (P/N: FAB-EBS-ONCU-175HB-05Z)
- Onan Cummins Engine Model 800Kw DGCG 4BT3.9-G4 (P/N: FAB-EBS-ONCU-110CG-04Z)
- Onan Cummins Engine Model 800Kw DFJC KTA38-G3 (P/N: FAB-EBS-ONCU-160JC-5Z)
- Onan Cummins Engine Model 850Kw DGDB 6BT5.9-G2 (P/N: FAB-EBS-ONCU-122DB-04Z)
- Onan Cummins Engine Model 880Kw DFJD KTA38-G5 (P/N: FAB-EBS-ONCU-160JDS-5Z)
- Onan Cummins Engine Model 900Kw(60Hz) DFHC/DQFAD QST30-G3 (P/N: FAB-EBS-ONCU-175HC-05Z)
- Onan Cummins Engine Model Paxman 12YL (P/N: FAB-EBS-ONCU-PAX-12YL-30Z)
- Onan Cummins Engine Model Paxman 8YLCM with Shield Cover (P/N: FAB-EBS-ONCU-PAX-08YL-18Z)
- Onan Cummins Engine Model QSL G5 Engine Set DQDAA, AB, AC, DSHAB (P/N: FAB-EBS-ONCU-191-08Z)

**Perkins Engine Removable Insulation Blankets**

- Perkins Engine Model 1004-4T (P/N: FAB-EBS-PER-65-04Z)
- Perkins Engine Model 1006-TG (P/N: FAB-EBS-PER-62-041Z)
- Perkins Engine Model 1106C/1106D-(E)866TA (P/N: FAB-EBS-PER-81-08Z)
- Perkins Engine Model 1306-8TGA / 9TAG1 / DT466 (P/N: FAB-EBS-PER-D40S-04Z)
- Perkins Engine Model 2006-TG1 / 2A-C8TA (P/N: FAB-EBS-PER-64-14Z)
- Perkins Engine Model 4012 TAG2-12SE (P/N: FAB-EBS-PER-500-20Z)
- Perkins Engine Model 6.354 N (P/N: FAB-EBS-PER-60-04Z)
- Perkins Engine Model T4.236 (P/N: FAB-EBS-PER-42-04Z)
- Perkins Engine Model T4.236TP (P/N: FAB-EBS-PER-42-TPK04Z)
- Perkins Engine Model T6.3544 (P/N: FAB-EBS-PER-61-04Z)

**Pielstick Engine Removable Insulation Blankets**

- Pielstick Engine 18 PA6V-280 (P/N: FAB-EBS-PSK-18PA6V-20Z)

**Spectrum Engine Removable Insulation Blankets**

- Spectrum Engine Model DS200 671T 1063-7305 (P/N: FAB-EBS-SPD-0671-04Z)
- Spectrum Engine Model DS15/1600 16V149T (P/N: FAB-EBS-SPD-1649-10Z)
- Spectrum Engine Model DS150 Series 40 DT466 (P/N: FAB-EBS-SPD-40S-04Z)
- Spectrum Engine Model DS230/300 6V92T/TA (P/N: FAB-EBS-SPD-0692-10Z)
- Spectrum Engine Model DS350 8V92T 8083-7305 (P/N: FAB-EBS-SPD-0892T-10Z)
- Spectrum Engine Model DS400 8V92HO 8083-7416 (P/N: FAB-EBS-SPD-0892-H8Z)
- Spectrum Engine Model DS450 12V71TA 7123-7305 (P/N: FAB-EBS-SPD-1271-14Z)
- Spectrum Engine Model DS450 12V71TA 7123-7406 (P/N: FAB-EBS-SPD-1271C-05Z)
- Spectrum Engine Model DS50/60 T4.236 (P/N: FAB-EBS-SPD-PKT42-04Z)
- Spectrum Engine Model DS500/600 12V92TA (P/N: FAB-EBS-SPD-1292-10Z)
- Spectrum Engine Model DS750/800 16V92T (P/N: FAB-EBS-SPD-1692-11Z)
- Spectrum Engine Model DS80/100 1006-TG (P/N: FAB-EBS-SPD-PKT62-041Z)
- Spectrum Engine Model DS900/1200 12V149T (P/N: FAB-EBS-SPD-1249-11Z)
- Spectrum Engine Model DSE400 Series 60 Mid Mount (P/N: FAB-EBS-SPD-60S-14MZ)
- Spectrum Engine Model GS150 Series 50 Gas (P/N: FAB-EBS-SPD-50S-04Z)
- Spectrum Engine Model GSG 35 GM 4.3L Gas (P/N: FAB-EBS-SPD-M-4.3-13Z)
- Spectrum Engine Model GSG 50 GM Vortec 5.7L (P/N: FAB-EBS-SPD-M-5.7-07Z)
- Spectrum Engine Model GSG 60 GM Vortec 5.7L (P/N: FAB-EBS-SPD-M-5.7-17Z)

### **Stork Engine Removable Insulation Blankets**

- Stork Engine 240F 6FHD (P/N: FAB-EBS-STK-240-18Z)

### **Superior Engine Removable Insulation Blankets**

- Superior Engine Model 16SGTA (P/N: 16SGTA-18Z)

### **VM Motori Engine Removable Insulation Blankets**

- VM Motori Engine Model D703 LE (P/N: FAB-EBS-VMM-703LE-10Z)
- VM Motori Engine Model D703 LTE (P/N: FAB-EBS-VMM-703LTE-10Z)
- VM Motori Engine Model D704 LTE (P/N: FAB-EBS-VMM-704LTE-10Z)
- VM Motori Engine Model D706 LTE (P/N: FAB-EBS-VMM-706LTE-07Z)

### **Volvo Engine Removable Insulation Blankets**

- Volvo Engine Model TAD(TWD)740/741GE (P/N: FAB-EBS-VOL-0740-05Z)
- Volvo Engine Model T1D73AC (P/N: FAB-EBS-VOL-71-05Z)
- Volvo Engine Model TAD 1232GE (P/N: FAB-EBS-VOL-1232-06Z)
- Volvo Engine Model TAD 1240/1242GE (P/N: FAB-EBS-VOL-1242-06Z)
- Volvo Engine Model TAD1030/1031GE (P/N: FAB-EBS-VOL-1030-05Z)
- Volvo Engine Model TAD1630/31G/E (16.1A65) (P/N: FAB-EBS-VOL-1631-05Z)
- Volvo Engine Model TAD1640/1641GE (16.1B65) (P/N: FAB-EBS-VOL-1641-09Z)
- Volvo Engine Model TD73ED (P/N: FAB-EBS-VOL-73-05Z)
- Volvo Engine Model L220E (P/N: FAB-EBS-VOL-811-9Z)

### **Wartsila Engine Removable Insulation Blankets**

- Wartsila Engine Model UD 23 (P/N: FAB-EBS-WAR-23-09Z)
- Wartsila Engine Model UD 30 Y16 S4D/S6D (P/N: FAB-EBS-WAR-30-08Z)

### **Waukesha Engine Removable Insulation Blankets**

- Waukesha Engine Model 7042 GSI (P/N: FAB-EBS-WAU-1006Z)
- Waukesha Engine Model 12V-AT25 & 27 GL (P/N: FAB-EBS-WAU-2520Z)
- Waukesha Engine Model 7042 GLE (P/N: FAB-EBS-WAU-1029Z)
- Waukesha Engine Model 7042 GLE GNV Version (P/N: FAB-EBS-WAU-1050Z)
- Waukesha Engine Model F1197G (P/N: FAB-EBS-WAU-1106Z)
- Waukesha Engine Model L36GLD-12CYL (P/N: FAB-EBS-WAU-1209Z)
- Waukesha Engine Model VRG-330S 5.4L (P/N: FAB-EBS-WAU-1129Z)

### **Yanmar Engine Removable Insulation Blankets**

- Yanmar Engine Model 4TNE88 (P/N: FAB-EBS-YAN-4TN-12Z)
- Yanmar Engine Model 4TNV106T-XTBL (P/N: FAB-EBS-YAN-4TV-21)
- Yanmar Engine Model 4TNV84T-GGA (P/N: FAB-EBS-YAN-4TV-14Z)





## Removable Engine Blanket Set for Gensets – UL2200 1200°F / 648°C

### Diesel, Gasoline/Petrol and Natural Gas Piston and Gas Turbine Engines

Standard engine insulation blanket sets for the following engine makes and models are available (The Part Number is the ordering code for the complete set for that engine.)

#### Caterpillar Genset Removable Blankets

- CAT 3304 Genset (P/N: FAB-GBS-CAT-3304A3-08Z)

#### Generac Genset Removeable Insulation Blankets

- Generac Genset Model Mazda 3L Turbo, Diesel, 30Kw (P/N: FAB-GBS-GEN-030-3-A15Z)
- Generac Genset Model Hino 4L, Diesel, 30Kw (P/N: FAB-GBS-GEN-030-4.0-6Z)
- Generac Genset Model 3L-4 CYL I/L, Diesel, 35Kw (P/N: FAB-GBS-GEN-035-3.0-04Z)
- Generac Genset Model Mazda 3L, Diesel, 35Kw (P/N: FAB-GBS-GEN-035-3-B15Z)
- Generac Genset Model GM 4.3L, Gas, 35Kw (P/N: FAB-GBS-GEN-035-4.3-A03Z)
- Generac Genset Model GM 5.7L, Nat Gas, 35Kw (P/N: FAB-GBS-GEN-035-5.7-A5Z)
- Generac Genset Model GM 5.7L, Nat Gas, 40K (P/N: FAB-GBS-GEN-040-5.7-B5Z)
- Generac Genset Model GM 4.3L, Gas, 50Kw (P/N: FAB-GBS-GEN-050-4.3-A13Z)
- Generac Genset Model Hino 4L Turbo, 50Kw aftercooler (P/N: FAB-GBS-GEN-050-4-A26Z)
- Generac Genset Model 4T/A, Diesel, 50Kw (P/N: FAB-GBS-GEN-050-4-B24Z)
- Generac Genset Model GM 5.7L, Nat Gas, 50Kw (P/N: FAB-GBS-GEN-050-5.7-C5Z)
- Generac Genset Model GM 4.3L Gas, 60Kw Engine Blanket Set (P/N: FAB-GBS-GEN-060-4.3-A19)
- Generac Genset Model 4T/A Diesel, 60Kw Engine Blanket Set (P/N: FAB-GBS-GEN-060-4-C24Z)
- Generac Genset Model GM 5.7 Nat Gas, 60Kw (P/N: FAB-GBS-GEN-060-5.7-D5Z)
- Generac Genset Model Ford 5L Diesel, 60Kw (P/N: FAB-GBS-GEN-060-5-A06Z)
- Generac Genset Model GM 4.3L Gas, 75Kw (P/N: FAB-GBS-GEN-075-4.3-B19Z)
- Generac Genset Model Hino 4L Diesel with aftercooler, 75Kw (P/N: FAB-GBS-GEN-075-4-C26Z)
- Generac Genset Model 4T/A Diesel, 75Kw (P/N: FAB-GBS-GEN-075-4-D24Z)
- Generac Genset Model CSG 649 5L Diesel, 80Kw Ford Turbo (P/N: FAB-GBS-GEN-080-5-B05Z)
- Generac Genset Model CSG 649 5L Diesel, 100Kw Ford Turbo (P/N: FAB-GBS-GEN-100-5-C05Z)
- Generac Genset Model GM 7.4TA/GD Gas, 100Kw (P/N: FAB-GBS-GEN-100-7.4-113Z)
- Generac Genset Model GSG 649 5L Diesel, Ford Turbo, 125Kw (P/N: FAB-GBS-GEN-125-5-D08Z)
- Generac Genset Model 7.5L Diesel, 130Kw (P/N: FAB-GBS-GEN-130-7.5-A08Z)
- Generac Genset Model 13.3T/A Gas, 150Kw (P/N: FAB-GBS-GEN-150-13.3-A4Z)
- Generac Genset Model GM 7.4TA/GD Gas, 150Kw (P/N: FAB-GBS-GEN-150-7.4-113Z)
- Generac Genset Model 7.5L Diesel, 150Kw (P/N: FAB-GBS-GEN-150-7.5-B08Z)
- Generac Genset Model 7.5L Diesel, 155Kw (P/N: FAB-GBS-GEN-155-7.5-C08Z)
- Generac Genset Model 13.3T/A, Gas, 175Kw (P/N: FAB-GBS-GEN-175-13.3-B4Z)
- Generac Genset Model TAC 6D24TS Diesel, 180Kw (P/N: FAB-GBS-GEN-180-12-A04Z)
- Generac Genset Model SD180/200 Mitsubishi 7.5 DMTA, 180Kw/200Kw (P/N: FAB-GBS-GEN-180-7.5-A08Z)
- Generac Genset Model 7.5L Diesel 180Kw (P/N: FAB-GBS-GEN-180-7.5-D08Z)
- Generac Genset Model TAC 6D24TS Diesel 200Kw (P/N: FAB-GBS-GEN-200-12-B04Z)
- Generac Genset Model 13.3T/A Gas 200Kw (P/N: FAB-GBS-GEN-200-13.3-C4Z)
- Generac Genset Model TAC 6D24TS 12L Diesel, 230Kw (P/N: FAB-GBS-GEN-230-12-C04Z)
- Generac Genset Model 13.3T/A Gas, 230Kw (P/N: FAB-GBS-GEN-230-13.3-D4Z)
- Generac Genset Model TAC 6D24TS 12L Diesel, 250Kw (P/N: FAB-GBS-GEN-250-12-D04Z)
- Generac Genset Model 13.3T/A Gas 250Kw (P/N: FAB-GBS-GEN-250-13.3-E4Z)
- Generac Genset Model 13.3L Diesel 275Kw (P/N: FAB-GBS-GEN-275-13.3-F4Z)
- Generac Genset Model 13.3T/A Gas 275Kw (P/N: FAB-GBS-GEN-275-13.3-G4Z)
- Generac Genset Model 13.3L Diesel 300Kw (P/N: FAB-GBS-GEN-300-13.3-H4Z)
- Generac Genset Model 13L Diesel 350Kw (P/N: FAB-GBS-GEN-350-13-04Z)
- Generac Genset Model 6D24 12L Diesel 300Kw (P/N: FAB-GBS-GEN-MIT6D24-04Z)
- Generac Genset Model 8V 8DC9 16L Diesel 400Kw (P/N: FAB-GBS-GEN-MIT8DC9-06Z)
- Generac Genset Model S6B3-TA 14.6L Gas 400Kw (P/N: FAB-GBS-GEN-MITS06-16Z)

- Generac Genset Model S6A3-TA 18.5L Gas 500Kw (P/N: FAB-GBS-GEN-MITS06-5Z)
- Generac Genset Model S6R-TA 24.5L Gas 625Kw (P/N: FAB-GBS-GEN-MITS06R-5Z)
- Generac Genset Model S6R2-TA Gas 750Kw (P/N: FAB-GBS-GEN-MITS0R-14Z)
- Generac Genset Model S12A2 33.9L Gas 800Kw (P/N: FAB-GBS-GEN-MITS12-05Z)
- Generac Genset Model S12A2-TA 33.9L Gas 800Kw (P/N: FAB-GBS-GEN-MITS12-13Z)
- Generac Genset Model S12H TA 37.1L Gas 1020Kw (P/N: FAB-GBS-GEN-MITS12-24Z)
- Generac Genset Model S12A2-TA 33.9L Gas 1130Kw (P/N: FAB-GBS-GEN-MITS12-A13Z)

### Kohler Genset Removeable Insulation Blankets

- Kohler Genset Model 200ROZD 671T 1063-7305 (P/N: FAB-GBS-KOH-0671-04Z)
- Kohler Genset Model 230/300ROZD 6V92/71T 8063-7305 (P/N: FAB-GBS-KOH-0692-10Z)
- Kohler Genset Model 350ROZD 8V71T 8083-7305 (P/N: FAB-GBS-KOH-0892-10Z)
- Kohler Genset Model 400ROZD 8V92HO 8083-7416 (P/N: FAB-GBS-KOH-0892-H8Z)
- Kohler Genset Model 350ROZD 8V92T 8083-7405 (P/N: FAB-GBS-KOH-0892T-10Z)
- Kohler Genset Model 900-1200ROZD 12V-149TI (P/N: FAB-GBS-KOH-1249-11Z)
- Kohler Genset Model 450ROZD 12V71T 7123-7406H (P/N: FAB-GBS-KOH-1271C-05Z)
- Kohler Genset Model 5/600ROZD 12V92T 8123-7416 (P/N: FAB-GBS-KOH-1292-10Z)
- Kohler Genset Model 1500ROZD 16V-149TIB (P/N: FAB-GBS-KOH-1649-10Z)
- Kohler Genset Model 750/800ROZD 16V92/71T 8163-7405 (P/N: FAB-GBS-KOH-1692-11Z)
- Kohler Genset Model 2000ROZD 20V149TI (P/N: FAB-GBS-KOH-2049-14Z)
- Kohler Genset Model 1000ROZD 24V71T (P/N: FAB-GBS-KOH-2471-24CZ)
- Kohler Genset Model REOZP 200, 40S 8.7L (P/N: FAB-GBS-KOH-40S-04Z)
- Kohler Genset Model REOZD (RZD) 135/350, 60S 12.7L (P/N: FAB-GBS-KOH-60S-14MZ)
- Kohler Genset Model REOZD 135/350, 60S 12.7L WG (P/N: FAB-GBS-KOH-60S-19MZ)
- Kohler Genset Model REOZD 400, 60S 14L (P/N: FAB-GBS-KOH-60S-38Z)
- Kohler Genset Model ROZK 40, BF4M-1011F (P/N: FAB-GBS-KOH-EU-101-14Z)
- Kohler Genset Model ROZK 50, BF4M-1012E (P/N: FAB-GBS-KOH-EU-101-204Z)
- Kohler Genset Model ROZK 60, BF4M-1012EC (P/N: FAB-GBS-KOH-EU-101-209Z)
- Kohler Genset Model ROZK 70, BF4M-1013E (P/N: FAB-GBS-KOH-EU-101-248Z)
- Kohler Genset Model ROZK 80/90, BF4M-1013EC (P/N: FAB-GBS-KOH-EU-101-261Z)
- Kohler Genset Model ROZK 100, BF4M-1013FC (P/N: FAB-GBS-KOH-EU-268Z)
- Kohler Genset Model ROZK 115, BF6M-1013E (P/N: FAB-GBS-KOH-EU-101-44Z)
- Kohler Genset Model ROZK 135/150, BF6M-1013EC (P/N: FAB-GBS-KOH-EU-101-49Z)
- Kohler Genset Model ROZK 170, BF6M-1013FC (P/N: FAB-GBS-KOH-EU-101-64Z)
- Kohler Genset Model REOZD-4 450, 8V2000 (P/N: FAB-GBS-KOH-2008-06Z)
- Kohler Genset Model ROZD-4 5-600, 12V2000 (P/N: FAB-GBS-KOH-2012-06Z)
- Kohler Genset Model REOZDB 650, 12V2000 Mid Mount (P/N: FAB-GBS-KOH-2012-18Z)
- Kohler Genset Model ROZD-4 750-1000, 16V2000 (P/N: FAB-GBS-KOH-2016-06Z)
- Kohler Genset Model REOZDB 900, 16V2000 Mid Mount (P/N: FAB-GBS-KOH-28Z)
- Kohler Genset Model ROZD-4 1250/1500, 12V4000 (P/N: FAB-GBS-KOH-4012-10Z)
- Kohler Genset Model ROZD-4 1750/2000, 16V4000 (P/N: FAB-GBS-KOH-4016-10Z)
- Kohler Genset Model 20RZ CSG 423 (P/N: FAB-GBS-KOH-G404Z)
- Kohler Genset Model 30RZ CSG 649 (P/N: FAB-GBS-KOH-G6-05Z)
- Kohler Genset Model 35RZ CSG 649 (P/N: FAB-GBS-KOH-G6-12Z)
- Kohler Genset Model 45RZ CSG 649 (P/N: FAB-GBS-KOH-G6-05Z)
- Kohler Genset Model 50/70RZ LSG 875 (P/N: FAB-GBS-KOH-G8-06Z)
- Kohler Genset Model 80/100RZ LSG 875 (P/N: FAB-GBS-KOH-G8-18Z)
- Kohler Genset Model RZG 30/45, 4.3L (P/N: FAB-GBS-KOH-GM-4.3-07Z)
- Kohler Genset Model RZG 50/60, 5.7L Gas (P/N: FAB-GBS-KOH-GM-5.7-07Z)
- Kohler Genset Model RZG 80/100, Vortec 8.1L (P/N: FAB-GBS-KOH-GM-8.1-10Z)
- Kohler Genset Model RZG 125, Vortec 8.1L (P/N: FAB-GBS-KOH-GM-8.1T-10Z)
- Kohler Genset Model REOZJB 20, 3029T (P/N: FAB-GBS-KOH-J154Z)
- Kohler Genset Model REOZJB 20/40, 3029TF150 (P/N: FAB-GBS-KOH-J165Z)
- Kohler Genset Model ROZJ 50/60, 4039T (P/N: FAB-GBS-KOH-J303Z)
- Kohler Genset Model REOZJB 50/60, 4045TF150 (P/N: FAB-GBS-KOH-J3044Z)
- Kohler Genset Model 50 REOZJ 4045TF (P/N: FAB-GBS-KOH-J306Z)
- Kohler Genset Model 60 REOZJ 4045TF (P/N: FAB-GBS-KOH-J310Z)
- Kohler Genset Model REOZJB 80, 4045TF250 (P/N: FAB-GBS-KOH-J428Z)
- Kohler Genset Model ROZJ 80/100, 6059T (P/N: FAB-GBS-KOH-J514Z)

- Kohler Genset Model REOZJB 100/150, 6068TF250 (P/N: FAB-GBS-KOH-J604Z)
- Kohler Genset Model REOZJB 150, 6068HF150 (P/N: FAB-GBS-KOH-J624Z)
- Kohler Genset Model 150/180ROZJ 6076A (P/N: FAB-GBS-KOH-J7A04Z)
- Kohler Genset Model 125ROZJ 6076T (P/N: FAB-GBS-KOH-J7T04Z)
- Kohler Genset Model REOZJB 180/230, 6081AF001 (P/N: FAB-GBS-KOH-J804AFZ)
- Kohler Genset Model REOZJC 50, 4024TF285 (P/N: FAB-GBS-KOH-J805Z)
- Kohler Genset Model REOZJC 180, 6068TF250 (P/N: FAB-GBS-KOH-J809Z)
- Kohler Genset Model ROZJ 135, 6081TF (P/N: FAB-GBS-KOH-J814TZ)
- Kohler Genset Model ROEZM 600, S6R-PTA (D600, 24.5A60) (P/N: FAB-GBS-KOH-MITS06R-5Z)
- Kohler Genset Model REOZM 750, S12A2-TA 33.9L (P/N: FAB-GBS-KOH-MITS12-20Z)
- Kohler Genset Model REOZM 900/1000, S12H-PTA (P/N: FAB-GBS-KOH-MITS12-20Z)
- Kohler Genset Model ROZP 50/60, T4.236 (P/N: FAB-GBS-KOH-PKT42-04Z)
- Kohler Genset Model REOZV 200/230, TAD740/741GE (P/N: FAB-GBS-KOH-HV-0740-05Z)
- Kohler Genset Model REOZV 230/250, TAD1030/31GE (P/N: FAB-GBS-KOH-HV-1030-05Z)
- Kohler Genset Model REOZV/C 275/400, TAD1242GE (D350 12.1A65)  
(P/N: FAB-GBS-KOH-HV-1242-06Z)
- Kohler Genset Model REOZV 500, TAD1631GE (16.1A65) (P/N: FAB-GBS-KOH-HV-1631-05Z)
- Kohler Genset Model REOZVB 500, TAD1641GE (16.1B65) (P/N: FAB-GBS-KOH-HV-1641-09Z)

### Kubota Genset Removeable Insulation Blankets

- Kubota Genset Model D1105T (P/N: FAB-GBS-KB-2F-44Z)
- Kubota Genset Model Z482, 2 cylinder (P/N: FAB-GBS-KB-8-04Z)

### Olympian Genset Removeable Insulation Blankets

- Olympian Genset Model D100P1/S 100 Kw, Perkins 1006TG2A (P/N: FAB-GBS-OLP-KT62-C041Z)
- Olympian Genset Model D125P1 125 Kw, Perkins 1006TAG (P/N: FAB-GBS-OLP-KT62-F041Z)
- Olympian Genset Model D150P1 150 Kw, Perkins 1006TAG1 (P/N: FAB-GBS-OLP-KT62-G041Z)
- Olympian Genset Model D200P1 200 Kw, Perkins 1306-9TAG1 (P/N: FAB-GBS-OLP-SD40-A04Z)
- Olympian Genset Model D20L1/S 20 Kw, Lister LPWT4 (P/N: FAB-GBS-OLP-LP-LT4-05Z)
- Olympian Genset Model D230P1 230 Kw, Perkins 1306-9TAG3 (P/N: FAB-GBS-OLP-SD40-B04Z)
- Olympian Genset Model D50P1/S 50 Kw, Perkins T4.236 (P/N: FAB-GBS-OLP-PKT42-B04Z)
- Olympian Genset Model D60P1/S 60 Kw, Perkins T4.236 (P/N: FAB-GBS-OLP-PKT42-C04Z)
- Olympian Genset Model D75P1 75 Kw, Perkins 1004TG (P/N: FAB-GBS-OLP-PKT6.5-04Z)
- Olympian Genset Model D75P1 75 Kw, Perkins 1006TG1A (P/N: FAB-GBS-OLP-PKT62-A041Z)
- Olympian Genset Model D90P1/S 90 Kw, Perkins 1006TG1A (P/N: FAB-GBS-OLP-PKT62-B041Z))
- Olympian Genset Model G100F1 100 Kw, Ford LSG875 (P/N: FAB-GBS-OLP-FGSG18-E8Z)
- Olympian Genset Model G20F1/S 20 Kw, Ford LRG425 (P/N: FAB-GBS-OLP-FG04-A04Z)
- Olympian Genset Model G25F1/S 25 Kw, Ford LRG425 (P/N: FAB-GBS-OLP-FG04-B04Z)
- Olympian Genset Model G30F1/S 30 Kw, Ford CSG649 (P/N: FAB-GBS-OLP-FG06-A05Z)
- Olympian Genset Model G35F1S 35 Kw, Ford CSG649 (P/N: FAB-GBS-OLP-FG06-B05Z)
- Olympian Genset Model G40 F1 40 Kw, Ford CSG649 (P/N: FAB-GBS-OLP-FG06-C05Z)
- Olympian Genset Model G45F1/S 45 Kw, Ford CSG649 (P/N: FAB-GBS-OLP-FG06-D05Z)
- Olympian Genset Model G60F1 60 Kw, Ford LSG875 (P/N: FAB-GBS-OLP-FGSG18-B8Z)
- Olympian Genset Model G75F1/S 75 Kw, Ford LSG875 (P/N: FAB-GBS-OLP-FGSG18-C8Z)

**Don't See Your Genset? We can still build a set of blankets based on sketches, measurements, photos, drawings, measurements.....**



## Removable Blanket and Insulation Systems for Selective Catalytic Reduction units (SCR)

1200°F / 648°C

### Diesel, Gasoline/Petrol and Natural Gas Piston and Gas Turbine Engines

Standard engine insulation blanket sets for the following engine makes and models are available (The Part Number is the ordering code for the complete set for that engine.)

- Steuler SCR model L8X7/4 (P/N: FAB-SCR-STE-005-30Z)
- Steuler SCR model L8X7/4 (P/N: FAB-SCR-STE-006-30Z)
- Steuler SCR model L8X7/4 (P/N: FAB-SCR-STE-007-30Z)
- Steuler SCR model L7X8/4 (P/N: FAB-SCR-STE-008-30Z)
- Steuler SCR model L8X6/4 (P/N: FAB-SCR-STE-010-30Z)
- Steuler SCR model L10X10/4 +2 (P/N: FAB-SCR-STE-011-30Z)
- Steuler SCR model L6X6 (P/N: FAB-SCR-STE-013-30Z)
- Steuler SCR model L4X6/4+2 (P/N: FAB-SCR-STE-015-30Z)
- Steuler SCR model L8X6/4 (P/N: FAB-SCR-STE-016-30Z)
- Steuler SCR model L8X6/4 (P/N: FAB-SCR-STE-017-30Z)
- Steuler SCR model L10X10/4 +2 (P/N: FAB-SCR-STE-018-30Z)
- Steuler SCR model L10X10/4 +2 (P/N: FAB-SCR-STE-019-30Z)
- Steuler SCR model L8X8/4+2 (P/N: FAB-SCR-STE-020-30Z)
- Steuler SCR model L10X8/4+2 (P/N: FAB-SCR-STE-022-30Z)
- Steuler SCR model L4X6/4+2 (P/N: FAB-SCR-STE-024-30Z)
- Steuler SCR model L6X6/4+3 (P/N: FAB-SCR-STE-025-30Z)
- CAT SCR model GX0049 (P/N: FAB-SCR-CAT-SCR001)
- Cummins SCR model Sinox 2000 8X8 (P/N: FAB-SCR-ARG10-001-50Z)
- Siemens SCR model Sinox 12X12 (P/N: FAB-SCR-ARG10-003-50Z)
- Argillon SCR model Sinox 6X6 (P/N: FAB-SCR-ARG10-005-50Z)



## Removable Blanket and Insulation Systems for Gas and Diesel Agricultural, Construction & Mining Vehicles

### Diesel, Gasoline/Petrol and Natural Gas Piston and Gas Turbine Engines

Standard engine insulation blanket sets for the following engine makes and models are available (The Part Number is the ordering code for the complete set for that engine.)

#### Atlas Copco Vehicle Engine Removable Insulation Blankets

- Atlas Copco Drill - Boomer 281 Engine Blanket Set (P/N: FAB-VEH-ATCO-BMR281A1-10Z)
- Atlas Copco Drill - Boomer 282 Engine Blanket Set (P/N: FAB-VEH-ATCO-BMR282A3-10Z)
- Atlas Copco Drill - Boomer H-104 Engine Blanket Set (P/N: FAB-VEH-ATCO-BMR-H104A3-9Z)
- Atlas Copco Loader EJC 130 Engine Blanket Set (P/N: FAB-VEH-ATCO-EJC130A3-18Z)
- Atlas Copco Loader 210 Engine Blanket Set (P/N: FAB-VEH-ATCO-EJC210B2-08Z)
- Atlas Copco Loader EJC 210 Engine Blanket Set (P/N: FAB-VEH-ATCO-EJC30SXA3-10Z)
- Atlas Copco Loader - JD T 426 Engine Blanket Set (P/N: FAB-VEH-ATCO-EJC426A2-08Z)
- Atlas Copco Loader - EJC 430 Engine Blanket Set (P/N: FAB-VEH-ATCO-EJC430A3-08Z)
- Atlas Copco Loader - EJC 515 Engine Blanket Set (P/N: FAB-VEH-ATCO-EJC515A3-11Z)
- Atlas Copco Drill - M2 D18 Engine Blanket Set (P/N: FAB-VEH-ATCO-WABM2D18A3-09Z)
- Atlas Copco Bolter Engine Blanket Set (P/N: FAB-VEH-ATCO-WABTMDA3-19Z)

#### BTI Vehicle Engine Removable Insulation Blankets

- BTI 906 Scaler Engine Blanket Set (P/N: FAB-VEH-BTI-BRK-906-18Z)
- BTI DS25-3 Scaler Engine Blanket Set (P/N: FAB-VEH-BTI-BRK-DS25-12Z)
- BTI TM12X Scaler Engine Blanket Set (P/N: FAB-VEH-BTI-BRK-TM12X-8Z)
- BTI TM15XH Scaler Engine Blanket Set (P/N: FAB-VEH-BTI-BRK-TM15XH-18Z)
- BTI Carrier Engine Blanket Set (P/N: FAB-VEH-BTI-001-8Z)

#### CASE Vehicle Engine Removable Insulation Blankets

- CASE A45 Grader Engine Blanket Set (P/N: FAB-VEH-CASE-A45A3-10Z)
- CASE 1460 Combine Engine Blanket Set (P/N: FAB-VEH-CASE-1460A-11Z)
- CASE 1680 Combine Engine Blanket Set (P/N: FAB-VEH-CASE-1680A-11Z)
- CASE 1688 Combine Engine Blanket Set (P/N: FAB-VEH-CASE-1688A-11Z)
- CASE 2188 Combine Engine Blanket Set (P/N: FAB-VEH-CASE-2188A-11Z)
- CASE 2388 Combine Engine Blanket Set (P/N: FAB-VEH-CASE-2388A-11Z)
- CASE 2388 Combine Engine Blanket Set (P/N: FAB-VEH-CASE-2388B-11Z)

#### Caterpillar CAT Vehicle Engine Removable Insulation Blankets

- Caterpillar CAT 301.8C Excavator Engine Blanket Set (P/N: FAB-VEH-CAT-301.8C-02Z)
- Caterpillar CAT M120 Grader Engine Blanket Set (P/N: FAB-VEH-CAT-0120A1-4Z)
- Caterpillar CAT 930G Loader Engine Blanket Set (P/N: FAB-VEH-CAT-0930A3-8Z)
- Caterpillar CAT D5C Dozer Engine Blanket Set (P/N: FAB-VEH-CAT-0D5CA3-8Z)
- Caterpillar CAT 321C Excavator Engine Blanket Set (P/N: FAB-VEH-CAT-CATE090-8Z)
- Caterpillar CAT 918F Loader Engine Blanket Set (P/N: FAB-VEH-CAT-CATE-124Z)
- Caterpillar CAT 924F Loader Engine Blanket Set (P/N: FAB-VEH-CAT-CATE-134Z)
- Caterpillar CAT 980C Loader Engine Blanket Set (P/N: FAB-VEH-CAT-CATE168Z)
- Caterpillar CAT 236 Loader Engine Blanket Set (P/N: FAB-VEH-CAT-CATE214Z)
- Caterpillar CAT 908 Engine Blanket Set (P/N: FAB-VEH-CAT-908Z)
- Caterpillar CAT 420EIT Engine Blanket Set (P/N: FAB-VEH-CAT-420Z)
- Caterpillar CAT 3406 Engine Blanket Set (P/N: FAB-VEH-CAT-219-5Z)



**Cubex Vehicle Engine Removable Insulation Blankets**

- Cubex Orion Drill Engine Blanket Set (P/N: FAB-VEH-CUB-10A3-001Z)
- Cubex Pegasus Drill Engine Blanket Set (P/N: FAB-VEH-CUB-10A3-002Z)
- Cubex 6200D Drill Engine Blanket Set (P/N: FAB-VEH-CUB-6200D-A3-8Z)
- Cubex Aries Drill Engine Blanket Set (P/N: FAB-VEH-CUB-ARIE-A3-9Z)

**Dodge Vehicle Engine Removable Insulation Blankets**

- Dodge Truck 6CT5.9TR Engine Blanket Set (P/N: FAB-VEH-DOD-121-04Z)

**Getman Vehicle Engine Removable Insulation Blankets**

- Getman Truck Engine Blanket Set (P/N: FAB-VEH-GET-001A3-18Z)

**Jarvis Clarke Vehicle Engine Removable Insulation Blankets**

- Jarvis Clarke Scissor Lift 41SL Engine Blanket Set (P/N: FAB-VEH-JAC-41SL-D3-9Z)
- Jarvis Clarke Scissor Lift 43SL Engine Blanket Set (P/N: FAB-VEH-JAC-43SL-A3-9Z)
- Jarvis Clarke Scoop JS350 Engine Blanket Set (P/N: FAB-VEH-JAC-JS350A2-9Z)

**John Deere Vehicle Engine Removable Insulation Blankets**

- John Deere Combine 9500/9550 Engine Blanket Set (P/N: FAB-VEH-JD-C9550-9Z)
- John Deere Combine 9600/9610 Engine Blanket Set (P/N: FAB-VEH-JD-C9550-9Z)
- John Deere Combine 9650/9750 Engine Blanket Set (P/N: FAB-VEH-JD-C9750-9Z)
- John Deere Excavator 160 Engine Blanket Set (P/N: FAB-VEH-JD-E554Z)
- John Deere Excavator 200LC Engine Blanket Set (P/N: FAB-VEH-JD-E604Z)
- John Deere Timberjack 608 Engine Blanket Set (P/N: FAB-VEH-JD-E629Z)
- John Deere Timberjack 850 Engine Blanket Set (P/N: FAB-VEH-JD-E649Z)
- John Deere Skid Steer 328/332 Engine Blanket Set (P/N: FAB-VEH-JD-E669Z)
- John Deere Tractor 5425 Engine Blanket Set (P/N: FAB-VEH-JD-5425A3-18Z)
- John Deere Grader 670D Engine Blanket Set (P/N: FAB-VEH-JD-670DA3-11Z)

**Komatsu Vehicle Engine Removable Insulation Blankets**

- Komatsu Truck model EJ2068 Engine Blanket Set (P/N: FAB-VEH-KOM-EJ2068)
- Komatsu Truck model EJ2069 Engine Blanket Set (P/N: FAB-VEH-KOM-EJ2069)
- Komatsu Truck model EJ2070 Engine Blanket Set (P/N: FAB-VEH-KOM-EJ2070)
- Komatsu Truck model EJ2071 Engine Blanket Set (P/N: FAB-VEH-KOM-EJ2071)
- Komatsu Truck model EJ3257 Engine Blanket Set (P/N: FAB-VEH-KOM-EJ3257)
- Komatsu Truck model EJ3258 Engine Blanket Set (P/N: FAB-VEH-KOM-EJ3258)
- Komatsu Truck model EJ3259 Engine Blanket Set (P/N: FAB-VEH-KOM-EJ3259)
- Komatsu Truck model EJ3260 Engine Blanket Set (P/N: FAB-VEH-KOM-EJ3260)
- Komatsu Truck model EJ3261 Engine Blanket Set (P/N: FAB-VEH-KOM-EJ3261)
- Komatsu Truck model EJ3262 Engine Blanket Set (P/N: FAB-VEH-KOM-EJ3262)
- Komatsu Truck model EJ3309 Engine Blanket Set (P/N: FAB-VEH-KOM-EJ3309)
- Komatsu Truck model EJ3310 Engine Blanket Set (P/N: FAB-VEH-KOM-EJ3310)
- Komatsu Truck model EJ3311 Engine Blanket Set (P/N: FAB-VEH-KOM-EJ3311)
- Komatsu Truck model EJ3314 Engine Blanket Set (P/N: FAB-VEH-KOM-EJ3314)
- Komatsu Truck model EJ3318 Engine Blanket Set (P/N: FAB-VEH-KOM-EJ3318)
- Komatsu Truck model EJ3338 Engine Blanket Set (P/N: FAB-VEH-KOM-EJ3338)
- Komatsu Truck model EJ3341 Engine Blanket Set (P/N: FAB-VEH-KOM-EJ3341)
- Komatsu Truck model EJ3342 Engine Blanket Set (P/N: FAB-VEH-KOM-EJ3342)
- Komatsu Truck model EJ3343 Engine Blanket Set (P/N: FAB-VEH-KOM-EJ3343)
- Komatsu Truck model EJ3397 Engine Blanket Set (P/N: FAB-VEH-KOM-EJ3397)
- Komatsu Truck model EJ3400 Engine Blanket Set (P/N: FAB-VEH-KOM-EJ3400)
- Komatsu Truck model EJ3401 Engine Blanket Set (P/N: FAB-VEH-KOM-EJ3401)
- Komatsu Truck model EJ3419 Engine Blanket Set (P/N: FAB-VEH-KOM-EJ3419)
- Komatsu Truck model EJ3422 Engine Blanket Set (P/N: FAB-VEH-KOM-EJ3422)
- Komatsu Truck model EJ3423 Engine Blanket Set (P/N: FAB-VEH-KOM-EJ3423)
- Komatsu Truck model EJ3424 Engine Blanket Set (P/N: FAB-VEH-KOM-EJ3424)
- Komatsu Truck model EJ3434 Engine Blanket Set (P/N: FAB-VEH-KOM-EJ3434)
- Komatsu Truck model EJ3437 Engine Blanket Set (P/N: FAB-VEH-KOM-EJ3437)
- Komatsu Truck model EJ3438 Engine Blanket Set (P/N: FAB-VEH-KOM-EJ3438)
- Komatsu Truck model EJ3439 Engine Blanket Set (P/N: FAB-VEH-KOM-EJ3439)

- Komatsu Truck model EJ3497 Engine Blanket Set (P/N: FAB-VEH-KOM-EJ3497)
- Komatsu Truck model EJ3502 Engine Blanket Set (P/N: FAB-VEH-KOM-EJ3502)
- Komatsu Truck model PB9713 Engine Blanket Set (P/N: FAB-VEH-KOM-PB9713)
- Komatsu Truck model PC228 Engine Blanket Set (P/N: FAB-VEH-KOM-PC228-18Z)

**MACK Vehicle Engine Removable Insulation Blankets**

- MACK Truck model MR688S Engine Blanket Set (P/N: FAB-VEH-MACK-1010)
- MACK Truck model MR688S Engine Blanket Set (P/N: FAB-VEH-MACK-1015)
- MACK Truck model MR688S Engine Blanket Set (P/N: FAB-VEH-MACK-1020)
- MACK Truck model MR688S Engine Blanket Set (P/N: FAB-VEH-MACK-1025)
- MACK Truck model MR688S Engine Blanket Set (P/N: FAB-VEH-MACK-1026)
- MACK Truck model MR688S Engine Blanket Set (P/N: FAB-VEH-MACK-1027)
- MACK Truck model MR688S Engine Blanket Set (P/N: FAB-VEH-MACK-1030)
- MACK Truck model MR688S Engine Blanket Set (P/N: FAB-VEH-MACK-1035)
- MACK Truck model MR688S Engine Blanket Set (P/N: FAB-VEH-MACK-1036)
- MACK Truck model MR688S Engine Blanket Set (P/N: FAB-VEH-MACK-1040)
- MACK Truck model MR688S Engine Blanket Set (P/N: FAB-VEH-MACK-1045)
- MACK Truck model MR688S Engine Blanket Set (P/N: FAB-VEH-MACK-1050)

**Maclean Vehicle Engine Removable Insulation Blankets**

- Maclean Bolter model 1013 Engine Blanket Set (P/N: FAB-VEH-MCL-1013A3-20Z)
- Maclean Bolter model 928 Engine Blanket Set (P/N: FAB-VEH-MCL-928AS-10Z)
- Maclean Bolter model 933 Engine Blanket Set (P/N: FAB-VEH-MCL-922A3-12Z)
- Maclean Carrier model 944 Engine Blanket Set (P/N: FAB-VEH-MCL-944A3-12Z)
- Maclean Boom model 966-011 Engine Blanket Set (P/N: FAB-VEH-MCL-966AS-10Z)
- Maclean Cherry Picker model 969 Engine Blanket Set (P/N: FAB-VEH-MCL-969AHD-9Z)
- Maclean Utility model 977 Engine Blanket Set (P/N: FAB-VEH-MCL-977AS-10Z)
- Maclean Utility model 993 Engine Blanket Set (P/N: FAB-VEH-MCL-993A3-10Z)
- Maclean Bolter model M40 Engine Blanket Set (P/N: FAB-VEH-MCL-M40A3-12Z)
- Maclean Personnel Carrier model PC3-003 Engine Blanket Set (P/N: FAB-VEH-MCL-PC3-A3-10Z)

**Marcotte Vehicle Engine Removable Insulation Blankets**

- Marcotte Boom Engine Blanket Set (P/N: FAB-VEH-MAR-14A3-10Z)
- Marcotte Fuel Truck Engine Blanket Set (P/N: FAB-VEH-MAR-F8LA3-10Z)
- Marcotte Cement Truck Engine Blanket Set (P/N: FAB-VEH-MAR-F8LC3-10Z)
- Marcotte Loader model Anfo Engine Blanket Set (P/N: FAB-VEH-MAR-C0555A3-9Z)
- Marcotte Carrier model M10 Engine Blanket Set (P/N: FAB-VEH-MAR-C0M10A3-08Z)
- Marcotte Carrier model M30 Engine Blanket Set (P/N: FAB-VEH-MAR-C0M30A3-16Z)
- Marcotte Carrier model M35 Engine Blanket Set (P/N: FAB-VEH-MAR-C0M35A3-16Z)
- Marcotte Carrier model M40 Engine Blanket Set (P/N: FAB-VEH-MAR-C0M40A3-9Z)
- Marcotte Scissor Lift Engine Blanket Set (P/N: FAB-VEH-MAR-C0SLIFTA3-12Z)
- Marcotte Powder Truck Engine Blanket Set (P/N: FAB-VEH-MAR-PDRA3-9Z)

**Miller Vehicle Engine Removable Insulation Blankets**

- Miller Bolter Engine Blanket Set (P/N: FAB-VEH-MIL-LBTR304A3-09Z)
- Miller Haulage Truck model DT1604 Engine Blanket Set (P/N: FAB-VEH-MIL-TDT1604BRA-8Z)
- Miller Haulage Truck model DT3004 Engine Blanket Set (P/N: FAB-VEH-MIL-TIDT3004A3-8Z)

**Mine Jack Vehicle Engine Removable Insulation Blankets**

- Mine Jack Carrier model M60A Engine Blanket Set (P/N: FAB-VEH-MJ-M60A-A1-9Z)

### **Mixmaster Vehicle Engine Removable Insulation Blankets**

- Mixmaster Truck Engine Blanket Set (P/N: FAB-VEH-MIX-RDH10-001-10Z)

### **MTI Vehicle Engine Removable Insulation Blankets**

- MTI Scoop model JCI 125 Engine Blanket Set (P/N: FAB-VEH-MTI-JCI125A3-8Z)
- MTI Drill model Tunnel Runner Engine Blanket Set (P/N: FAB-VEH-MTI-JUMC3-14Z)
- MTI Drill model Vein Runner Engine Blanket Set (P/N: FAB-VEH-MTI-JUMD2-14Z)
- MTI Scoop model LT-70 Engine Blanket Set (P/N: FAB-VEH-MTI-LT070A3-11Z)
- MTI Scoop model LT-270 Engine Blanket Set (P/N: FAB-VEH-MTI-LT270D2-8Z)
- MTI Loader model LT-350 Engine Blanket Set (P/N: FAB-VEH-MTI-LT350A3-18Z)
- MTI Loader model LT-650 Engine Blanket Set (P/N: FAB-VEH-MTI-LT650B2-10Z)
- MTI Stope Runner model SR 360Y Engine Blanket Set (P/N: FAB-VEH-MTI-SR360A3-10Z)
- MTI Loader model LT-1050 Engine Blanket Set (P/N: FAB-VEH-MTI-LT-1050A2-9Z)

### **New Holland Vehicle Engine Removable Insulation Blankets**

- New Holland Combine model TR97 Engine Blanket Set (P/N: FAB-VEH-NH-TR97A-9Z)

### **Norment Vehicle Engine Removable Insulation Blankets**

- Norment model 871 Engine Blanket Set (P/N: FAB-VEH-NOR-871A3-12Z)

### **Omega Vehicle Engine Removable Insulation Blankets**

- Omega model UG44T Engine Blanket Set (P/N: FAB-VEH-OM-UG44TA3-11Z)

### **REG Vehicle Engine Removable Insulation Blankets**

- REG Locomotive Engine Blanket Set (P/N: FAB-VEH-REG-001A3-8Z)

### **Robbins Rasiebore Vehicle Engine Removable Insulation Blankets**

- Robbins Rasiebore Truck Engine Blanket Set (P/N: FAB-VEH-ROB-001A3-18Z)

### **Tamrock Vehicle Engine Removable Insulation Blankets**

- Tamrock Rockbolt model 7 Engine Blanket Set (P/N: FAB-VEH-TAM-007A1-9Z)

### **Toro Vehicle Engine Removable Insulation Blankets**

- Toro Truck model 40D Engine Blanket Set (P/N: FAB-VEH-TOR-0040A-08Z)
- Toro Scoop model 210 Engine Blanket Set (P/N: FAB-VEH-TOR-0210A3-10Z)
- Toro Loader model 400 Engine Blanket Set (P/N: FAB-VEH-TOR-0400A3-9Z)
- Toro Loader model 430 Engine Blanket Set (P/N: FAB-VEH-TOR-0430A3-9Z)
- Toro Loader model 501 Engine Blanket Set (P/N: FAB-VEH-TOR-0501A3-9Z)
- Toro Loader model 650D Engine Blanket Set (P/N: FAB-VEH-TOR-0650A1-12Z)
- Toro Loader model 1400 Engine Blanket Set (P/N: FAB-VEH-TOR-1400ARA-8Z)

### **Volvo Vehicle Engine Removable Insulation Blankets**

- Volvo Loader model L220E Engine Blanket Set (P/N: FAB-VEH-VOL-220LEA3-09Z)

### **Wagner Vehicle Engine Removable Insulation Blankets**

- Wagner Truck model MT426 Engine Blanket Set (P/N: FAB-VEH-WAG-0426C3-18Z)
- Wagner Truck model MT444 Engine Blanket Set (P/N: FAB-VEH-WAG-0444B3-08Z)
- Wagner Truck model MT2000 Engine Blanket Set (P/N: FAB-VEH-WAG-MT2000A3-9Z)
- Wagner Truck model MT416 Engine Blanket Set (P/N: FAB-VEH-WAG-MT416A3-9Z)
- Wagner Truck model MT426 Engine Blanket Set (P/N: FAB-VEH-WAG-MT426B3-9Z)
- Wagner Truck model MT433 Engine Blanket Set (P/N: FAB-VEH-WAG-MT433A2-9Z)
- Wagner Truck model MT436 Engine Blanket Set (P/N: FAB-VEH-WAG-MT436A3-12Z)

- Wagner Truck model MT439 Engine Blanket Set (P/N: FAB-VEH-WAG-MT439A3-12Z)
- Wagner Truck model MT5010 Engine Blanket Set (P/N: FAB-VEH-WAG-MT5010A2-18Z)
- Wagner Scoop model ST1010 Engine Blanket Set (P/N: FAB-VEH-WAG-ST1010A3-09Z)
- Wagner Scoop model ST1020 Engine Blanket Set (P/N: FAB-VEH-WAG-ST1020A3-09Z)
- Wagner Scoop model ST1030 Engine Blanket Set (P/N: FAB-VEH-WAG-ST1030A3-11Z)
- Wagner Loader model ST14 Engine Blanket Set (P/N: FAB-VEH-WAG-ST14A3-8Z)
- Wagner Loader model ST1510 Engine Blanket Set (P/N: FAB-VEH-WAG-ST1510A1-8Z)
- Wagner Scoop model ST2G Engine Blanket Set (P/N: FAB-VEH-WAG-ST2GA3-8Z)
- Wagner Scoop model ST3.5 Engine Blanket Set (P/N: FAB-VEH-WAG-ST3.5A3-18Z)
- Wagner Scoop model ST6C Engine Blanket Set (P/N: FAB-VEH-WAG-ST6CA3-9Z)
- Wagner Scoop model ST7.5 Engine Blanket Set (P/N: FAB-VEH-WAG-ST7.5A3-8Z)
- Wagner Scoop model ST700 Engine Blanket Set (P/N: FAB-VEH-WAG-ST700A3-09Z)
- Wagner Scoop model ST8B Engine Blanket Set (P/N: FAB-VEH-WAG-ST8BB3-8Z)

**Wajax Vehicle Engine Removable Insulation Blankets**

- Wajax Backhoe model EX2500 Engine Blanket Set (P/N: FAB-VEH-WAJ-2500Z)
- Wajax Shovel model EX5500 Engine Blanket Set (P/N: FAB-VEH-WAJ-5500Z)

**Don't See Your Vehicle? We can still build a set of blankets based on sketches, measurements, photos, drawings, measurements.....**

**Quote Request Forms for Engine Component Insulation Blankets**

**General Overview & Dimensions**



**EXHAUST SYSTEM DRAWING**

A
B
C
D
E
F
G
H
i
J
K
L
M
N
O
P
Q
R
S
T
U
V
W
X
Y
Z

1. MAKE AND MODEL OF SILENCER? IS IT A SIDE INLET OR STRAIGHT THROUGH DESIGN?  
 2. IS THERE A DRAIN OR SPARK ARRESTOR ON THE SILENCER? LOCATE ON DRAWING.  
 3. LOCATE ALL HANGERS AND SUPPORTS ON DRAWING

PLEASE CIRCLE PIPE HANGER/SUPPORT BELOW

PLEASE CIRCLE SILENCER HANGER/SUPPORT BELOW

Notes: \_\_\_\_\_  
 \_\_\_\_\_  
 \_\_\_\_\_  
 \_\_\_\_\_  
 \_\_\_\_\_

Your Email Address: \_\_\_\_\_ Phone: \_\_\_\_\_  
 Name: \_\_\_\_\_



**Muffler / Silencer Dimensions Form for Insulation Blankets**

**REQUIRED SILENCER INFORMATION**

**Through Inlet/Outlet**

**ALL SILENCER VERSIONS**

A	∅	
B	Weld to weld length	
C	Inlet/outlet OD	
D	Outlet offset (0 if N/A)	

**THRU INLET/OUTLET VERSION ONLY**

E	Inlet offset (0 if N/A)	
F	Support 1 Offset (if applicable)	
G	Support 2 Offset (if applicable)	
H	Support Width	

**SIDE INLET VERSION ONLY**

I	Inlet offset	
J	Support 1 Offset (if applicable)	
K	Support 2 Offset (if applicable)	

**Side Inlet**

**Muffler / Silencer Support Type and Bracket Location Dimensions**

**TYPICAL SILENCER HANGER/SUPPORT DRAWING**

EXAMPLE 1
EXAMPLE 2
EXAMPLE 3
EXAMPLE 4

Please indicate the relevant support system.

**Example of dimensions required to locate brackets**

Through Inlet/Outlet

Side Inlet

A	
B	
C	
D	

## Flex, Flange and Elbow Dimensions for Insulation Blankets

### REQUIRED INFORMATION FOR FLEXES, FLANGES, AND ELBOWS

#### FLEX AND FLANGES

##### FLEXES

A	OD	
B	LENGTH	

##### FLANGES

C	OD	
D	Flange Width	

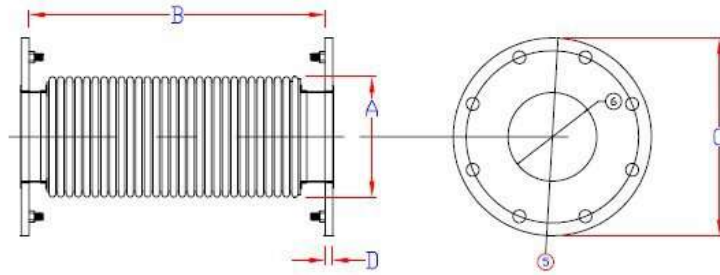

#### 90° ELBOWS

A	OD	
B	Radius Length	
C	Extension 1	
D	Extension 2	

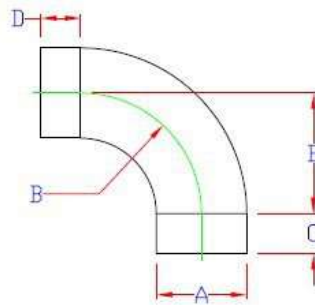

#### MISCILANEOUS ELBOWS

A	OD	
B	Angle (if known)	
C	Outer Arc Length	
D	Inner Arc Length	

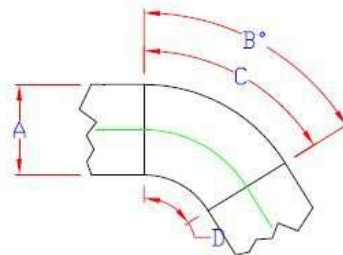

**Turbo Charger Dimension Form for Insulation Blankets**

**AB Technology Group**  
 info@abthermal.com  
 Fax 610-340-9054

**GENERIC TURBO DIMENSION SHEET.**

ENGINE MAKE: \_\_\_\_\_  
 ENGINE MODEL: \_\_\_\_\_

1	
2	
3	
4	
5	
6	
7	
8	
9	
10	
11	
12	
13	
14	
15	



## **Thermal, EMI/RFI & Abrasion Protection Materials**

*Fax Orders: 610-340-9054 Telephone Orders: 610-906-3549 [orders@abthermal.com](mailto:orders@abthermal.com)*

---



## Fire Protection Removable Blanket and Shield Insulation Systems for Mine Equipment Engine Exhaust Components: 1200°F / 648°C ExhaustGuard™ For Mufflers, Silencers, Turbo Chargers, Elbows, Flex Pipes, Straight Pipes and Flanges



- Provides fire protection from fluid leaks and burst fuel and oil lines from contacting hot engine exhaust components.
- Two versions: ExhaustGuard Mine and MineXT. Mine version has a stainless inner liner to help prevent fluids from soaking the insulation layer. MineXT provides a stainless mesh outer cover to protect the outer fabric layer from tears and punctures.
- Meets MIL-I-24222; USCG 164.009; ASTM E84; UL 2200.
- Suitable for gasoline & diesel reciprocating engines.
- Custom made to form fit components.
- Removable blanket sections are assembled with either locking wire or spring clips connecting the hook fasteners that are mounted on the blankets.
- Collar system helps to prevent liquids from entering section gaps.
- Provides OSHA compliant accidental contact burn protection for personnel.

**Removable Insulation Covers for  
Industrial / Marine Valves and Piping – Indoor and Outdoor  
Heat Loss / Heat Gain / Freeze Protection for Ball / Butterfly /  
Gate Valves / Piping and Heat Exchangers**



Custom fabricated removable insulation systems provide personnel protection, heat loss & heat gain protection, freeze protection. For heat loss and heat gain, energy savings payback is typically measured in months.

Various heat tapes with settable or fixed thermostat control are available for valve freeze protection covers. Outdoor covers feature hydrophobic insulation.

## Blow-Out / Spray Protection Shields for Valves & Pipe Flanges

Blow-Out & Spray Protection Shields protect personnel and equipment from high pressure spray from failed gaskets and seals.

Reduces risk of injury.

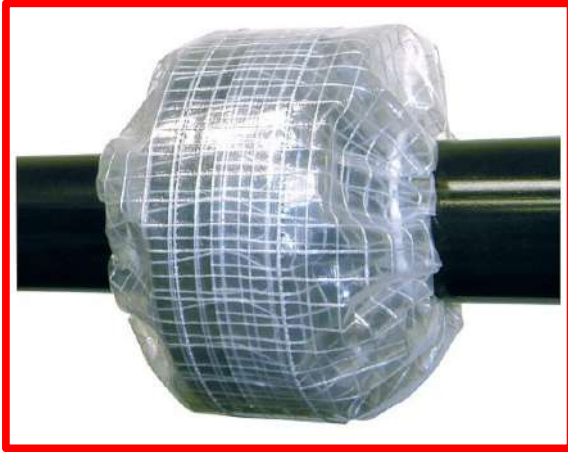

- Available in three versions:
  - 1) Ballistic Woven Nylon with polyurethane coating.
  - 2) High temperature ptfe coated fibreglass.
  - 3) Pure ptfe sheet.
- Pure ptfe sheet has greatest chemical compatibility range from ph 1 to 14. Temperature range -100°F to +550°F. FDA Approved. Translucent allows for easy visual inspection.
- Fiberglass coated with ptfe version for excellent chemical resistance.
- Nylon version meets EN982 ISO norm 833 & EN414 for hose blowout operator protection. Exceeds ISO 6945 abrasion standard and ISO 8031 conductivity standard.
- Easily installed and easily removed to allow for maintenance and inspection.
- Custom manufactured for any valve/flange size.
- Call for pricing.
- Part Number FAB-FSS-X-Y  
"X" is the ANSI Flange size  
"Y" is the material;  
N for Nylon  
PFG for PTFE coated fibreglass  
PP for Pure PTFE



## Steel and Metal Processing Plant Custom Fabrications

### Festoon Protection Jacket Covers



### Power Track Protection Jacket Systems



### Bellows for Protecting Lift Cylinders



**Heated Removable Insulation Covers for Gas Cylinders**  
**General Use and CSA Hazardous Area Approved (Class I, Division 1)**



- Improves process control and reduces wasted condensed gas.
- Increases pressure.
- CSA rated for Class I Div 1, Groups B, C and D.
- Fits most gas cylinders.
- Self regulating 150 watts of heating.
- 2 inch side insulation; 0.5" top insulation.
- 10 foot power lead.
- Particularly useful for Propane, Nitrogen, Oxygen, SF6, BCl3, WF6 and HF gases.

<b>ThermaCover™ Gas Cylinder Heaters – CSA Approved Hazardous Areas</b>			
<b>Part Number</b>	<b>Size inch / mm</b>	<b>Voltage</b>	<b>Price</b>
FAB-GCH-HCW-8480-X	8 x 48 / 203 x 1219	120 / 240	\$ 1848.34
FAB-GCH-HCW-951-X	9 x 51 / 229 x 1295	120 / 240	\$ 1878.00
FAB-GCH-HCW-1047-X	10 x 47 / 254 x 1194	120 / 240	\$ 1898.00
FAB-GCH-HCW-1543-X	15 x 43 / 381 x 1092	120 / 240	\$ 2070.00

For the X value, specify "120" for 120 volt or "240" for 220-240 volt operation

<b>ThermaCover™ Gas Cylinder Heaters – General Use Areas</b>			
<b>Part Number</b>	<b>Size inch / mm</b>	<b>Voltage</b>	<b>Price</b>
FAB-GCH-GCW-8480-X	8 x 48 / 203 x 1219	120 / 240	\$ 819.34
FAB-GCH-GCW-951-X	9 x 51 / 229 x 1295	120 / 240	\$ 901.00
FAB-GCH-GCW-1543-X	15 x 43 / 381 x 1092	120 / 240	\$ 1109.00

For the X value, specify "120" for 120 volt or "240" for 220-240 volt operation

Other sizes and designs available



## Heated Removable Insulation Covers and Heating Pads for Industrial Bulk Container Tote Tanks / Intermediate Bulk Containers



### Heated Cover

- Helps speed the flow of high viscosity fluids such as oils, lubes, foods.
- Provides freeze protection.
- Does not contaminate or scorch product.
- Separate heat zones allows heat adjustment when the level lowers.
- Fits any tote tank from 40" (1016mm) x 40" (1016mm) to 48" (1219mm) x 48" (1219mm)
- Three standard heights: 36" (914mm), 42" (1067mm), 48" (1220mm)
- Adjustable thermostat 50° to 160°F
- Hi temperature safety cutoff at 195°F (91°C) for each zone
- Silicone rubber fabric resists contamination. Insulation layer ¼" thick
- Meets NEC 427.23 for ground safety.
- Wattage: 120VAC; 1440 watts / 240VAC; 2880 watts
- Optional insulated top cover for increased thermal protection.

### Heating Pad

- Heating Pad Wattage: 120VAC 1600 watts / 240VAC 3240watts

ThermaCover™ Heated Insulation Covers & Heater Pads for Totes			
Part Number	Size inch / mm	Voltage	Price
FAB-TOTE-36-X	36" / 914mm height	120 / 240	\$ 1639.00
FAB-TOTE-42-X	42" / 1067mm height	120 / 240	\$ 1829.00
FAB-TOTE-48-X	48" / 1220mm height	120 / 240	\$ 1979.00
FAB-TOTE-COVER			\$ 235.00
FAB-TOTE-PAD-X	32" x 36" / 813mm x 914mm	120 / 240	\$ 1083.00

For the X value, specify "120" for 120 volt or "240" for 220-240 volt operation

**55 & 30 Gallon Drum Insulated Covers  
55 Gallon Drum Insulated Covers with Heaters**



- Helps speed the flow of high viscosity fluids such as oils, lubes, foods.
- Provides freeze protection.
- Does not contaminate or scorch product.
- Dual heat zone version.
- Adjustable thermostat 50 to 160F
- Wattage:  
55 gallon metal drums: 1600 watts  
55 gallon metal drums with dual zone: 3200 watts  
55 gallon poly drums: 770 watts
- Optional insulated top cover for increased thermal protection.
- High Temperature Silicone Rubber Coated Fiberglass Fabric with 1" thick fiberglass insulation.
- Designed for Indoor use.

ThermaCover™ Drum Insulated Covers		
Part Number	Size inch / mm	Price
FAB-DIN-55	55 gallon (208 litre)	\$ 452.68
FAB-DIN-30	30 gallon (114 litre)	\$ 412.34
FAB-DIN-TC55	Top Cover for 55 gallon drum	\$ 108.42

ThermaCover™ Drum Insulated Covers with Heaters			
Part Number	Size inch / mm	Voltage	Price
FAB-DIN-55MET-X	55 gallon / 1600 watt	120/240	\$ 979.00
FAB-DIN-55MET-DUAL	55 gallon / 3200 watt dual zone	240	\$ 1399.00
FAB-DIN-55POLY-X	770 watt	120/240	\$ 994.00

For the X value, specify "120" for 120 volt or "240" for 220-240 volt operation

**UltraFlex™ Silicone Rubber Pipe & Hose Heating Tape**  
**Fixed Thermostat Control**  
 Freeze protection and general process heating - 120 & 240 Volt



- Two temperature versions available: 70°F/21°C or 120°F/49°C.
- 6.0 watts/square inch
- Extremely flexible silicone rubber heater strip.
- Moisture and chemical resistant. IP66 rating.
- Safe for use on metal surfaces.
- Multi-strand resistance element for mechanical durability.
- Heater strip maximum exposure 450°F 232°C.
- 5 foot 1.8m power cord with 2 prong plug for 120VAC. Bare wire pigtail for 240VAC.
- Custom temperature setting and lengths available.

UltraFlex™ Pipe & Hose Heating Tapes - Fixed Thermostat				
Part Number	Size of heat tape width / length	Voltage	Watts	Price
FAB-SR-UFTRACE-0510-X-Y	0.50" / 10 ft	120 / 240	60	\$ 318.00
FAB-SR-UFTRACE-0520-X-Y	0.50" / 20 ft	120 / 240	120	\$ 378.00
FAB-SR-UFTRACE-0540-X-Y	0.50" / 40 ft	120 / 240	240	\$ 418.00
FAB-SR-UFTRACE-0550-X-Y	0.50" / 50 ft	120 / 240	300	\$ 438.00
FAB-SR-UFTRACE-0560-X-Y	0.50" / 60 ft	120 / 240	360	\$ 458.00
FAB-SR-UFTRACE-0575-X-Y	0.50" / 75 ft	120 / 240	450	\$ 478.00
FAB-SR-UFTRACE-0580-X-Y	0.50" / 80 ft	120 / 240	480	\$ 498.00
FAB-SR-UFTRACE-05100-X-Y	0.50" / 100 ft	120 / 240	600	\$ 570.00
FAB-SR-UFTRACE-05125-X-Y	0.50" / 125 ft	120 / 240	750	\$ 576.00

For the X value, specify "120" for 120 volt or "240" for 220-240 volt operation

For the Y value, specify "70" for 70°F setting or "120" for 120°F setting

**FreezeFlow™ Pipe & Hose Heating Tapes - Thermostat Controlled**  
Freeze protection and general process heating - 120 & 240 Volt



- Adjustable thermostat controlled heating.
- Adjustable to a maximum of 160°F / 71°C. 6.0 watts/square inch
- Extremely flexible silicone rubber heater strip.
- Moisture and chemical resistant. IP54 rating.
- Safe for use on metal surfaces.
- Multi-strand resistance element for mechanical durability.
- Heater strip maximum exposure 450°F 232°C.
- 6 foot 1.8m power cord with 2 prong plug for 120VAC. Bare wire pigtail for 240VAC.

FreezeFlow™ Pipe Heating Tapes - Thermostat Controlled				
Part Number	Size of heat tape width / length	Voltage	Watts	Price
FAB-SR-TRACE-102-X	1" / 2 ft	120 / 240	144	\$ 256.00
FAB-SR-TRACE-104-X	1" / 4 ft	120 / 240	288	\$ 270.00
FAB-SR-TRACE-106-X	1" / 6 ft	120 / 240	432	\$ 284.00
FAB-SR-TRACE-108-X	1" / 8 ft	120 / 240	576	\$ 298.00
FAB-SR-TRACE-110-X	1" / 10 ft	120 / 240	720	\$ 334.00
FAB-SR-TRACE-115-X	1" / 15 ft	120 / 240	1080	\$ 381.00
FAB-SR-TRACE-120-X	1" / 20 ft	120 / 240	1200	\$ 416.00
FAB-SR-TRACE-130-X	1" / 30 ft	120 / 240	1440	\$ 494.00
FAB-SR-TRACE-140-X	1" / 40 ft	120 / 240	1440	\$ 576.00
FAB-SR-TRACE-150-X	1" / 50 ft	120 / 240	1440	\$ 674.00

For the X value, specify "120" for 120 volt or "240" for 220-240 volt operation

## Thermal Insulated Equipment Covers 500°F / 260°C: Eco-Blanket™ For Lab Ovens, Process Equipment, Test Equipment, Control Equipment



Photo shows cross section of construction method.

- Helps keep heat in or out.
- Saves energy.
- Silicone rubber coated fabric on both sides resists contamination. Insulation layer can be ¼, 1/2 or 1" thick. Thicker available. PTFE coated fabric is also available
- Insulation is totally encased and prevented from movement by quilted sewing pattern.
- Other inner and outer fabric types available, such as PTFE coated, Aluminized PET Film coated.
- Variety of openings and access flaps available for exhaust gas, cooling flow, conduit, control panels, switches or valves.
- Can be sewn together to fit over or around equipment - or assembled in panels with snaps, zippers, straps, turnbuckles, hook and loop, etc.
- Silicone Fabric can be supplied in Industrial grade, or to meet MIL-I-24244, UL 214, NFPA 701, or NRC Guide 1.36 for flame, fire or smoke ratings.
- Silicone coated fabric available in standard weight of 17.5 oz/sq/yd or Heavy Duty 32 oz/sq/yd fabric.

For a quotation, please supply a sketch, dimensions, drawing or photo

Part Number will be FAB-ECSP-XXXX



**Robotic Covers – Thermal Heat Process Protective; Welding Splatter/Slag and Grinding Spark and Debris Protective; Food Processing and Handling FDA Approved Custom Fitted**



- Using a variety of outer fabrics, provides protection from heat, flame, weld splatter, slag, grinding spark and debris, fumes.
- FDA Approved materials for food processing and handling applications.
- Full rotational collars at strategic locations provides for full mobility.

Please Contact Us For Details

## Steam Trap Jackets – Easy Energy Savings



- Removeable to allow inspection.
- Energy savings – fast ROI.
- Pocket for asset tag.
- Suitable for Inverted Bucket, F&T (Float & Thermostatic), Orifice Traps, Float.
- Not suitable for Thermostatic (Balanced Pressure/Bimetallic), Thermodynamic.
- Custom sizes available – please supply dimensions, model number, photo, etc. For a quote

<b>SteamSaver™ Steam Trap Jackets</b>				
<b>Inverted Bucket Style and F&amp;T Trap</b>				
<b>Part Number</b>	<b>Size</b>	<b>Manufacturer</b>	<b>Model Number</b>	<b>Price</b>
<b>Inverted Bucket Style</b>				
FAB-STJ-060905	6" x 9" x 5"	Armstrong	1810 / 1811 / 1822	\$ 65.65
FAB-STJ-080905	8" x 6" x 5"	Armstrong	800 / 811 / 880 / 881	\$ 67.22
FAB-STJ-080905	8" x 6" x 5"	Hoffman	B0 Series	\$ 67.22
FAB-STJ-080905	8" x 6" x 5"	Spence / Nicholson	80S / 81S FTN 250 / FTN 251	\$ 67.22
FAB-STJ-1057265	10.5" x 7.25" x 6.5"	Armstrong	812 / 882	\$ 92.00
FAB-STJ-1057265	10.5" x 7.25" x 6.5"	Hoffman	B1 Series	\$ 92.00
FAB-STJ-1057265	10.5" x 7.25" x 6.5"	Spence / Nicholson	82S	\$ 92.00
FAB-STJ-130975	13" x 9" x 7.5"	Armstrong	813 / 883	\$ 104.93
FAB-STJ-130975	13" x 9" x 7.5"	Hoffman	B2 Series	\$ 104.93
<b>F&amp;T Trap Style</b>				
FAB-STJ-67565725	6.75" x 6.5" x 7.25"	Armstrong	B Series	\$ 64.57
FAB-STJ-67565725	6.75" x 6.5" x 7.25"	Hoffman	FT015H thru 175H FT015H thru 030H Model 55	\$ 64.57
FAB-STJ-67565725	6.75" x 6.5" x 7.25"	Spirax Sarco	FT15 thru FT125	\$ 64.57
FAB-STJ-67565725	6.75" x 6.5" x 7.25"	Mepco / Dunham Bush	40-215 / 40-415 / 40-515	\$ 64.57
FAB-STJ-67565725	6.75" x 6.5" x 7.25"	Spence / Nicholson	FTN-15 thru FTN-30	\$ 64.57
FAB-STJ-750555	7.5" x 5" x 5.5"	Barnes & Jones	41-T / 42-T	\$ 61.77
FAB-STJ-1057555	10.5" x 7.5" x 5.5"	Barnes & Jones	43-T	\$ 91.55
FAB-STJ-9592555	9.5" x 9.25" x 5.5"	Barnes & Jones	44-T	\$ 108.56
FAB-STJ-11597565	11.5" x 9.75" x 6.5"	Barnes & Jones	FT2015-8	\$ 97.71
FAB-STJ-11597565	11.5" x 9.75" x 6.5"	Hoffman	FT015H-8	\$ 97.71
FAB-STJ-070709	7" x 7" x 9"	Barnes & Jones	FT2015-6	\$ 81.33
FAB-STJ-070709	7" x 7" x 9"	Armstrong	B5-B6	\$ 81.33
FAB-STJ-070709	7" x 7" x 9"	Hoffman	FT015H-6	\$ 81.33
FAB-STJ-454505	4.5" x 4.5" x 5"	TLV	S3	\$ 64.33
FAB-STJ-57557505	5.75" x 5.75" x 5"	TLV	S5	\$ 71.33
FAB-STJ-030310	3" x 3" x 10"	Armstrong	2011	\$ 68.28

## High Temperature Conveyor Belts PTFE and Silicone Rubber Coated Fabrics – from .002 to .045 thickness Light, Medium & Heavy Duty Coated or Porous



- We manufacture a variety of conveyor belts for applications such as screen printing, carpet fabrication, food processing, textile drying, etc.
- Splices available are Metallic, Non-Metallic and Endless.
- Tracking and Guides can be added to the belt, such as Guide Snaps, Grommets, or Silicone Rubber Guides.
- Edge Reinforcement can be heat-sealed edges, sewn & sealed fabric edge and heat sealed TFE Film edge.
- Two ply belts are available for packaging and heat-sealing applications.

### How to Order a Belt – What We Need

- Dimensions of belt
- Splice Type
- Edge Reinforcement
- Tracking/Guides
- Pulley size and type
- Any special requirements

Please Contact Us With Your Belt Details for a Quotation

## High Temperature Heat Resistant Sewing Thread

**Kevlar® - Nomex® - Fiberglass - Quartz - Stainless**



These threads are widely used in the fabrication and sewing of anything requiring high temperature capability. They are used in our own fabrication shops and we have years of experience in knowing what threads are used for which applications. Quality thread made in USA & Canada.

- Nomex® continuous is 662°F short term to 800°F.
- Kevlar® continuous is 320°F short term to 600°F.
- Fiberglass with ptfе coating continuous is 1100°F short term to 1400°F.
- 304 / Inox Stainless continuous is 1200°F short term to 1400°F.
- Quartz continuous is 1800°F short term to 2000°F.
- Alumina continuous is 2200°F short term to 2300°F.

Kevlar® and Nomex® are registered trademarks of DuPont.

**Filament Kevlar® High Temperature Heat Resistant Sewing Thread**  
**Meets MIL-T-87128 & A-A-55220**



Kevlar is a high temperature resistant aramid fiber having a unique combination of toughness, high strength and thermal stability.

Both continuous multifilament and spun versions are available for a variety of sewing operations.

Continuous multifilament is available in both soft and bonded, but only in natural yellow color.

Spun thread is available in a range of dyed colors, and some of the larger sizes are also available glazed.

Excellent resistance to mildew and aging. Prolonged exposure to sunlight causes deterioration, but the fibers are self-screening. Good abrasion resistance.

**FlameShield™ High Temperature & Heat Resistant Kevlar® Sewing Thread**  
**Filament Kevlar® - All Spools are 1 pound / 455 grams - Color Yellow**

Part Number	MIL-T-87128 Designation	Size	TEX	Diameter inch	Break Strength, Lbs	Yards per Lb	Price per Spool.
FAB-TH-KF-40-X	B/2 (200 x 2)		40		14	10,000	\$ 198.77
FAB-TH-KF-60-X	E/3 (200 x 3)		60	.008	23	6,700	\$ 198.77
FAB-TH-KF-80-X	F/4 (200 x 4)		80		30	5,000	\$ 198.77
FAB-TH-KF-120-X	FF/3 (400 x 3)		120	.012	45	3,350	\$ 154.62
FAB-TH-KFB-160	N/A		160		57	2,368	\$ 310.63
FAB-TH-KF-210-X	3 (400 x 5)		210		64	2,000	\$ 154.62
FAB-TH-KF-400-X	5 (1000 x 4)		400		135	950	\$ 115.74
FAB-TH-KF-500-X	6 (1500 x 3)		500		150	850	\$ 96.91
FAB-TH-KF-800-X	8 (1500 x 5)		800		225	500	\$ 96.91

- For the "X" Value, Specify B for Bonded, or P for Plain. Add \$22.61 per spool for bonded
- Also meets A-A-55220

Kevlar® and Nomex® are registered trademarks of DuPont.



## Spun Kevlar® High Temperature Heat Resistant Sewing Thread



Kevlar is a high temperature resistant aramid fiber having a unique combination of toughness, high strength and thermal stability.

Both continuous multifilament and spun versions are available for a variety of sewing operations.

Continuous multifilament is available in both soft and bonded, but only in natural yellow color.

Spun thread is available in a range of dyed colors, and some of the larger sizes are also available glazed.

Excellent resistance to mildew and aging. Prolonged exposure to sunlight causes deterioration, but the fibers are self-screening. Good abrasion resistance.

Spun Kevlar is in compliance with the Canadian Standards CAN/CGSB 155.1-98 and CAN/CGSB 155.22-97. Meets requirements of NFPA 1971-1991 Standard on Protective clothing and NFPA 1974-1994 Standard on Fire Fighters Uniforms.

Kevlar® is certified by Underwriters Laboratories Inc. for use in protective clothing.

### FlameShield™ High Temperature & Heat Resistant Kevlar® Sewing Thread Spun Kevlar® - All Spools are 1 pound / 455 grams - Color Yellow

Part Number	Size	TEX	Diameter inch	Break Strength, Lbs	Yards per Lb	Price per Spool.
FAB-TH-KS-35-Y	30/2	35			12,000	\$ 139.44
FAB-TH-KS-40-Y	30/2	40	0.004"	7	12,000	\$ 155.30
FAB-TH-KS-50-Y	30/3	50			8,000	\$ 155.30
FAB-TH-KS-60-Y	30/3	60	0.006"	10	8,000	\$ 155.30
FAB-TH-KS-70-Y	30/4	70	0.007"	13	5,700	\$ 155.30
FAB-TH-KS-90-X-Y	30/5	90			5,000	\$ 139.44
FAB-TH-KS-100-X-Y	30/5	100	0.008"	17	4,800	\$ 155.30
FAB-TH-KS-105-X-Y	30/6	105			4,000	\$ 139.44

Kevlar® and Nomex® are registered trademarks of DuPont.

- For the "X" Value, Specify B for Glazed, or P for Plain. Add \$19.34 per spool for bonded
- For the "Y" Value, Specify N for Natural, and C for Colored. Add \$41.72 per spool for color.

## Filament Nomex® and Spun Nomex® High Temperature Heat Resistant Sewing Thread

Meets MIL-T-83193B Type I



Nomex is a high temperature resistant fiber having a unique combination of toughness, high strength and thermal stability.

Both continuous multifilament and spun versions are available for a variety of sewing operations.

Continuous multifilament is available in both soft and bonded, but only in natural yellow color.

Spun thread is available in a range of dyed colors, and some of the larger sizes are also available glazed.

Excellent resistance to mildew and aging. Prolonged exposure to sunlight causes deterioration, but the fibers are self-screening. Good abrasion resistance.

### FlameShield™ High Temperature & Heat Resistant Sewing Thread Filament & Spun Nomex

Part Number	Material	Size	TEX	Diameter inch	Break Strength, Lbs	Yards per Lb	Price per Spool.
FAB-TH-NS-27	Spun Nomex		27		1.6	14,000	\$ 126.74
FAB-TH-NS-35	Spun Nomex		35		2.0	12,000	\$ 126.74
FAB-TH-NS-40	Spun Nomex		40		2.8	9,300	\$ 126.74
FAB-TH-NS-50	Spun Nomex		50		3.0	8,200	\$ 126.74
FAB-TH-NS-70	Spun Nomex		70		4.5	6,200	\$ 126.74
FAB-TH-NS-25* #	Spun Nomex	25	90	0.009"	6	4,850	\$167.92
FAB-TH-NB-69-N %	Bonded Nomex	69	60	0.011"	7.2	7,000	\$ 287.58
FAB-TH-NB-70-X #	Bonded Nomex	70	70	0.013"	8	4,850	\$ 221.72

# Complies with CAN/CGSB-155.1-98 / CAN/CGSB-155.22-97, Meets Mil-T-83193 & A-A-55217.

% Meets A-A-50195, Mil-T-43436

Kevlar® and Nomex® are registered trademarks of DuPont.

## High Temperature Heat Resistant Sewing Thread

Fiberglass - Quartz - Stainless



### FlameShield™ High Temperature & Heat Resistant Sewing Thread

Part Number	Material	Size	TEX	Diameter inch	Spool Weight, Lbs	Break Strength, Lbs	Yards per Lb	Natural Color	Price per Spool.
FAB-TH-FG-12	E-Fiberglass**	12	150	0.015"	2	18	2700	Gray	\$ 248.44
FAB-TH-FG-18 ****	E-Fiberglass**	18	210	0.017"	2	24	1800	Gray	\$ 248.44
FAB-TH-FG-24 *****	E-Fiberglass**	24	300	0.020"	2	30	1300	Gray	\$ 248.44
FAB-TH-FGINC-18	Fiberglass w/inconel**	18	210	0.100"	2	24	1800	Gray	\$ Call
FAB-TH-FGINC-24	Fiberglass w/inconel**	24	300	0.130"	2	30	1300	Gray	\$ Call
FAB-TH-QTZ-12	Quartz	12	150	0.014"	1	18	3450	Tan	\$ 682.34
FAB-TH-QTZ-18	Quartz	18	210	0.017"	1	24	2300	Tan	\$ 682.34
FAB-TH-QTZ-24	Quartz	24	300	0.020"	1	30	1700	Tan	\$ 682.34
FAB-TH-SSK-1064	3 strand Inox Stainless - Kevlar wrapped	1064	120	0.007"	2	28	4200	Yellow	\$ 827.58
FAB-TH-SSP-1064	10 strand 304 Stainless - Polyester wrapped	1064	120	.0145"	2	8	2150	White	\$ 627.21
FAB-TH-AL-31	Alumina	30		.031"	0.75		750	White	\$556.43

• For the "X" value, Specify NAT for Natural, BLK for Black

\* Available Natural, Black, Orange, Red, Green \*\* Coated with PTFE \*\*\* Meets A-A-55220 & MIL-T-87128

\*\*\*\* Meets MIL-Y-1140C (Form 1, Class C) \*\*\*\*\* Meets MIL-C-20079 (Type 3, Class 3)

# Complies with CAN/CGSB-155.1-98 / CAN/CGSB-155.22-97, Meets Mil-T-83193 & A-A-55217.

% Meets A-A-50195, Mil-T-43436

## Hook and Loop Closure – Nylon / Nomex®



Nylon hook and loop closure with Urethane/Acrylic backcoat with Flame Retardant additive. 225°F / 107°C Continuous; 300°F / 148°C for up to 1 hour; 459°F / 237°C melting point. Color is black. Nomex® is rated -70°F to 350°F (-56°C to 176°C)

Nylon meets the following specifications:

- MIL-F-21840 / A-A-55126 Type II Class I
- NFPA 1971-1991
- Automotive FMVSS 302
- FAA 25.853a (Aviation)
- Toxicity ATS1000 (Nylon only)

<b>FlameShield™ Nylon Hook &amp; Loop Flame Retardant Fastener</b>					
<b>Part Number</b>	<b>Material</b>	<b>Width</b>	<b>Reel length</b>	<b>Price per Reel</b>	<b>Price per Yard</b>
FAB-VHL-NY-LOOP-10-B	Nylon	5/8"	50 yards	\$ 47.97	\$ 4.79
FAB-VHL-NY-HOOK-10-B	Nylon	5/8"	50 yards	\$ 47.97	\$ 4.79
FAB-VHL-NY-LOOP-12-B	Nylon	3/4"	50 yards	\$ 56.88	\$ 5.68
FAB-VHL-NY-HOOK-12-B	Nylon	3/4"	50 yards	\$ 56.88	\$ 5.68
FAB-VHL-NY-LOOP-16-B	Nylon	1"	50 yards	\$ 66.33	\$ 6.63
FAB-VHL-NY-HOOK-16-B	Nylon	1"	50 yards	\$ 66.33	\$ 6.63
FAB-VHL-NY-LOOP-32-B	Nylon	2"	50 yards	\$ 126.61	\$ 12.66
FAB-VHL-NY-HOOK-32-B	Nylon	2"	50 yards	\$ 126.61	\$ 12.66
<b>FlameShield™ Nomex® Hook &amp; Loop Fastener - White Color</b>					
<b>Transportation Use - Aviation / Rail / Ground / Marine</b>					
<b>Meets FAR 25.853 / Boeing DMS1982 Rev G / AA-55126B -70°F to 350°F (-56°C to 176°C)</b>					
FAB-VHL-NM-HOOK-16	Nomex®	1	50 yards	\$ 337.50	\$ 13.50
FAB-VHL-NM-LOOP-16	Nomex®	1	50 yards	\$ 466.20	\$ 18.65
FAB-VHL-NM-HOOK-32	Nomex®	2	50 yards	\$ 652.50	\$ 26.10
FAB-VHL-NM-LOOP-32	Nomex®	2	50 yards	\$ 765.00	\$ 30.60

## FlameShield™ Nylon Hook & Loop Specification

### Strength

#### Sample Condition

Dry (ASTM 5169 & 5170) Peel: 1.0 lb/in width Shear: 13.8 lb/in<sup>2</sup>

3 laundering (AATCC-61/3A)  
plus 3 Dry Clean (AATCC-  
132) then 2,000 cycles

Peel: 0.67 lb/in width Shear: 8.3 lb/in<sup>2</sup>

### Dimensions

Hook size: 8mil (.008") / 0.22 mm  
Available Widths: 5/8", 3/4", 1", 1 1/2", 2", 4"  
Hook Thickness: 0.077in (1.95mm)  
Loop Thickness: 0.098 in (2.5mm)

### Materials

Hook: Nylon, Woven  
Backcoat: Urethane/Acrylic with F/R additive (type 2)  
Hooks/in<sup>2</sup>: 220

Loop: Nylon, Woven  
Backcoat: Urethane/Acrylic with F/R additive (type 2)

### Properties

Steralization: Gamma (Mrad): Yes  
Autoclave: Yes

Chemical Resistance: **Acid** – Resistant to weak acids. Dissolved in mineral acids. Avoid concentrated acids  
**Alkali** – Resistant to strong alkalis – recommend pH < 12.5 Temperature < 160°F  
**Oxidizers** – Moderate resistance. Degraded by strong oxidizers. Keep temperature < 100°F  
**Solvents** – Resistant to most common solvents. Less resistant to chlorinated solvents.

Fray Resistance: MIL F 21840: < 1/32 after 5 launderings

Operating Temperature: 225°F Continuous, 300°F < 1 hour, 459°F Melting Point

Shrinkage at boil: ASTM D2259; 1.5 – 2% at boil.

### Certifications

MIL F 21840 / CID A-A-55126 Type II Class I

NFPA 1971 – 1991 Approved: NFPA 1975, 1977, 1976, 1971

Flammability: Automotive / FMVSS 302  
FAA / 25.853B

Toxicity: ATS1000



## Hook and Loop Closure – Stainless Steel

Heat, Flame and Chemical Resistant



Stainless Steel hook & Loop –  
heat and chemical resistance

-70°F to 800°F (-56°C to 426°C)

- MIL-F-21840 / A-A-55126  
Type II Class I
- NFPA 1971-1991
- Automotive FMVSS 302
- FAA 25.853a (Aviation)

<b>FlameShield™ Stainless Steel Yarn Hook &amp; Loop Fastener</b>					
<b>Flame / Fire / Chemical Resistant</b>					

Part Number	Material	Width	Reel length	Price per Reel	Price per Yard
FAB-VHL-SS-HOOK-16	Stainless Steel	1	25 yards	\$ 1247.00	\$ 96.87
FAB-VHL-SS-LOOP-16	Stainless Steel	1	25 yards	\$ 1247.00	\$ 96.87

## High Temperature Heat & Flame Resistant Zippers

Metal teeth mounted on Nomex® support tape  
Maximum temperature 650°F / 343°C

Meets NFPA 1971, 1975, 1977, 1951, 1999  
CGSB 155.1, 155.2, 155.22. ASTM F1506, 1891. NFPA 70E, 2112, FMVSS 302  
(Automotive), 25.853B FAA

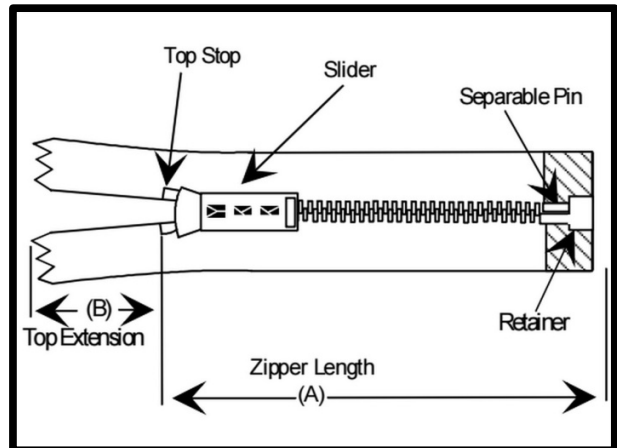

Brass Elements (Top Stop, Teeth, Slider, Retainer Ends) except slider spring and lock pin are stainless steel. Mounted on Nomex® tape.

### Made to custom length:

Minimum length 8 inches. Maximum length 100 inches. Top extension 1 inch. Width 1 1/8 inch.

Minimum order is \$100 – sizes may be mixed.

FlameShield™ High Temperature & Flame Retardant Zipper	
Part Number	Price per Foot
FAB-ZIP-X	\$ 3.31

- For the “X” value, Specify length in inches

Delivery time approximately 4 weeks

**Scissors / Shears / Cutters**  
Designed for cutting of Sleeve, Tape, Rope & Fabrics

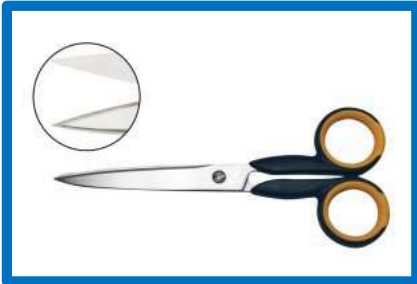

Scissors- Shears for Cutting and Trimming					
Part Number	Type	Blade	Length	Cutting Length	Price
Kevlar Cutting					
TL-S-KEV-104	Snips	Straight – 1 serrated	6 ½"	0.875"	\$ 51.66
TL-S-KEV-2715	Scissors	Straight – 1 serrated	6"	2.6"	\$ 26.00
TL-S-KEV-2915	Scissors	Straight – 2 serrated	6"	2.6"	\$ 28.00
TL-S-KEV-2720	Offset Shear	Straight – 1 serrated	8"	3.3"	\$ 28.00
TL-S-KEV-2920	Offset Shear	Straight – 2 serrated	8"	3.3"	\$ 30.00
TL-S-KEV-HD-4720	HD Offset Shear	Straight – 1 serrated	8"	3.5"	\$ 64.00
TL-S-KEV-HD-4920	HD Offset Shear	Straight – 2 serrated	8"	3.5"	\$ 66.00
TL-S-KEV-HD-3725	HD Offset Shear	Straight – 1 serrated	10"	4.9"	\$ 52.00
TL-S-KEV-HD-3925	HD Offset Shear	Straight – 2 serrated	10"	4.9"	\$ 54.00
TL-S-KEV-HD-4730	HD Offset Shear	Straight – 1 serrated	12"	5.5"	\$ 77.00
TL-S-KEV-HD-4930	HD Offset Shear	Straight – 2 serrated	12"	5.5"	\$ 79.00

These scissors and shears are suitable for cutting most of our fiberglass, silica and ceramic products such as sleeve, tape, rope and fabric, plain and coated. They are especially useful for cutting Kevlar.

Kevlar products are difficult to cut due to their strength. Regular or heavy duty scissors can sometimes cut these materials, but often fail quickly as the Kevlar quickly dulls the cutting edge.

Kevlar Shears are specifically designed to cut Kevlar, and feature either one serrated blade or two serrated blades so that the fibers don't slip while cutting, holding the fiber in position and allowing for a greater shear force to be applied by the opposing blade.

These shears are Extra Heavy Duty, and can be used for other materials such as cutting steel wires and steel tie wraps.

The shears highlighted in **Yellow** are our most popular selling models for all fabric, sleeve and tape materials, and especially for Kevlar.

## Stainless Steel Snaps

### FlameShield™ Snap Caps, Posts, Sockets, Studs & Setting Tools Meets MIL-10884, MS27980 Style 2



Used to make fabrications and covers.

A set comprises a Cap / Socket on one side of the fabrication and a Post / Stud or a Screw Stud on the other side of the component.



- Standard material is Stainless Steel; other finishes such as Brass and Nickel Plate is available
- Standard Cap diameter is 0.6" / 15.24mm. Smaller is available
- Standard stud height is 0.24" / 6.1mm and is self piercing so no pre-punching of attached material is required.



FlameShield™ Snap Caps, Posts, Sockets, Studs & Setting Tools				
Part Number	Material	Diameter inch / mm	Height inch / mm	Price
FAB-SNAP-SS-CAP	Stainless Steel	.6 / 15.24	.24 / 6.1	\$ 27.00 / 100 pack
FAB-SNAP-SS-SOCKET	Stainless Steel			\$ 15.00 / 100 pack
FAB-SNAP-SS-POST	Stainless Steel	.555 / 14.10	.24 / 6.1	\$ 27.00 / 100 pack
FAB-SNAP-SS-STUD	Stainless Steel			\$ 15.00 / 100 pack
FAB-SNAP-BTOOL	Bench Tool			\$ 319.66
FAB-SNAP-HTOOL	Hand Tool			\$ 307.72
FAB-SNAP-DIESET	Die Set			\$ 231.62

Please inquire about screw studs

## Commercial Kitchen Duct Sealant & Gaskets



Generally, most city and municipal codes and regulations call for gaskets that are used within commercial kitchen ducts must withstand 1500°F exposure.

Most duct work is fabricated in 4 construction styles:

1. Butt fit duct with offset flange lip
2. Overlap fit
3. Butt fit with flush flange lips
4. Cone flange (fan unit attachment)

Traditional high temperature fabric gaskets can be used successfully by utilizing a high temperature non-flammable sealant to form a barrier.

DuctSeal™ high temperature paste sealant will withstand continuous exposure to 460°F, and provides a flexible barrier to grease migration into the flange gasket. In the event of a fire, the sealant will break down into silicon dioxide, a white –grey powdery refractory insulating material. Even with the sealant deteriorated, the high temperature gasket remains in place and provides the barrier to flame migration through the duct flange joint. DuctSeal™ paste must not be used as the primary seal/gasket on the duct flange surfaces – a separate high temperature gasket must be used in conjunction with DuctSeal™ paste.

As most duct flanges are fastened together with ¼” carbon steel or stainless steel bolts and associated hardware, and most flanges are 1”, 1 ¼” or 1 ½” wide, the easiest gasket to use is a LadderTape gasket, which has a loose ladder construction in the center of the tape to allow for easy passing of the fastening bolts through it.

Tapes are also available with a Pressure Sensitive Adhesive (acrylic) which allows for easy the installation of the tape.

DuctSeal™ gasket tapes are available in 1800°F, 2000°F and 2300°F versions. Most installers prefer the LadderTape™ version of the gasket for ease of installation, but some installers may prefer traditional plain tapes, one on each side of the bolt-hole line.



## DuctSeal™ High Temperature Sealant / Paste: Commercial Kitchen Silicone Sealant



### DuctSeal™ Paste Duct Flange Sealant Paste

This sealant is used to form a bead ahead of the gasket tape in the flange area of commercial kitchen grease ducts in order to keep grease from contaminating the gasket tape.

Can be used to 500°F continuous without degradation.

In the event of a fire, the elevated temperatures will decompose the sealant, turning it into a white insulating powder through a process called caramelization.

During the fire, the gasket tape itself will maintain the seal in the flange. The sealant is available in Oxide-Red and Black.



Available in two sizes:

- 3 oz squeeze tube.  
P/N US-DSP-03-OR \$16.61
- 10.3 oz caulking gun cartridge.  
P/N US-DSP-10-OR \$37.47

### US-DSP paste meets the following specifications:

- MIL-A-46106A
- TT-S-001543A
- TT-S-00230C
- FDA Extractive Requirements CFR 177.2600
- USDA Rating P-1
- NSF/ANSI STD 51

## DuctSeal™ Grease Duct Access Doors



- Heavy Duty 16 gauge steel construction
- Stainless Steel models available
- Available with extended studs to accommodate fire wrap
- Back frame reinforces duct cut-out
- Easy to clean and install
- Standard and custom sizes available
- Gasket rated to 2300°F and is bonded to front panel

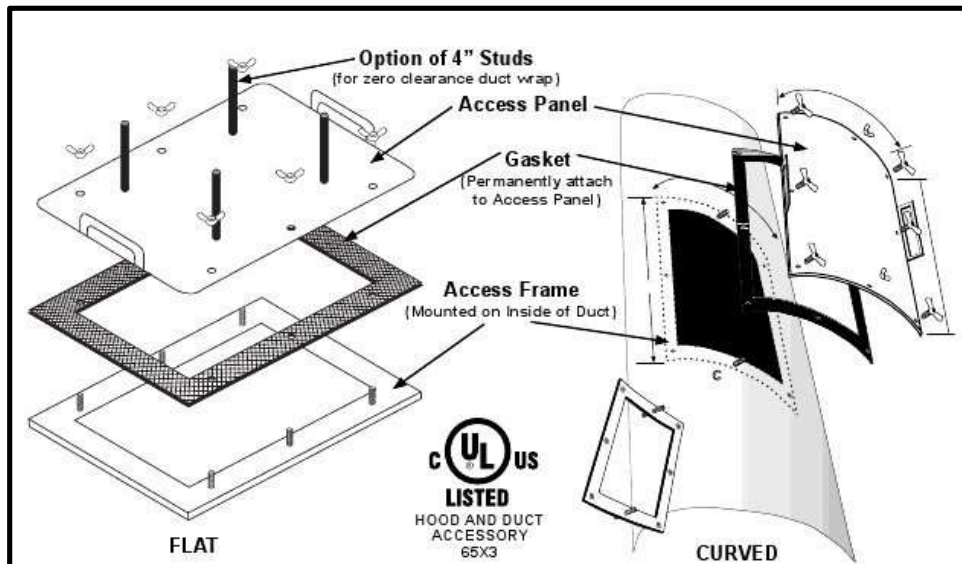

### Pricing:

Flat Access Doors		Curved Access Doors	
DUCTDOOR-F-1	\$ 140.00	DUCTDOOR-C-1	\$ 216.00
DUCTDOOR-F-2	\$ 160.00	DUCTDOOR-C-2	\$ 216.00
DUCTDOOR-F-3	\$ 204.00	DUCTDOOR-C-3	\$ 288.00
DUCTDOOR-F-4	\$ 144.00	DUCTDOOR-C-4	\$ 220.00
DUCTDOOR-F-5	\$ 140.00	DUCTDOOR-C-5	\$ 272.00
DUCTDOOR-F-6	\$ 160.00	DUCTDOOR-C-6	\$ 276.00
DUCTDOOR-F-7	\$ 208.00	DUCTDOOR-C-7	\$ 284.00
DUCTDOOR-F-8	\$ 188.00	DUCTDOOR-C-8	\$ 298.00
DUCTDOOR-F-9	\$ 252.00	DUCTDOOR-C-9	\$ 312.00
DUCTDOOR-F-10	\$ 268.00	DUCTDOOR-C-10	\$ 298.00
DUCTDOOR-F-11	\$ 272.00	DUCTDOOR-C-11	\$ 364.00

**Flat Doors**

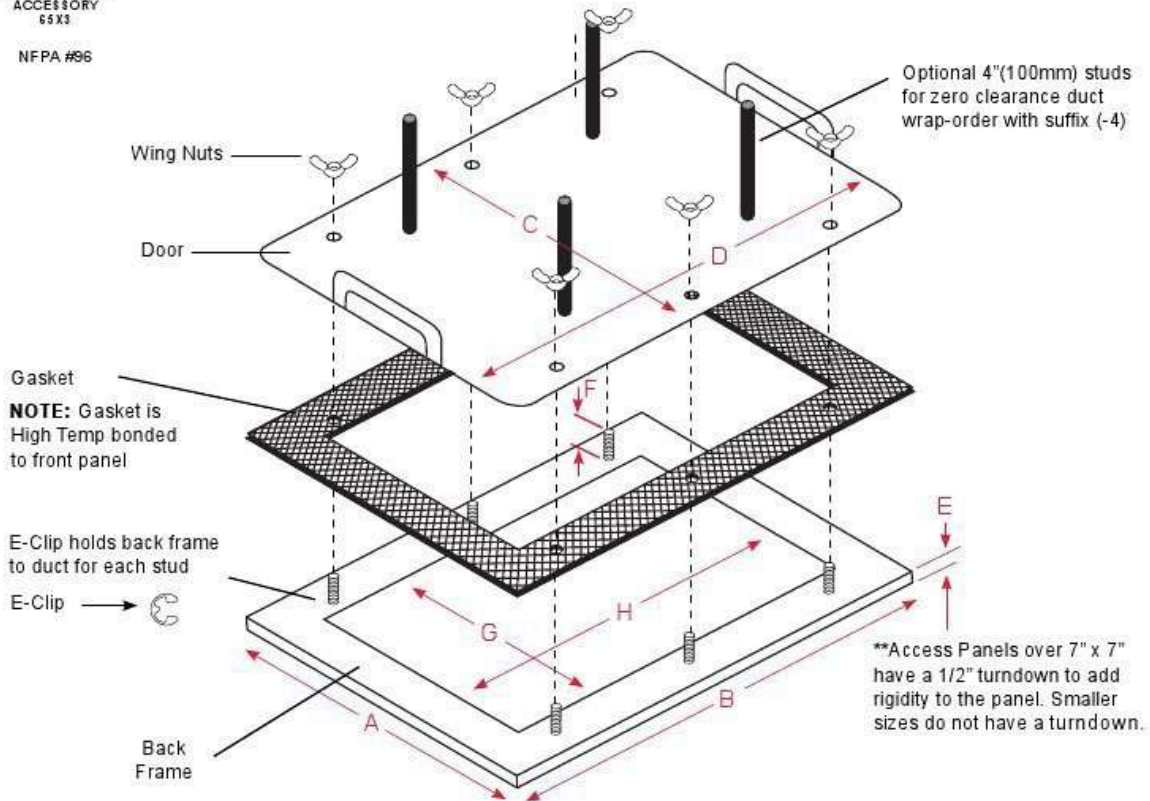

Please Order by Part No.	BACK FRAME OUTSIDE DIMENSION		FRONT PANEL OUTSIDE DIMENSION		PANEL WIDTH	STUD HEIGHT	HOLE SIZE • BACK FRAME INSIDE DIMENSION		MOUNTING STUDS
	A*	B*	C	D			G	H	
DUCTDOOR-F-1	7"	10"	7"	10"	Flat	1"	5.5"	8.5"	6
DUCTDOOR-F-2	7"	15"	7"	15"	Flat	1"	5.5"	13.5"	6
DUCTDOOR-F-3	7"	23"	7"	23"	Flat	1"	5.5"	21.5"	10
DUCTDOOR-F-4	8"	8"	8"	8"	Flat	1"	6"	6"	4
DUCTDOOR-F-5	10"	10"	10"	10"	.5"	1"	7"	7"	4
DUCTDOOR-F-6	10"	15"	10"	15"	.5"	1"	7"	12"	6
DUCTDOOR-F-7	10"	23"	10"	23"	.5"	1"	7"	20"	10
DUCTDOOR-F-8	15"	15"	15"	15"	.5"	1"	12"	12"	8
DUCTDOOR-F-9	15"	23"	15"	23"	.5"	1"	12"	20"	14
DUCTDOOR-F-10	19"	23"	19"	23"	.5"	1"	16"	20"	16
DUCTDOOR-F-11	23"	23"	23"	23"	.5"	1"	20"	20"	16

**Curved Doors**



NFPA #96

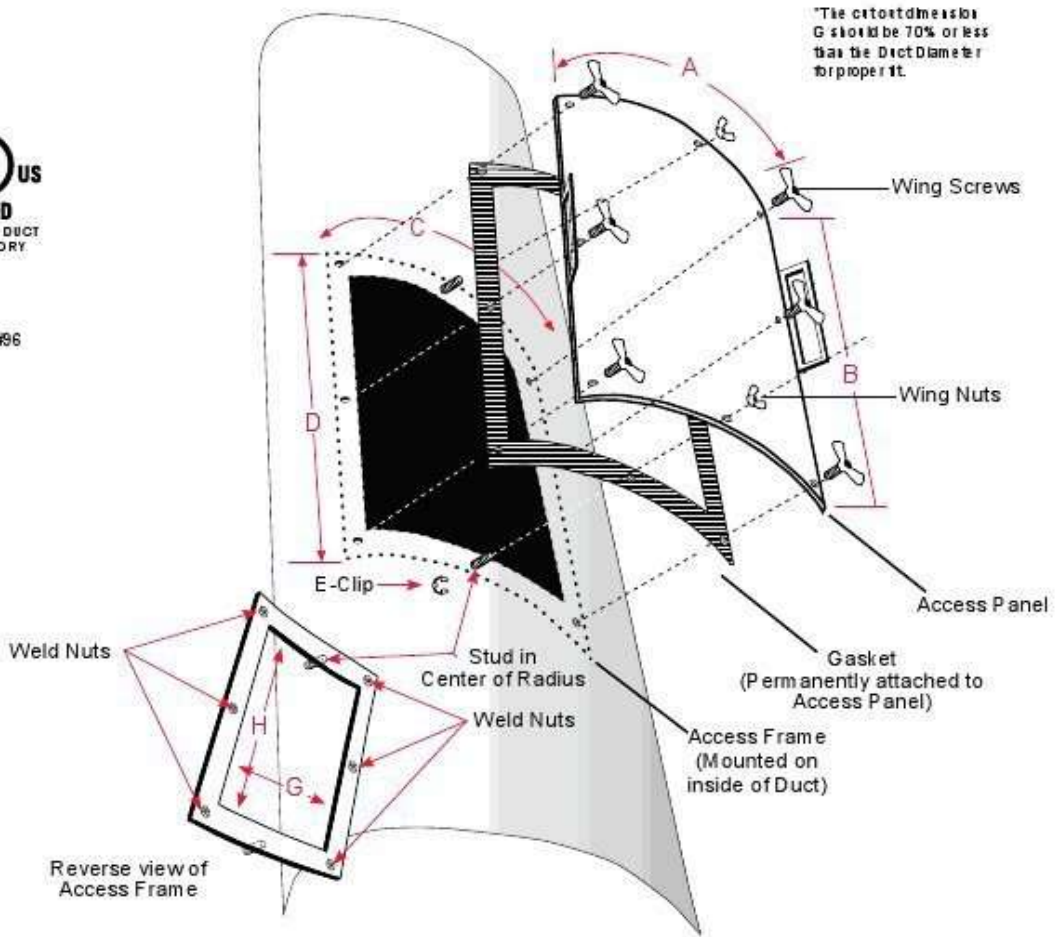

Please Order by Part No.	OUTSIDE DIMENSIONS				HOLE SIZE INSIDE DIMENSIONS	
	PART NO.	A	B	C	D	G*
DUCTDOOR-C-1	6.56"	6.75"	6.56"	6.75"	5.06"	5.25"
DUCTDOOR-C-2	6.50"	12.75"	6.50"	12.75"	5.00"	11.25"
DUCTDOOR-C-3	6.50"	18.75"	6.50"	18.75"	5.00"	17.25"
DUCTDOOR-C-4	9.50"	9.75"	9.50"	9.75"	8.00"	8.25"
DUCTDOOR-C-5	9.50"	12.75"	9.50"	12.75"	8.00"	11.25"
DUCTDOOR-C-6	9.50"	18.75"	9.50"	18.75"	8.00"	17.25"
DUCTDOOR-C-7	9.50"	24.75"	9.50"	24.75"	8.00"	23.25"
DUCTDOOR-C-8	12.50"	18.75"	12.50"	18.75"	11.00"	17.25"
DUCTDOOR-C-9	12.50"	24.75"	12.50"	24.75"	11.00"	23.25"
DUCTDOOR-C-10	18.50"	18.75"	18.50"	18.75"	17.00"	17.25"
DUCTDOOR-C-11	18.50"	24.75"	18.50"	24.75"	17.00"	23.25"



**Custom Door Quote: Flat Doors**

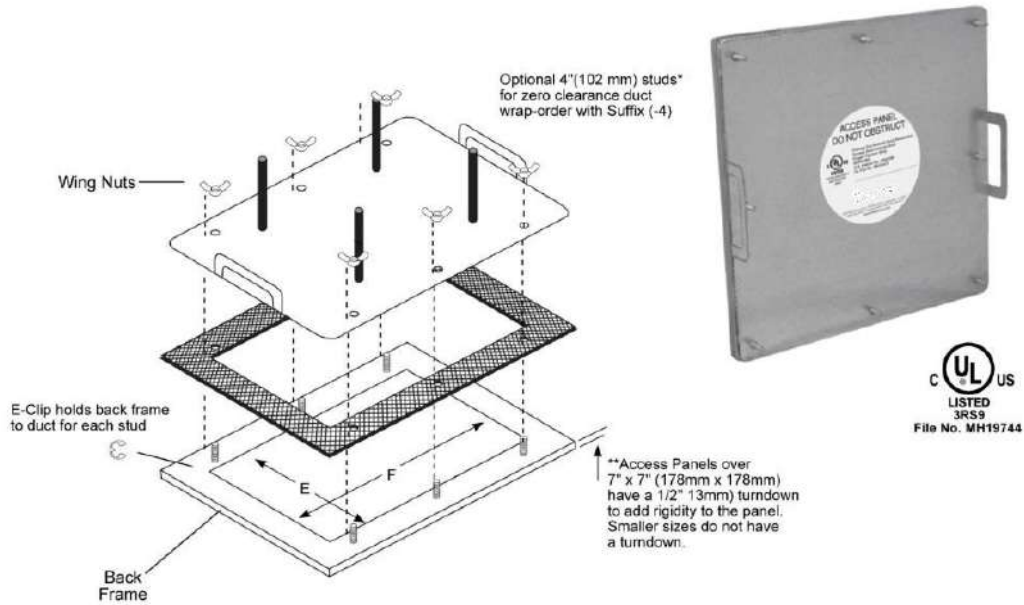

DIMENSIONS	SIZE	INCHES or MM
DIMENSION "E"		
DIMENSION "F"		

QUANTITY REQUIRED	DESCRIPTION
	16 GA. GALVANIZED STEEL WITH ZINC PLATED STEEL MOUNTING HARDWARE
	16 GA. 304 STAINLESS STEEL WITH 304 STAINLESS STEEL MOUNTING HARDWARE
	18 GA. 304 STAINLESS STEEL WITH 304 STAINLESS STEEL MOUNTING HARDWARE

*Additional Notes*

Date:	P.O. #	Account No:
Company Name:	Contact Name:	
Address:	City & State:	Zip:
Phone No:	E-mail:	



**Custom Door Quote: Curved Doors**

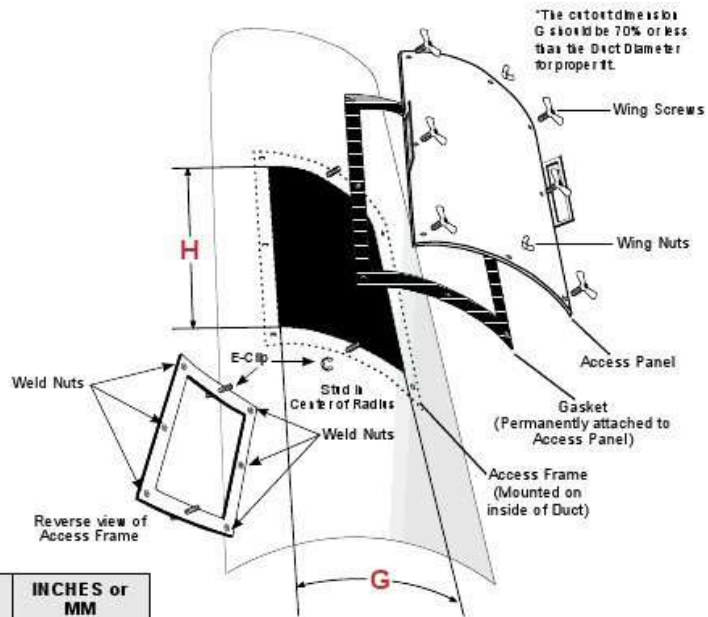

DIMENSIONS	SIZE	INCHES or MM
DUCT DIAMETER "A"		
CUT OUT DIMENSION "G" "G" = 70% x "A" or LESS		
IF LESS THAN 70% GIVE SIZE		
CUT OUT DIMENSION "H"		

NFPA 96 prohibits duct cut out greater than 70% of the duct diameter

<b>QUANTITY REQUIRED</b>	
--------------------------	--

PANEL MATERIAL	Check One
GALVANIZED STEEL	<input type="checkbox"/>
STAINLESS STEEL 304	<input type="checkbox"/>
STAINLESS STEEL 316L	<input type="checkbox"/>

PANEL THICKNESS	Check One
.050" (1.3mm) S/S Models only	<input type="checkbox"/>
.060" (1.5mm)	<input type="checkbox"/>
.125" (3.2mm)	<input type="checkbox"/>

MOUNTING HARDWARE MATERIAL	Check One
ZINC PLATED STEEL	<input type="checkbox"/>
STAINLESS STEEL 304	<input type="checkbox"/>
STAINLESS STEEL 316L	<input type="checkbox"/>

*Additional Notes*

---

Date:	PO. #	Account No:
Company Name:	Contact Name:	
Address:	City & State:	Zip:
Phone No:	E-mail:	

DuctSeal™ Applications:

Apply a bead of sealant at this point around the perimeter of the duct/flange location

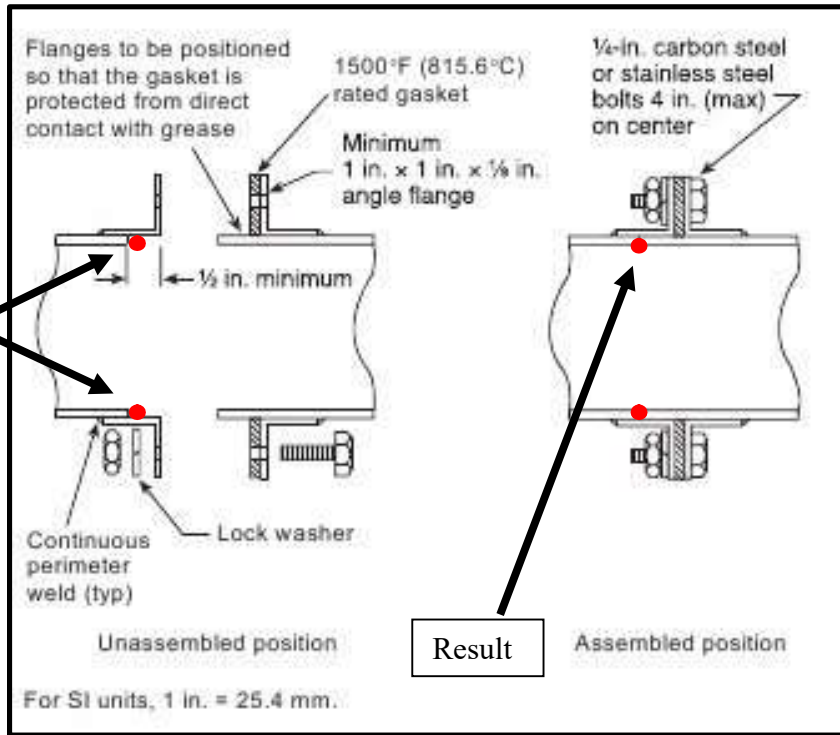

Apply a bead of sealant at this point around the perimeter of the duct/gasket location

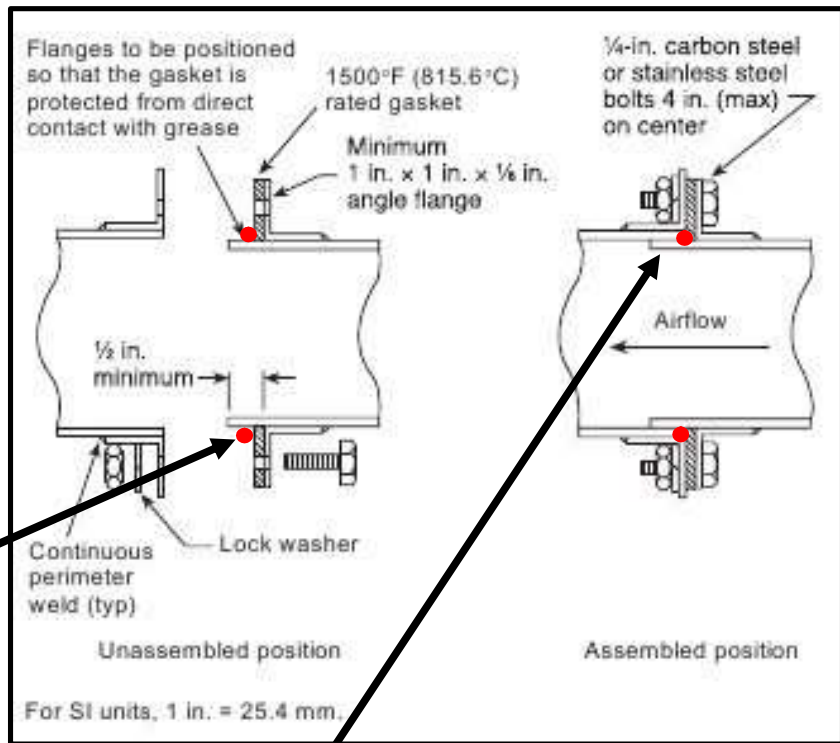

Apply a bead of sealant at this point around the perimeter of the flange, at the base of the gasket.

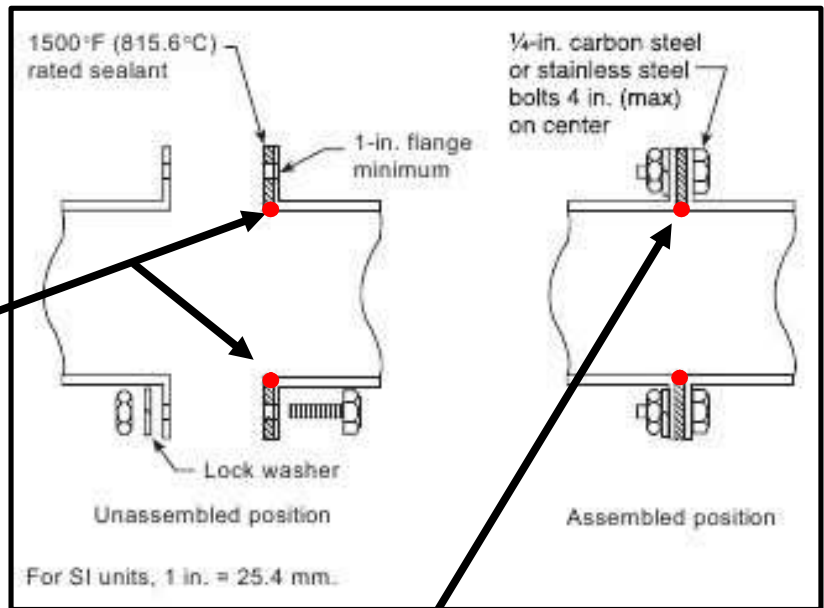

Result

Apply a bead of sealant at this point around the perimeter of the cone.

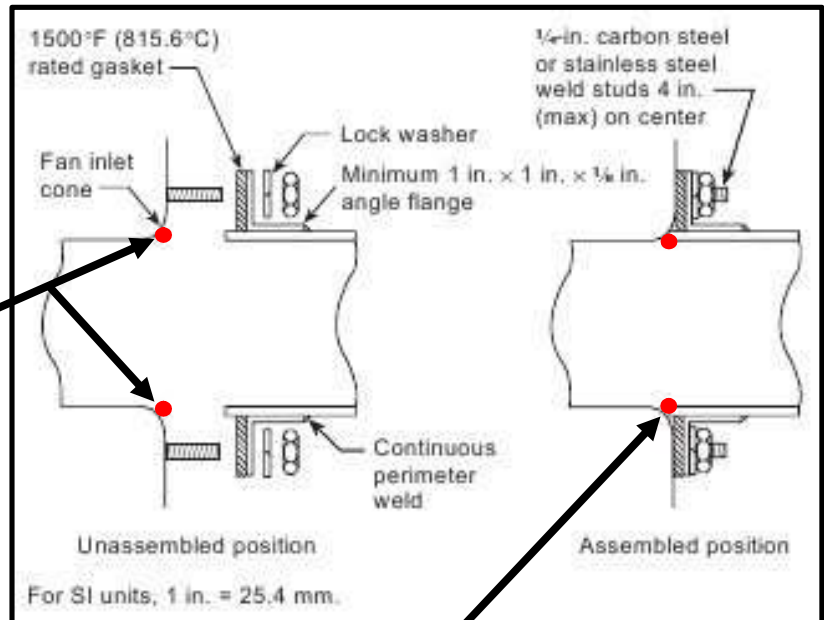

Result

# High Temperature, Heat, Flame, Fire, Molten Metal & Weld Splatter Protection Materials

Fax Orders: 610-340-9054 Telephone Orders: 610-906-3549 [orders@abthermal.com](mailto:orders@abthermal.com)

---

---

# Section 8

## Ceramic Materials

Alumina High Temperature Non Conductive Fasteners – Bolts – Nuts - Washers .....	8-1
750°F / 400°C Glass-Ceramic Plate & Rod.....	8-2
1100°F / 593°C Glass-Ceramic Plate & Rod.....	8-2
Aluminum Silicate .....	8-3
Fired Alumina .....	8-4
Zirconium Phosphate .....	8-5
Boron Nitride / Aluminum Nitride.....	8-6
Alumina and Magnesium Oxide Crucibles .....	8-7





**Thermal, EMI/RFI & Abrasion Protection Materials**

Fax Orders: 610-340-9054 Telephone Orders: 610-906-3549 [orders@abthermal.com](mailto:orders@abthermal.com)

---

## CerMax™ High Temperature Non Conductive Alumina & Zirconia Fasteners: Nuts, Bolts, Washers English & Metric



- High temperature use to 3000°F / 1649°C.
- English and Metric Sizes; Other sizes available.
- Alumina fasteners are 100% molded – then fired. No machining or grinding.
- Full Fired 99.8% Alumina & Zirconia, Non Conductive.
- **Minimum order is \$250.00 –mixing of pieces allowed**
- **All sales final. No warranty offered or implied**

CerMax™ High Temperature Non Conductive Ceramic Fasteners - Alumina							
English (Other Sizes Available – Please Ask)				Metric (Other Sizes Available – Please Ask)			
Part Number	Type	Size	Price	Part Number	Type	Size	Price
FST-CA-E-N-0-80	Nut	0-80	\$ 18.64	FST-CA-M-N-2	Nut	2 mm	\$ 20.60
FST-CA-E-N-2-56	Nut	2-56	\$ 19.80	FST-CA-M-N-3	Nut	3 mm	\$ 22.40
FST-CA-E-N-4-40	Nut	4-40	\$ 21.80	FST-CA-M-N-4	Nut	4 mm	\$ 24.80
FST-CA-E-N-5-40	Nut	5-40	\$ 22.08	FST-CA-M-N-5	Nut	5 mm	\$ 26.00
FST-CA-E-N-6-32	Nut	6-32	\$ 24.00	FST-CA-M-N-6	Nut	6 mm	\$ 27.60
FST-CA-E-N-8-32	Nut	8-32	\$ 25.00	FST-CA-M-N-8	Nut	8 mm	\$ 28.38
FST-CA-E-N-10-32	Nut	10-32	\$ 26.00				
FST-CA-E-N-1/4-20	Nut	1/4-20	\$ 27.00				
FST-CA-E-N-5/16-18	Nut	5/16-18	\$ 28.12				
FST-CA-E-N-3/8-16	Nut	3/8-16	\$ 29.12				
FST-CA-E-W-0-80	Washer	0-80	\$ 3.99	FST-CA-M-W-2	Washer	2 mm	\$ 5.20
FST-CA-E-W-2-56	Washer	2-56	\$ 4.15	FST-CA-M-W-3	Washer	3 mm	\$ 5.40
FST-CA-E-W-4-40	Washer	4-40	\$ 4.48	FST-CA-M-W-4	Washer	4 mm	\$ 6.40
FST-CA-E-W-5-40	Washer	5-40	\$ 4.65	FST-CA-M-W-5	Washer	5 mm	\$ 7.40
FST-CA-E-W-6-32	Washer	6-32	\$ 4.98	FST-CA-M-W-6	Washer	6 mm	\$ 7.66
FST-CA-E-W-8-32	Washer	8-32	\$ 5.31	FST-CA-M-W-8	Washer	8 mm	\$ 7.97
FST-CA-E-W-10-32	Washer	10-32	\$ 5.81				
FST-CA-E-W-1/4-20	Washer	1/4-20	\$ 6.16				
FST-CA-E-W-5/16-18	Washer	5/16-18	\$ 7.49				
FST-CA-E-W-3/8-16	Washer	3/8-16	\$ 8.32				

CerMax™ High Temperature Non Conductive Ceramic Fasteners - Zirconia							
English (Other Sizes Available – Please Ask)				Metric (Other Sizes Available – Please Ask)			
Part Number	Type	Size	Price	Part Number	Type	Size	Price
FST-CZ-E-N-2-56	Nut	2-56	\$ 27.06	FST-CZ-M-N-2	Nut	2 mm	\$ 26.56
FST-CZ-E-N-4-40	Nut	4-40	\$ 29.55	FST-CZ-M-N-3	Nut	3 mm	\$ 29.88
FST-CZ-E-N-6-32	Nut	6-32	\$ 31.54	FST-CZ-M-N-4	Nut	4 mm	\$ 34.36
FST-CZ-E-N-8-32	Nut	8-32	\$ 35.03	FST-CZ-M-N-5	Nut	5 mm	\$ 42.33
FST-CZ-E-N-10-32	Nut	10-32	\$ 40.50	FST-CZ-M-N-6	Nut	6 mm	\$ 48.14
FST-CZ-E-N-1/4-20	Nut	1/4-20	\$ 48.47	FST-CZ-M-W-2	Washer	2 mm	\$ 12.45
FST-CZ-E-W-2-56	Washer	2-56	\$ 12.78	FST-CZ-M-W-3	Washer	3 mm	\$ 14.94
FST-CZ-E-W-4-40	Washer	4-40	\$ 14.28	FST-CZ-M-W-4	Washer	4 mm	\$ 20.25
FST-CZ-E-W-6-32	Washer	6-32	\$ 17.43	FST-CZ-M-W-5	Washer	5 mm	\$ 25.56
FST-CZ-E-W-8-32	Washer	8-32	\$ 20.75	FST-CZ-M-W-6	Washer	6 mm	\$ 30.05
FST-CZ-E-W-10-32	Washer	10-32	\$ 24.90				
FST-CZ-E-W-1/4-20	Washer	1/4-20	\$ 29.71				

CerMax™ High Temperature Non Conductive Ceramic Fasteners - Alumina							
English (Other Sizes Available – Please Ask)				Metric (Other Sizes Available – Please Ask)			
Part Number	Type	Size	Price	Part Number	Type	Size	Price
FST-CA-E-B-0-80x1/4	Bolt	0-80 x 1/4	\$ 28.72	FST-CA-M-B-2X5	Bolt	2 mm x 5 mm	\$ 35.00
FST-CA-E-B-2-56x1/4	Bolt	2-56 x 1/4	\$ 32.80	FST-CA-M-B-2X10	Bolt	2 mm x 10 mm	\$ 38.60
FST-CA-E-B-2-56x3/8	Bolt	2-56 x 3/8	\$ 35.00	FST-CA-M-B-3X5	Bolt	3 mm x 5 mm	\$ 38.80
FST-CA-E-B-2-56x1/2	Bolt	2-56 x 1/2	\$ 38.80	FST-CA-M-B-3X10	Bolt	3 mm x 10 mm	\$ 43.40
FST-CA-E-B-4-40x1/4	Bolt	4-40 x 1/4	\$ 34.80	FST-CA-M-B-3X20	Bolt	3 mm x 20 mm	\$ 47.00
FST-CA-E-B-4-40x3/8	Bolt	4-40 x 3/8	\$ 37.40	FST-CA-M-B-3X25	Bolt	3 mm x 25 mm	\$ 49.40
FST-CA-E-B-4-40x1/2	Bolt	4-40 x 1/2	\$ 41.40	FST-CA-M-B-4X5	Bolt	4 mm x 5 mm	\$ 43.20
FST-CA-E-B-4-40x3/4	Bolt	4-40 x 3/4	\$ 45.60	FST-CA-M-B-4X10	Bolt	4 mm x 10 mm	\$ 47.60
FST-CA-E-B-4-40x1	Bolt	4-40 x 1	\$ 48.00	FST-CA-M-B-4X20	Bolt	4 mm x 20 mm	\$ 51.80
FST-CA-E-B-5-40x1/4	Bolt	5-40 x 1/4	\$ 33.53	FST-CA-M-B-4X25	Bolt	4 mm x 25 mm	\$ 54.40
FST-CA-E-B-5-40x3/8	Bolt	5-40 x 3/8	\$ 36.02	FST-CA-M-B-4X30	Bolt	4 mm x 30 mm	\$ 56.80
FST-CA-E-B-5-40x1/2	Bolt	5-40 x 1/2	\$ 39.84	FST-CA-M-B-4X40	Bolt	4 mm x 40 mm	\$ 60.20
FST-CA-E-B-5-40x3/4	Bolt	5-40 x 3/4	\$ 43.33	FST-CA-M-B-5X5	Bolt	5 mm x 5 mm	\$ 46.20
FST-CA-E-B-5-40x1	Bolt	5-40 x 1	\$ 45.98	FST-CA-M-B-5X10	Bolt	5 mm x 10 mm	\$ 50.80
FST-CA-E-B-6-32x1/4	Bolt	6-32 x 1/4	\$ 38.40	FST-CA-M-B-5X20	Bolt	5 mm x 20 mm	\$ 54.60
FST-CA-E-B-6-32x3/8	Bolt	6-32 x 3/8	\$ 41.60	FST-CA-M-B-5X25	Bolt	5 mm x 25 mm	\$ 57.20
FST-CA-E-B-6-32x1/2	Bolt	6-32 x 1/2	\$ 46.20	FST-CA-M-B-5X30	Bolt	5 mm x 30 mm	\$ 59.80
FST-CA-E-B-6-32x3/4	Bolt	6-32 x 3/4	\$ 50.00	FST-CA-M-B-5X40	Bolt	5 mm x 40 mm	\$ 63.40
FST-CA-E-B-6-32x1	Bolt	6-32 x 1	\$ 52.40	FST-CA-M-B-6X5	Bolt	6 mm x 5 mm	\$ 49.00
FST-CA-E-B-8-32x1/4	Bolt	8-32 x 1/4	\$ 40.80	FST-CA-M-B-6X10	Bolt	6 mm x 10 mm	\$ 54.40
FST-CA-E-B-8-32x3/8	Bolt	8-32 x 3/8	\$ 43.80	FST-CA-M-B-6X20	Bolt	6 mm x 20 mm	\$ 58.40
FST-CA-E-B-8-32x1/2	Bolt	8-32 x 1/2	\$ 49.00	FST-CA-M-B-6X25	Bolt	6 mm x 25 mm	\$ 60.60
FST-CA-E-B-8-32x3/4	Bolt	8-32 x 3/4	\$ 53.00	FST-CA-M-B-6X30	Bolt	6 mm x 30 mm	\$ 63.80
FST-CA-E-B-8-32x1	Bolt	8-32 x 1	\$ 55.80	FST-CA-M-B-6X40	Bolt	6 mm x 40 mm	\$ 66.40
FST-CA-E-B-8-32x1-1/4	Bolt	8-32 x 1-1/4	\$ 58.00	FST-CA-M-B-6X50	Bolt	6 mm x 50 mm	\$ 69.80
FST-CA-E-B-8-32x1-1/2	Bolt	8-32 x 1-1/2	\$ 60.20	FST-CA-M-B-6X60	Bolt	6 mm x 60 mm	\$ 73.20
FST-CA-E-B-10-32x1/4	Bolt	10-32 x 1/4	\$ 42.60	FST-CA-M-B-6X75	Bolt	6 mm x 75 mm	\$ 77.40
FST-CA-E-B-10-32x3/8	Bolt	10-32 x 3/8	\$ 46.00	FST-CA-M-B-8X5	Bolt	8 mm x 5 mm	\$ 48.84
FST-CA-E-B-10-32x1/2	Bolt	10-32 x 1/2	\$ 51.00	FST-CA-M-B-8X10	Bolt	8 mm x 10 mm	\$ 55.11
FST-CA-E-B-10-32x3/4	Bolt	10-32 x 3/4	\$ 55.20	FST-CA-M-B-8X20	Bolt	8 mm x 20 mm	\$ 58.57
FST-CA-E-B-10-32x1	Bolt	10-32 x 1	\$ 58.40	FST-CA-M-B-8X25	Bolt	8 mm x 25 mm	\$ 60.22
FST-CA-E-B-10-32x1-1/4	Bolt	10-32 x 1-1/4	\$ 60.40	FST-CA-M-B-8X30	Bolt	8 mm x 30 mm	\$ 62.70
FST-CA-E-B-10-32x1-1/2	Bolt	10-32 x 1-1/2	\$ 62.80	FST-CA-M-B-8X40	Bolt	8 mm x 40 mm	\$ 65.84
FST-CA-E-B-1/4-20x1/4	Bolt	1/4-20 x 1/4	\$ 44.80	FST-CA-M-B-8X50	Bolt	8 mm x 50 mm	\$ 70.62
FST-CA-E-B-1/4-20x3/8	Bolt	1/4-20 x 3/8	\$ 48.40	FST-CA-M-B-8X60	Bolt	8 mm x 60 mm	\$ 74.09
FST-CA-E-B-1/4-20x1/2	Bolt	1/4-20 x 1/2	\$ 53.40	FST-CA-M-B-8X75	Bolt	8 mm x 75 mm	\$ 78.71
FST-CA-E-B-1/4-20x3/4	Bolt	1/4-20 x 3/4	\$ 58.00				
FST-CA-E-B-1/4-20x1	Bolt	1/4-20 x 1	\$ 60.80				
FST-CA-E-B-1/4-20x1-1/4	Bolt	1/4-20 x 1-1/4	\$ 63.00				
FST-CA-E-B-1/4-20x1-1/2	Bolt	1/4-20 x 1-1/2	\$ 65.20				
FST-CA-E-B-1/4-20x1-3/4	Bolt	1/4-20 x 1-3/4	\$ 68.00				
FST-CA-E-B-1/4-20x2	Bolt	1/4-20 x 2	\$ 70.80				
FST-CA-E-B-1/4-20x2-1/2	Bolt	1/4-20 x 2-1/2	\$ 73.20				
FST-CA-E-B-1/4-20x3	Bolt	1/4-20 x 3	\$ 76.00				
FST-CA-E-B-5/16-18x1/4	Bolt	5/16-18 x 1/4	\$ 43.82				
FST-CA-E-B-5/16-18x3/8	Bolt	5/16-18 x 3/8	\$ 47.47				
FST-CA-E-B-5/16-18x1/2	Bolt	5/16-18 x 1/2	\$ 52.62				
FST-CA-E-B-5/16-18x3/4	Bolt	5/16-18 x 3/4	\$ 56.61				
FST-CA-E-B-5/16-18x1	Bolt	5/16-18 x 1	\$ 59.43				
FST-CA-E-B-5/16-18x1-1/4	Bolt	5/16-18 x 1-1/4	\$ 61.09				
FST-CA-E-B-5/16-18x1-1/2	Bolt	5/16-18 x 1-1/2	\$ 63.25				
FST-CA-E-B-5/16-18x1-3/4	Bolt	5/16-18 x 1-3/4	\$ 66.07				
FST-CA-E-B-5/16-18x2	Bolt	5/16-18 x 2	\$ 68.89				
FST-CA-E-B-5/16-18x2-1/2	Bolt	5/16-18 x 2-1/2	\$ 73.37				
FST-CA-E-B-5/16-18x3	Bolt	5/16-18 x 3	\$ 76.69				
FST-CA-E-B-3/8-16x1/4	Bolt	3/8-16 x 1/4	\$ 46.15				
FST-CA-E-B-3/8-16x3/8	Bolt	3/8-16 x 3/8	\$ 49.80				
FST-CA-E-B-3/8-16x1/2	Bolt	3/8-16 x 1/2	\$ 54.95				
FST-CA-E-B-3/8-16x3/4	Bolt	3/8-16 x 3/4	\$ 59.26				
FST-CA-E-B-3/8-16x1	Bolt	3/8-16 x 1	\$ 61.42				
FST-CA-E-B-3/8-16x1-1/4	Bolt	3/8-16 x 1-1/4	\$ 63.58				
FST-CA-E-B-3/8-16x1-1/2	Bolt	3/8-16 x 1-1/2	\$ 66.23				
FST-CA-E-B-3/8-16x1-3/4	Bolt	3/8-16 x 1-3/4	\$ 68.56				
FST-CA-E-B-3/8-16x2	Bolt	3/8-16 x 2	\$ 71.21				
FST-CA-E-B-3/8-16x2-1/2	Bolt	3/8-16 x 2-1/2	\$ 75.20				
FST-CA-E-B-3/8-16x3	Bolt	3/8-16 x 3	\$ 79.35				

Strength - Alumina (A998)	
Bolt Size	Destructive Torque (in*lb) <sup>1</sup>
4-40	1.6
6-32	2.3
8-32	5.5
10-32	6.2
1/4-20	20.4
5/16-18	41.9
3/8-16	95

**Strength Notes**  
 1. The data in the table is not guaranteed and intended only as informational. Exposing ceramic fasteners to the same forces typically exerted on metal fasteners is not recommended and may result in catastrophic failure.  
 2. "Destructive Torque" is the average maximum torque on hex head bolts until failure.

<b>CerMax™ High Temperature Non Conductive Ceramic Fasteners - Zirconia</b>							
<b>English (Other Sizes Available – Please Ask)</b>				<b>Metric (Other Sizes Available – Please Ask)</b>			
<b>Part Number</b>	<b>Type</b>	<b>Size</b>	<b>Price</b>	<b>Part Number</b>	<b>Type</b>	<b>Size</b>	<b>Price</b>
FST-CZ-E-B-2-56x1/4	Bolt	2-56 x 1/4	\$ 50.98	FST-CZ-M-B-2X5	Bolt	2 mm x 5 mm	\$ 48.51
FST-CZ-E-B-4-40x1/4	Bolt	4-40 x 1/4	\$ 53.96	FST-CZ-M-B-2X10	Bolt	2 mm x 10 mm	\$ 49.83
FST-CZ-E-B-4-40x3/8	Bolt	4-40 x 3/8	\$ 55.28	FST-CZ-M-B-3X5	Bolt	3 mm x 5 mm	\$ 50.98
FST-CZ-E-B-4-40x1/2	Bolt	4-40 x 1/2	\$ 58.41	FST-CZ-M-B-3X10	Bolt	3 mm x 10 mm	\$ 53.30
FST-CZ-E-B-4-40x3/4	Bolt	4-40 x 3/4	\$ 64.19	FST-CZ-M-B-3X15	Bolt	3 mm x 15 mm	\$ 56.10
FST-CZ-E-B-4-40x1	Bolt	4-40 x 1	\$ 73.76	FST-CZ-M-B-3X20	Bolt	3 mm x 20 mm	\$ 61.55
FST-CZ-E-B-6-32x1/4	Bolt	6-32 x 1/4	\$ 60.22	FST-CZ-M-B-3X25	Bolt	3 mm x 25 mm	\$ 70.62
FST-CZ-E-B-6-32x3/8	Bolt	6-32 x 3/8	\$ 61.38	FST-CZ-M-B-4X5	Bolt	4 mm x 5 mm	\$ 56.93
FST-CZ-E-B-6-32x1/2	Bolt	6-32 x 1/2	\$ 65.34	FST-CZ-M-B-4X10	Bolt	4 mm x 10 mm	\$ 59.24
FST-CZ-E-B-6-32x3/4	Bolt	6-32 x 3/4	\$ 71.78	FST-CZ-M-B-4X15	Bolt	4 mm x 15 mm	\$ 62.87
FST-CZ-E-B-6-32x1	Bolt	6-32 x 1	\$ 80.52	FST-CZ-M-B-4X20	Bolt	4 mm x 20 mm	\$ 69.14
FST-CZ-E-B-8-32x1/4	Bolt	8-32 x 1/4	\$ 65.01	FST-CZ-M-B-4X25	Bolt	4 mm x 25 mm	\$ 78.54
FST-CZ-E-B-8-32x3/8	Bolt	8-32 x 3/8	\$ 67.32	FST-CZ-M-B-4X30	Bolt	4 mm x 30 mm	\$ 85.31
FST-CZ-E-B-8-32x1/2	Bolt	8-32 x 1/2	\$ 70.46	FST-CZ-M-B-5X5	Bolt	5 mm x 5 mm	\$ 64.19
FST-CZ-E-B-8-32x3/4	Bolt	8-32 x 3/4	\$ 77.39	FST-CZ-M-B-5X10	Bolt	5 mm x 10 mm	\$ 66.50
FST-CZ-E-B-8-32x1	Bolt	8-32 x 1	\$ 87.29	FST-CZ-M-B-5X15	Bolt	5 mm x 15 mm	\$ 70.62
FST-CZ-E-B-8-32x1-1/4	Bolt	8-32 x 1-1/4	\$ 93.39	FST-CZ-M-B-5X20	Bolt	5 mm x 20 mm	\$ 76.40
FST-CZ-E-B-10-32x1/4	Bolt	10-32 x 1/4	\$ 70.46	FST-CZ-M-B-5X25	Bolt	5 mm x 25 mm	\$ 86.13
FST-CZ-E-B-10-32x3/8	Bolt	10-32 x 3/8	\$ 73.26	FST-CZ-M-B-5X30	Bolt	5 mm x 30 mm	\$ 92.57
FST-CZ-E-B-10-32x1/2	Bolt	10-32 x 1/2	\$ 76.89	FST-CZ-M-B-5X40	Bolt	5 mm x 40 mm	\$ 102.96
FST-CZ-E-B-10-32x3/4	Bolt	10-32 x 3/4	\$ 84.65	FST-CZ-M-B-6X5	Bolt	6 mm x 5 mm	\$ 68.48
FST-CZ-E-B-10-32x1	Bolt	10-32 x 1	\$ 95.54	FST-CZ-M-B-6X10	Bolt	6 mm x 10 mm	\$ 71.45
FST-CZ-E-B-10-32x1-1/4	Bolt	10-32 x 1-1/4	\$ 101.97	FST-CZ-M-B-6X15	Bolt	6 mm x 15 mm	\$ 75.57
FST-CZ-E-B-10-32x1-1/2	Bolt	10-32 x 1-1/2	\$ 107.09	FST-CZ-M-B-6X20	Bolt	6 mm x 20 mm	\$ 82.34
FST-CZ-E-B-1/4-20x1/4	Bolt	1/4-20 x 1/4	\$ 74.25	FST-CZ-M-B-6X25	Bolt	6 mm x 25 mm	\$ 92.89
FST-CZ-E-B-1/4-20x3/8	Bolt	1/4-20 x 3/8	\$ 76.89	FST-CZ-M-B-6X30	Bolt	6 mm x 30 mm	\$ 99.83
FST-CZ-E-B-1/4-20x1/2	Bolt	1/4-20 x 1/2	\$ 81.02	FST-CZ-M-B-6X40	Bolt	6 mm x 40 mm	\$ 110.06
FST-CZ-E-B-1/4-20x3/4	Bolt	1/4-20 x 3/4	\$ 88.44	FST-CZ-M-B-6X50	Bolt	6 mm x 50 mm	\$ 120.12
FST-CZ-E-B-1/4-20x1	Bolt	1/4-20 x 1	\$ 101.48				
FST-CZ-E-B-1/4-20x1-1/4	Bolt	1/4-20 x 1-1/4	\$ 107.25				
FST-CZ-E-B-1/4-20x1-1/2	Bolt	1/4-20 x 1-1/2	\$ 112.37				
FST-CZ-E-B-1/4-20x1-3/4	Bolt	1/4-20 x 1-3/4	\$ 119.79				
FST-CZ-E-B-1/4-20x2	Bolt	1/4-20 x 2	\$ 126.23				

### Material Properties – Alumina (A998) & Zirconia (TZP)

<b>Property</b>	<b>Unit</b>	<b>A998</b>	<b>TZP</b>
<b>Physical Properties</b>			
Composition (1)	weight %	99.8 AL <sub>2</sub> O <sub>3</sub>	5.4 Y <sub>2</sub> O <sub>3</sub>
Density (2)	g/cm <sup>3</sup>	3.89	6.0
Porosity	volume %	Impervious	Impervious
Color		Ivory	Off-white
<b>Mechanical Properties</b>			
Hardness	GPa (knoop)	11.1	11.7
4-point Bend (3) Strength (MOR)	MPa (ksi)	325 (47)	600 (87)
<b>Thermal Properties</b>			
Maximum Service Temp	°C	1650	2200
Thermal Expansion Coefficient	°C <sup>-1</sup> (25 – 700°C)	7.5 x 10 <sup>-6</sup>	11.2 x 10 <sup>-6</sup>
Thermal Conductivity (20°C)	W/m•°K (Btu•in/ft <sup>2</sup> •hr•°F)	35 (242)	2 (14)
<b>Electrical Properties</b>			
Dielectric Strength	Volts/mil	200	51
Dielectric Constant	@1MHz @ 20°C	10.0	28.0
	Ohm.cm @ 25°C	14	>10 <sup>13</sup>
Volume Resistivity	Ohm.cm @ 300°C	2.5x10 <sup>11</sup>	n/a
	Ohm.cm @ 500°C	5.5x10 <sup>10</sup>	4.8x10 <sup>3</sup>

1. Controlled by the Batch Composition

2. Measured by Pycnometer Immersion Technique

3. per ASTM C 1161-02c

### Zirconia (Zirconium Oxide, ZrO<sub>2</sub>)

Zirconia is one of the most studied ceramic materials. Zirconium dioxide (in its most naturally occurring form) is the mineral baddeleyite. Zirconia begins its life following a thermal treatment process (calcining) of the zirconium dioxide. This zirconia is further processed into different forms, including powder. Zirconia formulations utilize a "ready to press" type of zirconia powder for its near-net shaping manufacturing process.

#### Transformation Toughened

With a melting point of 2715°C and a boiling point of 4300°C, pure zirconia is extremely tough. However, when heated, phase changes in its physical characteristics reveal a weakness. In its tetragonal phase the expansion of a pure zirconia part results in internal stresses, leading to cracks. This inherent weakness is corrected with the addition of a stabilizer, such as yttria (Yttrium oxide, Y<sub>2</sub>O<sub>3</sub>), producing YTZP, a yttria partially stabilized zirconia.

A part made of YTZP zirconia remains stable as it moves from its monoclinic (room temperature) phase to its tetragonal (heated) phase and back again, resulting in lessened expansion, and minimal crack propagation. These changes are referred to as Transformation Toughening.

The common threads found making YTZP zirconia the material of choice often includes:

- Resistance to high abrasion
- Chemical stability
- Coefficient of thermal expansion similar to steel

Environments in which YTZP may not be suitable include long term water immersion and temperatures of 500° C (and above) in which electrical conductivity must be avoided. As with all custom ceramic part orders, we work closely with the customer to arrive at a ceramic formulation that not only meets the spec, but also avoids such undesirable circumstances.

### Alumina (Aluminum Oxide, Al<sub>2</sub>O<sub>3</sub>)

Alumina, one of the oldest technical ceramics, remains one of the most common still in use. Alumina, thoroughly documented since the 1920's, is an industry standard to which many other ceramic materials are compared. Many of the custom ceramic parts Ceramco manufactures for its customers are made from alumina because of its desirable properties, including:

- Chemical inertness
- Resistance to high wear
- Resistance to thermal conductivity
- Resistance to electrical conductivity

Alumina's most notable characteristics are its high hardness, dielectric constant and high mechanical stability. These characteristics make alumina ideal for customer applications subject to high wear and/or low electric loss.

### Stock Sizes Notes - alumina & zirconia (PSZ) fasteners

1. The pitch diameter of male threads will not exceed the max allowable according to Class 2. Minimum allowable pitch diameter may be below that of Class 2, conversely for female threads. Due to shrink factor variances, the stack up tolerance cannot be controlled on the pitch. It is recommended that you not engage more than 5 to 10 threads on any male fastener.

2. No warranty with respect to torque strength and tensile strength is extended or implied. Ceramic materials are inherently brittle and display catastrophic failure if impacted or stressed beyond material limits.

#### Head Styles:

- Socket Head
- Eye-bolt Head
- Hex Head
- Flat Head - Slotted, Phillips & Socket
- Pan Head - Slotted & Phillips



## CerMax™ Dense Machinable Glass-Ceramic



- Machinable Dense Glass-Ceramics
- High Temperature & High Voltage use
- Readily Machined, no firing required
- Thermal Shock Resistance
- High Dielectric & Mechanical Strength

### CerMax™ High Temperature Glass-Ceramic Machinable Forms

	MC-GC-P-L	MC-GC-P-H
Max Operating Temp	750°F / 400°C	1100°F / 593°C
Hardness	5.5	5.0
Specific Gravity g/cc	3.0	2.8
Density, lbs/in <sup>3</sup>	.11	.10
Porosity, %	Nil	Nil
Thermal Expansion in/in/°F x 10 <sup>-6</sup>	6.0 (10.8 for °C)	5.2 (9.5 for °C)
Compressive Strength, psi	45,000	32,000
Flexural Strength, psi	13,000	14,000
Dielectric Strength, v/mil	730	380
Loss Factor at 1 MHz	.009	.012
Dielectric Constant at 1 MHz	6.7	6.8
Thermal Conductivity, BTUx in/hrxft <sup>2</sup> x°F ( W/mx°K)	6.02 (.87)	4.08 (.59)

#### 750°F/400°C Glass-Ceramic

Part Number	Type	Size (inches)	Price
MC-GC-P-L-1/4-4-6	Plate	¼ x 4 x 6	\$ 150.00
MC-GC-P-L-1/4-14-20	Plate	¼ x 14 x 20	\$ 760.00
MC-GC-P-L-3/8-4-6	Plate	3/8 x 4 x 6	\$ 170.00
MC-GC-P-L-3/8-14-20	Plate	3/8 x 14 x 20	\$ 840.00
MC-GC-P-L-1/2-4-6	Plate	½ x 4 x 6	\$ 200.00
MC-GC-P-L -1/2-14-20	Plate	½ x 14 x 20	\$ 970.00
MC-GC-P-L -3/4-4-6	Plate	¾ x 4 x 6	\$ 250.00
MC-GC-P-L -3/4-14-20	Plate	¾ x 14 x 20	\$ 1260.00
MC-GC-P-L -1-4-6	Plate	1 x 4 x 6	\$ 320.00
MC-GC-P-L -1-14-20	Plate	1 x 14 x 20	\$ 1590.00
MC-GC-R-L -1/4-12	Rod	¼ x 12	\$ 170.00
MC-GC-R-L -1/2-12	Rod	½ x 12	\$ 200.00
MC-GC-R-L -3/4-12	Rod	¾ x 12	\$ 260.00
MC-GC-R-L -1-12	Rod	1 x 12	\$ 330.00

#### 1100°F / 593°C Glass-Ceramic

Part Number	Type	Size (inches)	Price
MC-GC-P-H-1/4-4-6	Plate	¼ x 4 x 6	\$ 220.00
MC-GC-P-H-1/4-14-20	Plate	¼ x 14 x 20	\$ 1560.00
MC-GC-P-H-3/8-4-6	Plate	3/8 x 4 x 6	\$ 244.00
MC-GC-P-H-3/8-14-20	Plate	3/8 x 14 x 20	\$1730.00
MC-GC-P-H-1/2-4-6	Plate	½ x 4 x 6	\$ 274.00
MC-GC-P-H -1/2-14-20	Plate	½ x 14 x 20	\$ 1940.00
MC-GC-P-H -3/4-4-6	Plate	¾ x 4 x 6	\$ 396.00
MC-GC-P-H -3/4-14-20	Plate	¾ x 14 x 20	\$ 2810.00
MC-GC-P-H -1-4-6	Plate	1 x 4 x 6	\$ 588.00
MC-GC-P-H -1-14-20	Plate	1 x 14 x 20	\$ 4170.00
MC-GC-R-H -1/4-12	Rod	¼ x 12	\$ 200.00
MC-GC-R-H -1/2-12	Rod	½ x 12	\$ 260.00
MC-GC-R-H -3/4-12	Rod	¾ x 12	\$ 290.00
MC-GC-R-H -1-12	Rod	1 x 12	\$ 600.00

## CerMax™ Dense Machinable Unfired Aluminum Silicate



- Machinable Dense Glass-Ceramics
- High Temperature & High Voltage use
- Readily Machined, no firing required
- Thermal Shock Resistance
- High Dielectric & Mechanical Strength

### CerMax™ High Temperature Glass-Ceramic Machinable Forms

	MC-GC-P-L	MC-GC-P-H
Max Operating Temp	750°F / 400°C	1100°F / 593°C
Hardness	5.5	5.0
Specific Gravity g/cc	3.0	2.8
Density, lbs/in <sup>2</sup>	.11	.10
Porosity, %	Nil	Nil
Thermal Expansion in/in/°F x 10 <sup>-6</sup>	6.0 (10.8 for °C)	5.2 (9.5 for °C)
Compressive Strength, psi	45,000	32,000
Flexural Strength, psi	13,000	14,000
Dielectric Strength, v/mil	730	380
Loss Factor at 1 MHz	.009	.012
Dielectric Constant at 1 MHz	6.7	6.8
Thermal Conductivity, BTUx in/hrxft <sup>2</sup> x°F ( W/mx°K)	6.02 (.87)	4.08 (.59)

#### 750°F/400°C Glass-Ceramic

Part Number	Type	Size (inches)	Price
MC-AS-P-L-1/4-4-6	Plate	¼ x 4 x 6	\$ 150.00
MC-AS-P-L-1/4-14-20	Plate	¼ x 14 x 20	\$ 760.00
MC-AS-P-L-3/8-4-6	Plate	3/8 x 4 x 6	\$ 170.00
MC-AS-P-L-3/8-14-20	Plate	3/8 x 14 x 20	\$ 840.00
MC-AS-P-L-1/2-4-6	Plate	½ x 4 x 6	\$ 200.00
MC-AS-P-L-1/2-14-20	Plate	½ x 14 x 20	\$ 970.00
MC-AS-P-L-3/4-4-6	Plate	¾ x 4 x 6	\$ 250.00
MC-AS-P-L-3/4-14-20	Plate	¾ x 14 x 20	\$ 1260.00
MC-AS-P-L-1-4-6	Plate	1 x 4 x 6	\$ 320.00
MC-AS-P-L-1-14-20	Plate	1 x 14 x 20	\$ 1590.00
MC-AS-R-L-1/4-12	Rod	¼ x 12	\$ 170.00
MC-AS-R-L-1/2-12	Rod	½ x 12	\$ 200.00
MC-AS-R-L-3/4-12	Rod	¾ x 12	\$ 260.00
MC-AS-R-L-1-12	Rod	1 x 12	\$ 330.00

## CerMax™ High Temperature Round Flat Bottom Crucibles



- Alumina & Magnesium Oxide Crucibles
- Full Fired
- Inert to Molten Metals & Slags
- Thermal Shock Resistance
- High Dielectric & Mechanical Strength

CerMax™ Round Crucibles – Magnesium Oxide / Alumina					
Max Operating Temp	Magnesium Oxide		Alumina		
Hardness	3270°F / 1800°C		3000°F / 1649°C		
Specific Gravity g/cc	5.5		9.0		
Density, lbs/in <sup>2</sup>	3.45		3.9		
Porosity, %	.12		.134		
Thermal Expansion in/in/°F x 10 <sup>-6</sup>	4.5		Nil		
Compressive Strength, psi	7.7 (13.9 for °C)		3.5 (6.3 for °C)		
Flexural Strength, psi	120,000		340,000		
Dielectric Strength, v/mil	35,000		46,000		
Loss Factor at 1 MHz	150		225		
Dielectric Constant at 1 MHz	-		.0018		
Thermal Conductivity, BTUx in/hrxft <sup>2</sup> x°F ( W/mx°K)	9.6		9.3		
	15.0 (2.2)		220 (31.7)		
Round Flat Bottom Crucibles					
For "X" In the part number: use "M" for Magnesium Oxide use "A" for Alumina					
Part Number	OD		Length		Price
CC-FB-X-10010	1.00	25.40	1.00	25.40	\$ 68.00
CC-FB-X-10012	1.00	25.40	1.25	31.75	\$ 74.00
CC-FB-X-12512	1.25	31.75	1.25	31.75	\$ 92.00
CC-FB-X-12525	1.25	31.75	2.50	63.50	\$ 130.00
CC-FB-X-15020	1.50	38.10	2.00	50.80	\$ 132.00
CC-FB-X-15030	1.50	38.10	3.00	76.20	\$ 166.00
CC-FB-X-17525	1.75	44.45	2.50	63.50	\$ 168.00
CC-FB-X-17535	1.75	44.45	3.50	88.90	\$ 206.00
CC-FB-X-20020	2.00	50.80	2.00	50.80	\$ 166.00
CC-FB-X-20035	2.00	50.80	3.50	88.90	\$ 230.00
CC-FB-X-20050	2.00	50.80	5.00	127.00	\$ 290.00
CC-FB-X-20060	2.00	50.80	6.00	152.40	\$ 328.00
CC-FB-X-22535	2.25	57.15	3.50	88.90	\$ 254.00
CC-FB-X-25030	2.50	63.50	3.00	76.20	\$ 252.00
CC-FB-X-25055	2.50	63.50	5.50	139.70	\$ 372.00
CC-FB-X-30030	3.00	76.20	3.00	76.20	\$ 330.00
CC-FB-X-30040	3.00	76.20	4.00	101.60	\$ 394.00
CC-FB-X-30045	3.00	76.20	4.50	114.30	\$ 426.00
CC-FB-X-30057	3.00	76.20	5.75	146.05	\$ 502.00
CC-FB-X-35050	3.50	88.90	5.00	127.00	\$ 526.00
CC-FB-X-35060	3.50	88.90	6.00	152.40	\$ 594.00
CC-FB-X-40040	4.00	101.60	4.00	101.60	\$ 514.00
CC-FB-X-40060	4.00	101.60	6.00	152.40	\$ 670.00
CC-FB-X-45045	4.50	114.30	4.50	114.30	\$ 620.00
CC-FB-X-45060	4.50	114.30	6.00	152.40	\$ 746.00
CC-FB-X-50050	5.00	127.00	5.00	127.00	\$ 732.00
CC-FB-X-50080	5.00	127.00	8.00	203.20	\$ 1000.00
CC-FB-X-55055	5.50	139.70	5.50	139.70	\$ 852.00
CC-FB-X-60060	6.00	152.40	6.00	152.40	\$ 1084.00
CC -FB-X-600X0	6.00	152.40	10.00	254.00	\$ 1530.00



**Thermal, EMI/RFI & Abrasion Protection Materials**

Fax Orders: 610-340-9054 Telephone Orders: 610-906-3549 [orders@abthermal.com](mailto:orders@abthermal.com)

---

---



**Thermal, EMI/RFI & Abrasion Protection Materials**

Fax Orders: 610-340-9054 Telephone Orders: 610-906-3549 [orders@abthermal.com](mailto:orders@abthermal.com)

---





**High Temperature, Heat, Flame, Fire, Molten Metal & Weld Splatter Protection Materials**

*Fax Orders: 610-340-9054 Telephone Orders: 610-906-3549 orders@abthermal.com*

---

---



# Silicone Rubber Products

Silicone Rubber Tubing, Industrial Grade – Oxide-Red .....	9-1
Silicone Rubber Tubing, Industrial Grade – Natural / Clear .....	9-4
Silicone Rubber Tubing, FDA Food/Medical Grade; small diameter .....	9-5
Silicone Rubber Tubing, FDA Food/Medical Grade; large diameter .....	9-6
Silicone Rubber Star Tubing .....	9-7
Silicone Rubber Caps and Plugs .....	9-8
Silicone Rubber Adhesives, Sealants, End-Seal Dip, Paint, Ink .....	9-15
Silicone Rubber Adhesive & Sealant for Commercial Kitchen Use .....	9-16
Semi-Cured Silicone Rubber Bulk Compound .....	9-17
Silicone Rubber Extruded Profiles .....	9-18
Silicone Rubber Electrical Strip Heaters .....	9-19
Drum & Pail Heaters .....	9-21
Stranded Tinned Copper Wire with Silicone Rubber Jacket .....	9-24
Sil-Ink™ High Temperature Ink for Printing on Silicone Rubber (Primary) – EPDM, EPR (Secondary) .....	9-25



Silicone Rubber Tubing  
Page 9-1 – 9-5



Silicone Rubber Plugs  
Page 9-6 – 9-10



Silicone End-Seal Dip,  
Paint & Ink  
Page 9-11



Silicone Adhesive/Sealant  
Page 9-11



Silicone Rubber Extruded  
Profile Shapes Page 9-12

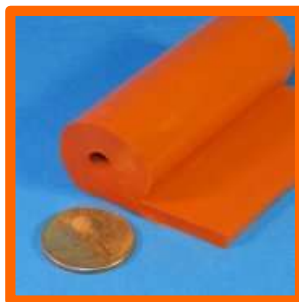

Silicone Rubber Extruded  
Gasket & Seal Shapes  
Page 9-12



Silicone Flexible Strip  
Heaters Page 9-13

## Silicone Rubber Tubing; High Temperature & Heat Resistant 460°F / 237°C: Premium Grade – Oxide-Red Color



Variety of uses including air, gas and liquid transfer.

Can be used to mask threads and posts for powder coating painting applications.

Good elasticity to fit over pipe nipples.

Weld splatter, grinding spark and molten metal splash protection.

Hardness: 50 +/-5, Tensile: >1000 psi,  
Elongation: >400%, Tear Strength: >100 lbs/in,  
Specific Gravity: <1.7, Electrical Resistance: 24kV/mm,  
Electrical Volume Resistivity: 1 x 10 ohm/cm



**Silicone Rubber Tubing; High Temperature & Heat Resistant (Continued)**  
**460°F / 237°C: Premium Grade – Oxide-Red Color**

<b>High Temperature, Heat &amp; Flame Resistant Silicone Rubber Tubing Premium Grade – Oxide-Red Color</b>				
Part Number	Inside Diameter in / mm	Wall Thickness in / mm	Coiled Length ft / m	Price per Coil
SR-TUBE-RED-104-W04-10	.104 / 2.60	.040 / 1.00	100 / 30.48	\$ 152.67
SR-TUBE-RED-110-W04-10	.110 / 2.80	.040 / 1.00	100 / 30.48	\$ 156.70
SR-TUBE-RED-130-W04-10	.130 / 3.30	.040 / 1.00	100 / 30.48	\$ 161.00
SR-TUBE-RED-149-W04-10	.149 / 3.80	.040 / 1.00	100 / 30.48	\$ 164.33
SR-TUBE-RED-163-W04-10	.163 / 4.10	.040 / 1.00	100 / 30.48	\$ 171.67
SR-TUBE-RED-181-W04-10	.181 / 4.60	.040 / 1.00	100 / 30.48	\$ 183.67
SR-TUBE-RED-224-W04-10	.224 / 5.70	.040 / 1.00	100 / 30.48	\$ 194.67
SR-TUBE-RED-239-W04-10	.239 / 6.10	.040 / 1.00	100 / 30.48	\$ 202.00
SR-TUBE-RED-302-W06-15	.302 / 7.70	.060 / 1.50	100 / 30.48	\$ 229.00
SR-TUBE-RED-330-W06-15	.330 / 8.40	.060 / 1.50	100 / 30.48	\$ 240.33
SR-TUBE-RED-363-W06-15	.363 / 9.20	.060 / 1.50	100 / 30.48	\$ 244.33
SR-TUBE-RED-375-W06-15	.375 / 9.53	.060 / 1.50	100 / 30.48	\$ 249.69
SR-TUBE-RED-380-W06-15	.380 / 9.70	.060 / 1.50	100 / 30.48	\$ 252.13
SR-TUBE-RED-406-W06-15	.406 / 10.31	.060 / 1.50	100 / 30.48	\$ 260.48
SR-TUBE-RED-420-W06-15	.420 / 10.60	.060 / 1.50	100 / 30.48	\$ 266.67
SR-TUBE-RED-437-W06-15	.437 / 11.10	.060 / 1.50	100 / 30.48	\$ 278.83
SR-TUBE-RED-460-W06-15	.460 / 11.70	.060 / 1.50	100 / 30.48	\$ 282.33
SR-TUBE-RED-485-W06-15	.485 / 12.30	.060 / 1.50	50 / 15.24	\$ 143.67
SR-TUBE-RED-500-W06-15	.500 / 12.70	.060 / 1.50	50 / 15.24	\$ 166.91
SR-TUBE-RED-535-W06-15	.535 / 13.60	.060 / 1.50	50 / 15.24	\$ 183.67
SR-TUBE-RED-609-W06-15	.609 / 15.50	.060 / 1.50	50 / 15.24	\$ 207.03
SR-TUBE-RED-625-W06-15	.625 / 15.88	.060 / 1.50	50 / 15.24	\$ 222.62
SR-TUBE-RED-727-W06-15	.727 / 18.50	.060 / 1.50	50 / 15.24	\$ 236.67
SR-TUBE-RED-750-W06-15	.750 / 19.05	.060 / 1.50	50 / 15.24	\$ 281.48
SR-TUBE-RED-853-W06-15	.853 / 21.67	.060 / 1.50	50 / 15.24	\$ 366.67
SR-TUBE-RED-875-W06-15	.875 / 22.23	.060 / 1.50	50 / 15.24	\$ 373.81
SR-TUBE-RED-915-W06-15	.915 / 23.34	.060 / 1.50	50 / 15.24	\$ 381.33
SR-TUBE-RED-937-W06-15	.937 / 23.80	.060 / 1.50	50 / 15.24	\$ 390.64
SR-TUBE-RED-975-W06-15	.975 / 24.77	.060 / 1.50	50 / 15.24	\$ 400.35

**This Product is NOT Available By-The-Foot – Full Coil Quantity Only**



**Silicone Rubber Tubing; High Temperature & Heat Resistant (Continued)**  
460°F / 237°C: Premium Grade – Oxide-Red Color

<b>High Temperature, Heat &amp; Flame Resistant Silicone Rubber Tubing Industrial – Oxide-Red Color – Large Diameter</b>				
<b>Part Number</b>	<b>Inside Diameter in / mm</b>	<b>Wall Thickness in / mm</b>	<b>Coiled Length ft / m</b>	<b>Price per Coil</b>
SR-TUBE-RED-1000-W06-15	1.000 / 25.40	.060 / 1.50	100 / 30.48	\$ 347.87
SR-TUBE-RED-1125-W06-15	1.125 / 28.58	.060 / 1.50	100 / 30.48	\$ 375.71
SR-TUBE-RED-1250-W06-15	1.250 / 31.75	.060 / 1.50	100 / 30.48	\$ 417.33
SR-TUBE-RED-1375-W06-15	1.375 / 34.93	.060 / 1.50	100 / 30.48	\$ 486.97
SR-TUBE-RED-1500-W06-15	1.500 / 38.10	.060 / 1.50	100 / 30.48	\$ 556.40
SR-TUBE-RED-1625-W06-15	1.625 / 41.28	.060 / 1.50	100 / 30.48	\$ 584.67
SR-TUBE-RED-1750-W06-15	1.750 / 44.45	.060 / 1.50	100 / 30.48	\$ 626.11
SR-TUBE-RED-1875-W06-15	1.875 / 47.63	.060 / 1.50	100 / 30.48	\$ 751.15
SR-TUBE-RED-2000-W06-15	2.000 / 50.80	.060 / 1.50	100 / 30.48	\$ 797.47

**This Product is NOT Available By-The-Foot – Full Coil Quantity Only**

These silicone rubber products provide excellent cold temperature performance with flexibility to -76°C for refrigeration and cryogenic applications.

## Silicone Rubber Tubing; High Temperature & Heat Resistant 500°F / 260°C: Premium Grade – Natural / Translucent



Variety of uses including air, gas and liquid transfer.

Can be used to mask threads and posts for powder coating painting applications.

Good elasticity to fit over pipe nipples.

Hardness: 50 +/-5, Tensile: >1000 psi,  
Elongation: >400%, Tear Strength: >100 lbs/in,  
Specific Gravity: <1.7, Electrical Resistance: 24kV/mm,  
Electrical Volume Resistivity: 1 x 10 ohm/cm

500°F / 260°C continuous rating

High Temperature, Heat & Flame Resistant Silicone Rubber Tubing Premium Natural / Clear				
Part Number	Inside Diameter in / mm	Wall Thickness in / mm	Coiled Length ft / m	Price per Coil
SR-TUBE-NAT-ID040-W06-15	.040 / 1.02	.060 / 1.50	100 / 30.48	\$ 74.20
SR-TUBE-NAT-ID062-W06-15	.062 / 1.57	.060 / 1.50	100 / 30.48	\$ 78.64
SR-TUBE-NAT-ID080-W06-15	.080 / 2.03	.060 / 1.50	100 / 30.48	\$ 81.80
SR-TUBE-NAT-ID093-W06-15	.093 / 2.36	.060 / 1.50	100 / 30.48	\$ 85.63
SR-TUBE-NAT-ID109-W06-15	.109 / 2.77	.060 / 1.50	100 / 30.48	\$ 107.81
SR-TUBE-NAT-ID125-W06-15	.125 / 3.18	.060 / 1.50	100 / 30.48	\$ 111.26
SR-TUBE-NAT-ID140-W06-15	.140 / 3.56	.060 / 1.50	100 / 30.48	\$ 115.10
SR-TUBE-NAT-ID156-W06-15	.156 / 3.96	.060 / 1.50	100 / 30.48	\$ 118.36
SR-TUBE-NAT-ID172-W06-15	.172 / 4.37	.060 / 1.50	100 / 30.48	\$ 122.73
SR-TUBE-NAT-ID187-W06-15	.187 / 4.75	.060 / 1.50	100 / 30.48	\$ 131.67
SR-TUBE-NAT-ID203-W06-15	.203 / 5.16	.060 / 1.50	100 / 30.48	\$ 137.17
SR-TUBE-NAT-ID218-W06-15	.218 / 5.54	.060 / 1.50	100 / 30.48	\$ 144.90
SR-TUBE-NAT-ID234-W06-15	.234 / 5.94	.060 / 1.50	100 / 30.48	\$ 152.32
SR-TUBE-NAT-ID250-W06-15	.250 / 6.35	.060 / 1.50	100 / 30.48	\$ 159.80
SR-TUBE-NAT-ID281-W06-15	.281 / 7.14	.060 / 1.50	100 / 30.48	\$ 174.67
SR-TUBE-NAT-ID312-W06-15	.312 / 7.92	.060 / 1.50	100 / 30.48	\$ 189.22

**This Product is NOT Available By-The-Foot – Full Coil Quantity Only**

These silicone rubber products provide excellent cold temperature performance with flexibility to -76°C for refrigeration and cryogenic applications.

## Silicone Rubber Tubing: Food & Medical Grade High Temperature & Heat Resistant: Premium Grade - ID 1/32" to 5/16"



Custom extruded - delivery may be up to 4 weeks.  
Available in Natural translucent or red.

Conforms to FDA 21 CFR 177-2600.

Meets A-A-59588 (MIL-ZZ-R-765E Class 2A, Grade 50).  
Meets SAE-AMS-3302.

Meets ASTM D2000  
M5GE506A19B37EA14E016E036F19G11

Tolerance is to ISO 3302-1 Class E2.

400°F / 204°C continuous rating with weld splatter, spark, molten metal splash protection  
450°F / 232°C intermittent. Short use to 480°F / 250°C. Cold use to -60°F / -50°C

High Temperature, Heat & Flame Resistant Silicone Rubber Tubing				
Part Number	Inside Diameter frac / in / mm	Wall Thickness frac / in / mm	Coiled Length ft / m	Price per Coil
SR-PGT-ID031-W031-X	1/32 / .031 / 0.8	1/32 / .031 / 0.8	100 / 30.48	\$ Call
SR-PGT-ID063-W031-X	1/16 / .063 / 1.60	1/32 / .031 / 0.8	100 / 30.48	\$ Call
SR-PGT-ID063-W063-X	1/16 / .063 / 1.60	1/16 / .063 / 1.6	100 / 30.48	\$ Call
SR-PGT-ID094-W031-X	3/32 / .094 / 2.40	1/32 / .031 / 0.8	100 / 30.48	\$ Call
SR-PGT-ID094-W063-X	3/32 / .094 / 2.40	1/16 / .063 / 1.6	100 / 30.48	\$ Call
SR-PGT-ID125-W031-X	1/8 / .125 / 3.20	1/32 / .031 / 0.8	100 / 30.48	\$ Call
SR-PGT-ID125-W063-X	1/8 / .125 / 3.20	1/16 / .063 / 1.6	100 / 30.48	\$ Call
SR-PGT-ID125-W094-X	1/8 / .125 / 3.20	3/32 / .094 / 2.40	100 / 30.48	\$ Call
SR-PGT-ID125-W125-X	1/8 / .125 / 3.20	1/8 / .125 / 3.20	100 / 30.48	\$ Call
SR-PGT-ID188-W031-X	3/16 / .188 / 4.8	1/32 / .031 / 0.8	100 / 30.48	\$ Call
SR-PGT-ID188-W063-X	3/16 / .188 / 4.8	1/16 / .063 / 1.6	100 / 30.48	\$ Call
SR-PGT-ID188-W094-X	3/16 / .188 / 4.8	3/32 / .094 / 2.40	100 / 30.48	\$ Call
SR-PGT-ID188-W125-X	3/16 / .188 / 4.8	1/8 / .125 / 3.20	100 / 30.48	\$ Call
SR-PGT-ID188-W188-X	3/16 / .188 / 4.8	3/16 / .188 / 4.80	100 / 30.48	\$ Call
SR-PGT-ID250-W031-X	¼ / .250 / 6.4	1/32 / .031 / 0.8	100 / 30.48	\$ Call
SR-PGT-ID250-W063-X	¼ / .250 / 6.4	1/16 / .063 / 1.6	100 / 30.48	\$ Call
SR-PGT-ID250-W094-X	¼ / .250 / 6.4	3/32 / .094 / 2.40	100 / 30.48	\$ Call
SR-PGT-ID250-W125-X	¼ / .250 / 6.4	1/8 / .125 / 3.20	100 / 30.48	\$ Call
SR-PGT-ID313-W031-X	5/16 / .313 / 8.0	1/32 / .031 / 0.8	100 / 30.48	\$ Call
SR-PGT-ID313-W063-X	5/16 / .313 / 8.0	1/16 / .063 / 1.6	100 / 30.48	\$ Call
SR-PGT-ID313-W094-X	5/16 / .313 / 8.0	3/32 / .094 / 2.40	100 / 30.48	\$ Call
SR-PGT-ID313-W125-X	5/16 / .313 / 8.0	1/8 / .125 / 3.20	100 / 30.48	\$ Call

**Minimum Order Quantity is 200 Feet**

**This Product is NOT Available By-The-Foot – Full Coil Quantity Only**

For the "X" value, Use "N" for natural and "R" for oxide-red

## Silicone Rubber Tubing: Food & Medical Grade High Temperature & Heat Resistant: Premium Grade - ID 3/8" to 1"



Custom extruded - delivery may be up to 4 weeks.  
Available in Natural translucent or red.

Conforms to FDA 21 CFR 177-2600.

Meets A-A-59588 (MIL-ZZ-R-765E Class 2A, Grade 50).  
Meets SAE-AMS-3302.

Meets ASTM D2000  
M5GE506A19B37EA14E016E036F19G11

Tolerance is to ISO 3302-1 Class E2.

400°F / 204°C continuous rating with weld splatter, spark, molten metal splash protection  
450°F / 232°C intermittent. Short use to 480°F / 250°C. Cold use to -60°F / -50°C

High Temperature, Heat & Flame Resistant Silicone Rubber Tubing				
Part Number	Inside Diameter frac / in / mm	Wall Thickness frac / in / mm	Coiled Length ft / m	Price per Coil
SR-PGT-ID375-W031-X	3/8 / .375 / 9.50	1/32 / .031 / 0.8	100 / 30.48	\$ Call
SR-PGT-ID375-W063-X	3/8 / .375 / 9.50	1/16 / .063 / 1.6	100 / 30.48	\$ Call
SR-PGT-ID375-W094-X	3/8 / .375 / 9.50	3/32 / .094 / 2.40	100 / 30.48	\$ Call
SR-PGT-ID375-W125-X	3/8 / .375 / 9.50	1/8 / .125 / 3.20	100 / 30.48	\$ Call
SR-PGT-ID375-W188-X	3/8 / .375 / 9.50	3/16 / .188 / 4.80	100 / 30.48	\$ Call
SR-PGT-ID438-W031-X	7/16 / .438 / 11.1	1/32 / .031 / 0.8	100 / 30.48	\$ Call
SR-PGT-ID438-W094-X	7/16 / .438 / 11.1	3/32 / .094 / 2.40	100 / 30.48	\$ Call
SR-PGT-ID500-W031-X	1/2 / .500 / 12.7	1/32 / .031 / 0.8	100 / 30.48	\$ Call
SR-PGT-ID500-W063-X	1/2 / .500 / 12.7	1/16 / .063 / 1.6	100 / 30.48	\$ Call
SR-PGT-ID500-W094-X	1/2 / .500 / 12.7	3/32 / .094 / 2.40	50 / 15.24	\$ Call
SR-PGT-ID500-W125-X	1/2 / .500 / 12.7	1/8 / .125 / 3.20	50 / 15.24	\$ Call
SR-PGT-ID500-W188-X	1/2 / .500 / 12.7	3/16 / .188 / 4.80	50 / 15.24	\$ Call
SR-PGT-ID625-W063-X	5/8 / .625 / 15.9	1/16 / .063 / 1.6	50 / 15.24	\$ Call
SR-PGT-ID625-W094-X	5/8 / .625 / 15.9	3/32 / .094 / 2.40	50 / 15.24	\$ Call
SR-PGT-ID625-W125-X	5/8 / .625 / 15.9	1/8 / .125 / 3.20	50 / 15.24	\$ Call
SR-PGT-ID625-W188-X	5/8 / .625 / 15.9	3/16 / .188 / 4.80	50 / 15.24	\$ Call
SR-PGT-ID750-W063-X	3/4 / .750 / 19.1	1/16 / .063 / 1.6	50 / 15.24	\$ Call
SR-PGT-ID750-W125-X	3/4 / .750 / 19.1	1/8 / .125 / 3.20	50 / 15.24	\$ Call
SR-PGT-ID750-W188-X	3/4 / .750 / 19.1	3/16 / .188 / 4.80	50 / 15.24	\$ Call
SR-PGT-ID1000-W031-X	1 / 1.000 / 25.4	1/32 / .031 / 0.8	50 / 15.24	\$ Call
SR-PGT-ID1000-W063-X	1 / 1.000 / 25.4	1/16 / .063 / 1.6	50 / 15.24	\$ Call
SR-PGT-ID1000-W125-X	1 / 1.000 / 25.4	1/8 / .125 / 3.20	50 / 15.24	\$ Call

**Minimum Order Quantity is full coil**

**This Product is NOT Available By-The-Foot – Full Coil Quantity Only**

For the "X" value (color code), Use "N" for natural or "R" for oxide-red



**Silicone Rubber Star Tubing**  
**High Temperature & Heat Resistant Suited for Powder Coating**  
**500°F / 260°C: Premium Grade**



- Star shaped tubing is easier to install and remove on studs and rods than round tubing as it has less contact area.
- Sizing assignment is easy to repeat without measuring due to unique colors for most sizes.
- Excellent elasticity.
- Can be used to mask threads and posts for powder coating.
- .062" wall thickness.

<b>High Temperature, Heat &amp; Flame Resistant Silicone Rubber Star Tubing</b>				
<b>Part Number</b>	<b>Minor ID in / mm</b>	<b>Major ID in / mm</b>	<b>Coiled Length ft / m</b>	<b>Price per Coil</b>
SR-STAR-0.200-WHITE	0.200 / 5.0	.250 / 6.3	100 / 30	\$ 192.00
SR-STAR-0.300-RUST	0.300 / 7.6	.375 / 9.5	100 / 30	\$ 216.00
SR-STAR-0.400-YELLOW	0.400 / 10.2	.500 / 12.7	100 / 30	\$ 285.00
SR-STAR-0.500-PURPLE	0.500 / 12.7	.625 / 15.9	100 / 30	\$ 381.00
SR-STAR-0.625-RUST	0.625 / 15.9	.750 / 19.0	50 / 15	\$ 237.00
SR-STAR-0.725-BLUE	0.725 / 18.4	.875 / 22.2	50 / 15	\$ 285.00
SR-STAR-0.850-WHITE	0.850 / 21.6	1.000 / 25.4	50 / 15	\$ 342.00
SR-STAR-1.000-CLEAR	1.000 / 25.4	1.250 / 31.7	25 / 7.6	\$ 228.75
SR-STAR-1.250-PURPLE	1.250 / 31.7	1.500 / 38.1	25 / 7.6	\$ 262.50
SR-STAR-1.500-RUST	1.500 / 38.1	1.750 / 44.4	25 / 7.6	\$ 285.00
SR-STAR-1.750-ORANGE	1.750 / 44.4	2.000 / 50.8	25 / 7.6	\$ 309.75

**This Product is NOT Available By-The-Foot – Full Coil Quantity Only**

These silicone rubber products provide excellent cold temperature performance with flexibility to -76°C for refrigeration and cryogenic applications.

## Silicone Rubber Tapered Plugs: High Temperature & Heat Resistant Small Sizes



- High Temperature natural color Silicone Rubber for use at 500°F / 260°C continuous and up to 600°F / 316°C intermittent short duration.
- Some sizes also available in EPDM (black) with a lower temperature range (425°F / 218°C).

High Temperature & Heat Resistant Silicone Rubber Tapered Plugs Small Size: 1.6mm x .4mm x 15.9mm to 12.7mm x 7.9mm x 25.4mm (Above dimension is Wide End x Small End x Length)						
Part Number	Large End Diameter in / mm	Small End Diameter in / mm	Length in / mm	Pack Quantity	Color	Price
SR-TP-1.6-0.4-15.9	.062 / 1.6	.016 / 0.4	.625 / 15.9	1000		\$ 62.20
SR-TP-2.0-0.5-19.1	.078 / 2.0	.020 / 0.5	.750 / 19.1	1000		\$ 70.67
SR-TP-2.03-.38-50.8-E	.080 / 2.03	.015 / 0.38	2.000 / 50.80	500	W	\$ 84.00
SR-TP-3.2-0.8-15.9	.125 / 3.2	.031 / 0.8	.625 / 15.9	1000		\$ 57.97
SR-TP-3.2-1.6-15.9	.125 / 3.2	.062 / 1.6	.625 / 15.9	1000		\$ 49.75
SR-TP-4.7-1.6-15.9	.187 / 4.7	.062 / 1.6	.625 / 15.9	1000		\$ 59.38
SR-TP-4.7-1.6-19.1-M*	.187 / 4.7	.062 / 1.6	.750 / 19.1	1000	OR	\$ 66.42
SR-TP-5.0-1.2-27.9	.197 / 5.0	.049 / 1.2	1.100 / 27.9	1000		\$ 85.53
SR-TP-5.1-1.6-19.1	.200 / 5.1	.062 / 1.6	0.750 / 19.1	1000		\$ 73.53
SR-TP-6.3-3.2-19.1	.250 / 6.3	.125 / 3.2	0.750 / 19.1	1000		\$ 86.23
SR-TP-6.3-3.2-25.4-M*	.250 / 6.3	.125 / 3.2	1.000 / 25.4	1000	OR	\$ 106.05
SR-TP-7.1-0.4-25.0	.279 / 7.1	.016 / 0.4	0.984 / 25.0	1000		\$ 275.67
SR-TP-8.7-4.7-15.9	.343 / 8.7	.187 / 4.7	0.625 / 15.9	1000		\$ 108.85
SR-TP-8.7-4.7-25.4-M*	.343 / 8.7	.187 / 4.7	1.000 / 25.4	1000	OR	\$ 141.37
SR-TP-9.5-3.2-31.8	.375 / 9.5	.125 / 3.2	1.250 / 31.8	1000		\$ 127.22
SR-TP-9.5-6.3-19.1	.375 / 9.5	.250 / 6.3	0.750 / 19.1	1000		\$ 175.30
SR-TP-11.1-6.3-25.4-M*	.437 / 11.1	.250 / 6.3	1.000 / 25.4	1000	OR	\$ 226.20
SR-TP-12.0-9.0-18.0	.472 / 12.0	.354 / 9.0	0.708 / 18.0	500		\$ 152.63
SR-TP-12.7-3.2-50.8	.500 / 12.7	.125 / 3.2	2.000 / 50.8	500		\$ 182.27
SR-TP-12.7-7.9-25.4	.500 / 12.7	.312 / 7.9	1.000 / 25.4	200		\$ 66.73
SR-TP-14.27-7.95-28.58-M*	.562 / 14.27	.313 / 7.95	1.125 / 28.58	250	OR	
SR-TP-13.67-7.1-25	.538 / 13.67	.279 / 7.14	.984 / 25.0	500		\$ 263.63
SR-TP-15.0-10.0-25.4	.590 / 15.0	.393 / 10.0	1.000 / 25.4	100		\$ 41.00
SR-TP-15.9-11.1-20.7	.625 / 15.9	.437 / 11.1	.813 / 20.7	200		\$ 84.83
SR-TP-17.0-13.0-25.4	.669 / 17.0	.510 / 13.0	1.000 / 25.4	200		\$ 104.60

\* For the same size plug in EPDM rubber, subtract 10% from pricing.  
Change the prefix from "SR-TP" to "EP-TP"

## Silicone Rubber Tapered Plugs: High Temperature & Heat Resistant Large Sizes



- High Temperature natural color Silicone Rubber for use at 500°F / 260°C continuous and up to 600°F / 316°C intermittent short duration.
- Also available in EPDM (black) with a lower temperature range (425°F / 218°C).

### High Temperature, Heat & Flame Resistant Silicone Rubber Tapered Plugs Small Size: 13.67mm x 7.1mm x 25mm to 127mm x 90mm x 50mm

Part Number	Large End Diameter in / mm	Small End Diameter in / mm	Length in / mm	Quantity	Price
SR-TP-19.0-14.0-25.4	.748 / 19.0	.550 / 14.0	1.000 / 25.4	100	\$ 113.65
SR-TP-20.0-16.0-25.4	.787 / 20.0	.630 / 16.0	1.000 / 25.4	100	\$ 79.65
SR-TP-20.24-13.7-25.0	.797 / 20.24	.538 / 13.7	.984 / 25.0	200	\$ 257.30
SR-TP-23.8-18.0-25.4	.938 / 23.8	.708 / 18.0	1.000 / 25.4	100	\$ 87.08
SR-TP-24.0-15.9-25.4	.945 / 24.0	.625 / 15.9	1.000 / 25.4	100	\$ 76.65
SR-TP-26.0-20.0-25.4	1.024 / 26.0	.787 / 20.0	1.000 / 25.4	100	\$ 101.50
SR-TP-27.0-23.0-25.4	1.063 / 27.0	.905 / 23.0	1.000 / 25.4	100	\$ 115.50
SR-TP-28.0-24.0-25.4	1.102 / 28.0	.945 / 24.0	1.000 / 25.4	25	\$ 91.00
SR-TP-28.0-24.0-25.4	1.102 / 28.0	.945 / 24.0	1.000 / 25.4	50	\$ 128.00
SR-TP-28.0-24.0-25.4	1.102 / 28.0	.945 / 24.0	1.000 / 25.4	100	\$ 146.00
SR-TP-30.0-27.8-25.4	1.181 / 30.0	1.094 / 27.8	1.000 / 25.4	12	\$ 75.36
SR-TP-30.0-27.8-25.4	1.181 / 30.0	1.094 / 27.8	1.000 / 25.4	25	\$ 109.50
SR-TP-30.0-27.8-25.4	1.181 / 30.0	1.094 / 27.8	1.000 / 25.4	50	\$ 125.00
SR-TP-32.0-26.0-25.4	1.260 / 32.0	1.024 / 26.0	1.000 / 25.4	25	\$ 113.50
SR-TP-32.0-26.0-25.4	1.260 / 32.0	1.024 / 26.0	1.000 / 25.4	50	\$ 159.00
SR-TP-32.0-26.0-25.4	1.260 / 32.0	1.024 / 26.0	1.000 / 25.4	100	\$ 180.00
SR-TP-34.0-27.0-25.4	1.338 / 34.0	1.063 / 27.0	1.000 / 25.4	25	\$ 124.50
SR-TP-34.0-27.0-25.4	1.338 / 34.0	1.063 / 27.0	1.000 / 25.4	50	\$ 174.00
SR-TP-34.0-27.0-25.4	1.338 / 34.0	1.063 / 27.0	1.000 / 25.4	100	\$ 198.00
SR-TP-37.0-30.0-25.4	1.456 / 37.0	1.180 / 30.0	1.000 / 25.4	12	\$ 75.60
SR-TP-37.0-30.0-25.4	1.456 / 37.0	1.180 / 30.0	1.000 / 25.4	25	\$ 110.00
SR-TP-37.0-30.0-25.4	1.456 / 37.0	1.180 / 30.0	1.000 / 25.4	50	\$ 125.00
SR-TP-37.0-30.0-25.4-BL	1.456 / 37.0	1.180 / 30.0	1.000 / 25.4	100	\$ 250.00
SR-TP-38.7-22.9-63.5	1.525 / 38.7	.900 / 22.9	2.500 / 63.5	100	\$
SR-TP-38.7-22.9-63.5	1.525 / 38.7	.900 / 22.9	2.500 / 63.5	100	\$ 525.63
SR-TP-39.0-31.0-25.4	1.535 / 39.0	1.220 / 31.0	1.000 / 25.4	12	\$ 80.88
SR-TP-39.0-31.0-25.4	1.535 / 39.0	1.220 / 31.0	1.000 / 25.4	25	\$ 117.50
SR-TP-39.0-31.0-25.4	1.535 / 39.0	1.220 / 31.0	1.000 / 25.4	50	\$ 134.00
SR-TP-41.0-33.0-25.4	1.614 / 41.0	1.300 / 33.0	1.000 / 25.4	12	\$ 84.96
SR-TP-41.0-33.0-25.4	1.614 / 41.0	1.300 / 33.0	1.000 / 25.4	25	\$ 124.00
SR-TP-41.0-33.0-25.4	1.614 / 41.0	1.300 / 33.0	1.000 / 25.4	50	\$ 141.00

**High Temperature, Heat & Flame Resistant Silicone Rubber Tapered Plugs**  
**Small Size: 13.67mm x 7.1mm x 25mm to 127mm x 90mm x 50mm**

Part Number	Large End Diameter in / mm	Small End Diameter in / mm	Length in / mm	Quantity	Price
SR-TP-43.0-36.0-25.4	1.693 / 43.0	1.417 / 36.0	1.000 / 25.4	12	\$ 93.36
SR-TP-43.0-36.0-25.4	1.693 / 43.0	1.417 / 36.0	1.000 / 25.4	25	\$ 136.00
SR-TP-43.0-36.0-25.4	1.693 / 43.0	1.417 / 36.0	1.000 / 25.4	50	\$ 155.00
SR-TP-45.0-37.0-25.4	1.772 / 45.0	1.457 / 37.0	1.000 / 25.4	12	\$ 107.04
SR-TP-45.0-37.0-25.4	1.772 / 45.0	1.457 / 37.0	1.000 / 25.4	25	\$ 156.00
SR-TP-45.0-37.0-25.4	1.772 / 45.0	1.457 / 37.0	1.000 / 25.4	50	\$ 178.00
<b>SR-TP-45.0-37.0-25.4-RD</b>	<b>1.772 / 45.0</b>	<b>1.457 / 37.0</b>	<b>1.000 / 25.4</b>	<b>50</b>	<b>\$ 178.00</b>
SR-TP-46.0-38.0-25.4	1.810 / 46.0	1.496 / 38.0	1.000 / 25.4	12	\$ 107.76
SR-TP-46.0-38.0-25.4	1.810 / 46.0	1.496 / 38.0	1.000 / 25.4	25	\$ 157.50
SR-TP-46.0-38.0-25.4	1.810 / 46.0	1.496 / 38.0	1.000 / 25.4	50	\$ 179.00



**High Temperature, Heat & Flame Resistant Silicone Rubber Tapered Plugs**  
**Small Size: 50.0mm x 42.0mm x 25.4mm to 127mm x 90mm x 50mm**

Part Number	Large End Diameter in / mm	Small End Diameter in / mm	Length in / mm	Quantity	Price
SR-TP-50.0-42.0-25.4	1.968 / 50.0	1.653 / 42.0	1.000 / 25.4	6	\$ 67.44
SR-TP-50.0-42.0-25.4	1.968 / 50.0	1.653 / 42.0	1.000 / 25.4	12	\$ 94.32
SR-TP-50.0-42.0-25.4	1.968 / 50.0	1.653 / 42.0	1.000 / 25.4	25	\$ 112.50
SR-TP-53.0-45.0-25.4	2.086 / 53.0	1.770 / 45.0	1.000 / 25.4	6	\$ 71.16
SR-TP-53.0-45.0-25.4	2.086 / 53.0	1.770 / 45.0	1.000 / 25.4	12	\$ 99.60
SR-TP-53.0-45.0-25.4	2.086 / 53.0	1.770 / 45.0	1.000 / 25.4	25	\$ 118.00
SR-TP-56.0-48.0-25.4	2.203 / 56.0	1.890 / 48.0	1.000 / 25.4	6	\$ 83.16
SR-TP-56.0-48.0-25.4	2.203 / 56.0	1.890 / 48.0	1.000 / 25.4	12	\$ 116.16
SR-TP-56.0-48.0-25.4	2.203 / 56.0	1.890 / 48.0	1.000 / 25.4	25	\$ 138.50
SR-TP-56.0-48.0-25.4-BL	2.203 / 56.0	1.890 / 48.0	1.000 / 25.4	25	\$ 138.50
SR-TP-63.0-50.0-25.4	2.480 / 63.0	1.968 / 50.0	1.000 / 25.4	6	\$ 93.12
SR-TP-63.0-50.0-25.4	2.480 / 63.0	1.968 / 50.0	1.000 / 25.4	12	\$ 130.56
SR-TP-63.0-50.0-25.4	2.480 / 63.0	1.968 / 50.0	1.000 / 25.4	25	\$ 155.00
SR-TP-64.0-54.0-25.4	2.500 / 63.5	2.125 / 54.0	1.000 / 25.4	6	\$ 100.68
SR-TP-64.0-54.0-25.4	2.500 / 63.5	2.125 / 54.0	1.000 / 25.4	12	\$ 140.88
SR-TP-64.0-54.0-25.4	2.500 / 63.5	2.125 / 54.0	1.000 / 25.4	25	\$ 167.50
SR-TP-64.0-54.0-25.4-YL	2.500 / 63.5	2.125 / 54.0	1.000 / 25.4	25	\$ 167.50
SR-TP-68.0-58.0-25.4	2.677 / 68.0	2.283 / 58.0	1.000 / 25.4	6	\$ 112.92
SR-TP-68.0-58.0-25.4	2.677 / 68.0	2.283 / 58.0	1.000 / 25.4	12	\$ 157.92
SR-TP-68.0-58.0-25.4	2.677 / 68.0	2.283 / 58.0	1.000 / 25.4	25	\$ 187.50
SR-TP-75.0-62.0-35.0	2.953 / 75.0	2.440 / 62.0	1.377 / 35.0	1	\$ 60.32
SR-TP-75.0-62.0-35.0	2.953 / 75.0	2.440 / 62.0	1.377 / 35.0	6	\$ 164.28
SR-TP-75.0-62.0-35.0	2.953 / 75.0	2.440 / 62.0	1.377 / 35.0	12	\$ 230.16
SR-TP-75.0-62.0-35.0	2.953 / 75.0	2.440 / 62.0	1.377 / 35.0	25	\$ 273.50
SR-TP-90.0-75.0-39.0	3.543 / 90.0	2.953 / 75.0	1.535 / 39.0	1	\$ 94.50
SR-TP-90.0-75.0-39.0	3.543 / 90.0	2.953 / 75.0	1.535 / 39.0	6	\$ 257.76
SR-TP-90.0-75.0-39.0	3.543 / 90.0	2.953 / 75.0	1.535 / 39.0	12	\$ 360.72
SR-TP-90.0-75.0-39.0	3.543 / 90.0	2.953 / 75.0	1.535 / 39.0	25	\$ 429.00
SR-TP-103.0-83.0-39.0	4.055 / 103.0	3.267 / 83.0	1.535 / 39.0	1	\$ 193.10
SR-TP-103.0-83.0-39.0	4.055 / 103.0	3.267 / 83.0	1.535 / 39.0	5	\$ 438.70
SR-TP-103.0-83.0-39.0	4.055 / 103.0	3.267 / 83.0	1.535 / 39.0	10	\$ 614.40
SR-TP-103.0-83.0-39.0	4.055 / 103.0	3.267 / 83.0	1.535 / 39.0	20	\$ 701.60
SR-TP-127.0-90.0-50.0	5.000 / 127.0	3.543 / 90.0	1.968 / 50.0	1	\$ 106.36
SR-TP-127.0-90.0-50.0	5.000 / 127.0	3.543 / 90.0	1.968 / 50.0	5	\$ 372.30
SR-TP-127.0-90.0-50.0	5.000 / 127.0	3.543 / 90.0	1.968 / 50.0	10	\$ 425.40

- For the same size plug in EPDM rubber, subtract 10% from pricing. Change prefix from "SR-TP" to "EP-TP"



## Silicone Rubber Hollow Tapered Plugs High Temperature & Heat Resistant



- High Temperature natural color Silicone Rubber for use at 500°F / 260°C continuous and up to 600°F / 316°C intermittent short duration.
- Also available in EPDM (black) with a lower temperature range (425°F / 218°C).

High Temperature, Heat & Flame Resistant Silicone Rubber Hollow Tapered Plugs Small Size: 13.67mm x 7.1mm x 25mm to 127mm x 90mm x 50mm					
Part Number	Large End Diameter in / mm	Small End Diameter in / mm	Length in / mm	Pack Size	Price each
SR-HTP-27.0-20.3-25.4	1.061 / 27.0	.797 / 20.3	1.000 / 25.4	200	\$ 343.05
SR-HTP-30.0-27.8-25.4	1.181 / 30.0	1.094 / 27.8	1.000 / 25.4	50	\$ 73.91
SR-HTP-37.0-30.0-25.4	1.456 / 37.0	1.180 / 30.0	1.000 / 25.4	50	\$ 88.35
SR-HTP-39.0-31.0-25.4	1.535 / 39.0	1.220 / 31.0	1.000 / 25.4	50	\$ 96.83
SR-HTP-41.0-33.0-25.4	1.614 / 41.0	1.300 / 33.0	1.000 / 25.4	50	\$ 106.03
SR-HTP-43.0-36.0-25.4	1.693 / 43.0	1.417 / 36.0	1.000 / 25.4	50	\$ 113.80
SR-HTP-45.0-37.0-25.4	1.772 / 45.0	1.457 / 37.0	1.000 / 25.4	50	\$ 127.10
SR-HTP-46.0-38.0-25.4	1.810 / 46.0	1.496 / 38.0	1.000 / 25.4	50	\$ 126.53
SR-HTP-50.0-42.0-25.4	1.968 / 50.0	1.653 / 42.0	1.000 / 25.4	25	\$ 69.98
SR-HTP-53.0-45.0-25.4	2.086 / 53.0	1.770 / 45.0	1.000 / 25.4	25	\$ 77.75
SR-HTP-56.0-48.0-25.4	2.203 / 56.0	1.890 / 48.0	1.000 / 25.4	25	\$ 91.18
SR-HTP-63.0-50.0-25.4	2.480 / 63.0	1.968 / 50.0	1.000 / 25.4	25	\$ 113.10
SR-HTP-64.0-54.0-25.4	2.520 / 64.0	2.125 / 54.0	1.000 / 25.4	25	\$ 120.18
SR-HTP-68.0-58.0-25.4	2.677 / 68.0	2.283 / 58.0	1.000 / 25.4	25	\$ 134.30
SR-HTP-75.0-62.0-35.0	2.953 / 75.0	2.440 / 62.0	1.377 / 35.0	25	\$ 201.45
SR-HTP-90.0-75.0-39.0	3.543 / 90.0	2.953 / 75.0	1.535 / 39.0	25	\$ 272.13
SR-HTP-103.0-83.0-39.0	4.055 / 103.0	3.267 / 83.0	1.535 / 39.0	20	\$ 367.55
SR-HTP-127.0-90.0-50.0	5.000 / 127.0	3.543 / 90.0	1.968 / 50.0	10	\$ 281.33

- For the same size plug in EPDM rubber, subtract 10% from pricing. Change prefix from "SR-HTP" to "EP-HTP"

## Silicone Rubber Straight Plugs High Temperature & Heat Resistant



- High Temperature natural color Silicone Rubber for use at 500°F / 260°C continuous and up to 600°F / 316°C intermittent short duration.
- Also available in EPDM (black) with a lower temperature range (425°F / 218°C).

High Temperature, Heat & Flame Resistant Silicone Rubber Straight Plugs Small Size: .047" to .275" (1.2mm to 7.0mm)						
Part Number	Large End Diameter in / mm	Small End Diameter in / mm	Large Diameter Length in / mm	Small Diameter Length in / mm	Pack Size	Price each
SR-SP-1.6-1.2	.062 / 1.6	.047 / 1.2	.375 / 9.5	.337 / 8.6		\$ Call
SR-SP-1.7-1.2	.067 / 1.7	.047 / 1.2	.625 / 15.9	.610 / 15.5		\$ Call
SR-SP-1.9-1.2	.073 / 1.9	.047 / 1.2	.612 / 15.5	.590 / 15.0		\$ Call
SR-SP-2.3-1.6	.091 / 2.3	.062 / 1.6	.625 / 15.9	.625 / 15.9		\$ Call
SR-SP-2.4-1.6	.093 / 2.4	.062 / 1.6	.700 / 17.8	.700 / 17.8		\$ Call
SR-SP-2.7-1.8	.105 / 2.7	.070 / 1.8	1.000 / 25.4	1.000 / 25.4		\$ Call
SR-SP-2.8-1.6	.109 / 2.8	.062 / 1.6	1.000 / 25.4	1.000 / 25.4		\$ Call
SR-SP-3.0-2.1	.118 / 3.0	.082 / 2.1	1.000 / 25.4	1.000 / 25.4		\$ Call
SR-SP-3.2-2.1	.125 / 3.2	.082 / 2.1	.625 / 15.9	.625 / 15.9		\$ Call
SR-SP-3.3-2.1	.130 / 3.3	.082 / 2.1	.650 / 16.5	.700 / 17.8		\$ Call
SR-SP-3.6-2.1	.140 / 3.6	.082 / 2.1	.625 / 15.9	.558 / 14.2		\$ Call
SR-SP-3.9-2.1	.154 / 3.9	.082 / 2.1	.632 / 16.1	.625 / 15.9		\$ Call
SR-SP-4.0-2.1	.156 / 4.0	.082 / 2.1	.625 / 15.9	.750 / 19.1		\$ Call
SR-SP-4.0-2.4	.158 / 4.0	.093 / 2.4	1.250 / 31.8	1.250 / 31.8		\$ Call
SR-SP-4.1-2.4	.162 / 4.1	.093 / 2.4	.625 / 15.9	.581 / 14.8		\$ Call
SR-SP-4.7-2.8	.187 / 4.7	.110 / 2.8	.625 / 15.9	.600 / 15.2		\$ Call
SR-SP-5.0-2.8	.195 / 5.0	.110 / 2.8	.625 / 15.9	.625 / 15.9		\$ Call
SR-SP-5.0-2.8	.197 / 5.0	.110 / 2.8	1.000 / 25.4	1.000 / 25.4		\$ Call
SR-SP-5.5-2.8	.218 / 5.5	.110 / 2.8	1.000 / 25.4	1.000 / 25.4		\$ Call
SR-SP-5.7-3.2	.225 / 5.7	.125 / 3.2	1.000 / 25.4	1.000 / 25.4		\$ Call
SR-SP-6.5-3.3	.257 / 6.5	.130 / 3.3	1.000 / 25.4	1.000 / 25.4		\$ Call
SR-SP-7.0-3.3	.275 / 7.0	.130 / 3.3	.937 / 23.8	.920 / 23.4		\$ Call

- For the same size plug in EPDM rubber, subtract 10% from pricing. Change prefix from "SR-HTP" to "EP-HTP"

## Silicone Rubber Straight Plugs High Temperature & Heat Resistant



- High Temperature natural color Silicone Rubber for use at 500°F / 260°C continuous and up to 600°F / 316°C intermittent short duration.
- Also available in EPDM (black) with a lower temperature range (425°F / 218°C).

High Temperature, Heat & Flame Resistant Silicone Rubber Straight Plugs Small Size: .281" to 1.380" (7.1mm to 35.1mm)						
Part Number	Large End Diameter in / mm	Small End Diameter in / mm	Large Diameter Length in / mm	Small Diameter Length in / mm	Pack Size	Price each
SR-SP-7.1-3.5	.281 / 7.1	.138 / 3.5	1.000 / 25.4	.920 / 23.4		\$ Call
SR-SP-7.9-3.7	.312 / 7.9	.147 / 3.7	1.250 / 31.8	1.250 / 31.8		\$ Call
SR-SP-8.4-6.4	.332 / 8.4	.250 / 6.4	.757 / 19.2	1.100 / 27.9		\$ Call
SR-SP-8.5-4.0	.335 / 8.5	.157 / 4.0	1.000 / 25.4	1.000 / 25.4		\$ Call
SR-SP-8.9-4.0	.350 / 8.9	.157 / 4.0	.881 / 22.4	.925 / 23.5		\$ Call
SR-SP-9.9-4.0	.388 / 9.9	.157 / 4.0	1.000 / 25.4	1.000 / 25.4		\$ Call
SR-SP-10.2-4.9	.400 / 10.2	.191 / 4.9	1.009 / 25.6	1.000 / 25.4		\$ Call
SR-SP-10.5-4.0	.414 / 10.5	.157 / 4.0	.525 / 13.3	.755 / 19.2		\$ Call
SR-SP-11.2-6.5	.440 / 11.2	.255 / 6.5	1.000 / 25.4	.990 / 25.2		\$ Call
SR-SP-11.3-4.0	.445 / 11.3	.157 / 4.0	1.000 / 25.4	1.000 / 25.4		\$ Call
SR-SP-11.9-6.4	.468 / 11.9	.250 / 6.4	1.000 / 25.4	1.000 / 25.4		\$ Call
SR-SP-12.7-6.4	.500 / 12.7	.250 / 6.4	1.000 / 25.4	1.000 / 25.4		\$ Call
SR-SP-13.0-6.4	.510 / 13.0	.250 / 6.4	1.000 / 25.4	1.000 / 25.4		\$ Call
SR-SP13.5-6.4	.530 / 13.5	.250 / 6.4	1.000 / 25.4	1.000 / 25.4		\$ Call
SR-SP15.5-6.4	.612 / 15.5	.250 / 6.4	1.000 / 25.4	1.000 / 25.4		\$ Call
SR-SP-16.3-9.5	.640 / 16.3	.375 / 9.5	1.000 / 25.4	1.000 / 25.4		\$ Call
SR-SP-17.8-9.5	.700 / 17.8	.375 / 9.5	1.250 / 31.8	1.326 / 33.7		\$ Call
SR-SP-19.6-9.5	.770 / 19.6	.375 / 9.5	1.000 / 25.4	.927 / 23.6		\$ Call
SR-SP-22.8-9.5	.896 / 22.8	.375 / 9.5	1.000 / 25.4	1.000 / 25.4		\$ Call
SR-SP-25.9-9.5	1.020 / 25.9	.375 / 9.5	1.000 / 25.4	.970 / 24.6		\$ Call
SR-SP-35.1-12.7	1.380 / 35.1	.500 / 12.7	1.000 / 25.4	1.000 / 25.4		\$ Call

- For the same size plug in EPDM rubber, subtract 10% from pricing. Change prefix from "SR-HTP" to "EP-HTP"

## Silicone Rubber Adhesive, Sealant, End-Seal Dip & Paint High Temperature, Heat & Flame Resistant

### Adhesive / Sealant



#### US-HTG-165 \$ 32.67 / cartridge

- Easy to use 10.3 oz cartridge fits caulking guns.
- Available in larger pail and bucket sizes.
- Fills gaps, seals enclosures, forms gaskets.
- 500°F / 260°C continuous rating.

#### US-HT-903 \$ 46.64 / cartridge (\$221.86 1 gallon pail)

- Easy to use 10.3 oz cartridge fits caulking guns.
- Available in larger pail and bucket sizes.
- Highest Temperature Rating Silicone Adhesive / Sealant at 300°C continuous rating.
- Great for Kiln and exhaust systems.

#### US-SRB-201 \$ 109.68 / cartridge

- Easy to use 10.3 oz cartridge fits caulking guns.
- Available in larger pail and bucket sizes.
- Cures in 60 seconds with hot air gun
- Specialty high temperature adhesive to bond silicone rubbers together – great for complex high temperature silicone rubber fabrics used in covers and protective blanket systems

### End Seal Dip / Paint / Ink (Shake well or stir before use)



#### US-LD-1 End Seal Dip

- Easy to use 1/2 litre wide mouth jar.
- Available in larger jars & cans.
- Used to seal the ends of sleeve to prevent wicking of liquids and to prevent fraying. 500°F / 260°C continuous rating.
- Tack free in 40 minutes, cures at room temperature in 6 hours. Odor free. Non corrosive and meets Mil-A-46146 as per NAVAIR 01-1A-20.
- Add following codes to part number: –OR for oxide-red; –BLK for black; –WHT for white; –GRN for green; –BRN for brown; –YEL for yellow; –BLU for Blue
- 4oz packaged in a 2.25" ID wide mouth jar: \$ 18.76
- 1 pint (16oz) (approx 1 lb or 455g) \$46.47.
- 1 quart (32oz) (approx 2 lbs or 907g) \$ 87.20
- 1 gallon: \$229.32 / 5 gallon: \$988.40.

#### US-LP-1 Paint / Ink

- 500°F / 260°C continuous rating.
- Tack free in 40 minutes, cures at room temperature in 6 hours. Odor free.
- May be brushed or sprayed as a high-temperature protective coating. Can be thinned with xylene or odourless mineral spirits to alter its viscosity.
- Add following codes to part number: –OR for oxide-red; –BLK for black; –WHT for white; –GRN for green; –BRN for brown; –YEL for yellow; –BLU for Blue
- 4oz packaged in a 2.25" ID wide mouth jar: \$ 18.76
- 1 pint (16oz) (approx 1 lb or 455g) \$46.47. 1 quart (32oz) (approx 2 lbs or 907g) \$ 87.20. 1 gallon: \$229.32 / 5 gallon: \$988.40

## DuctSeal™ Commercial Kitchen Silicone Rubber Adhesive & Sealant High Temperature, Heat, Flame & Fire Resistant

NSF Listed / Meets FDA-USDA requirements

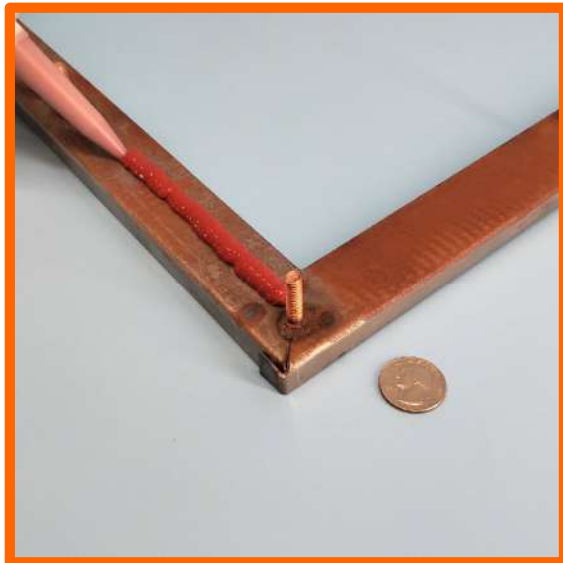

### Part Numbers:

**DSP-10-OR**

**\$ 37.47 / 10oz cartridge**

**DSP-3-OR**

**\$ 15.61 / 3oz tube**

- Fills gaps, seals enclosures, forms gaskets.
- 500°F / 260°C continuous rating. High Temperature Red Color.
- NSF Listed (NSF International STD 51).
- Meets FDA Extractive Requirements CFR 177.2600, CFR 175.105
- USDA Rating P-1
- TT-S-001543A, TT-S-00230C
- U.L. Recognized
- Meets MIL-A-46106A Type I
- 10oz cartridge fits standard caulking gun.
- Case quantity of 12: 15% discount
- CONTENTS:  
7631-86-9 silica, amorphous, fumed,  
4253-34-3 methyltriacetoxysilane,  
17689-77-9 ethyltriacetoxysilane,  
70131-67-8 polydimethylsiloxane,  
hydroxy terminated  
polydimethylsiloxane 63148-62-9
- **Volatile Organic Content (VOC): 30 grams/liter**

This sealant is used in Commercial Kitchen applications, including duct flange gasket sealing and access door sealing. Also used on pipe flanges to form gaskets at pharmaceutical manufacturing facilities.



## Semi-Cured Silicone Rubber Bulk Compound High Temperature, Heat & Flame Resistant



- Used to form gaskets, make repairs, mold small quantity run custom parts.
- Also used to make silicone rubber sheet, coat fabrics, sleeves and tapes.
- Available as a 25 pound block, boxed. Pricing is approximately \$95.00 per pound. Operational temperature range of the cured silicone rubber is -70°F to +450°F.

Semi-Cured Silicone Rubber Bulk Compound						
Part Number	Color	Tensile	Elongation %	Durometer	Cure	Price
US-BULK-903	Red	800	500	45	A	\$ Call
US-BULK-930G	Green	800	500	45	A	\$ Call
US-BULK-930R	Red	800	500	45	A	\$ Call
US-BULK-966	Red	900	200	60	A	\$ Call
US-BULK-1164	Red	450	275	60	A	\$ Call
US-BULK-1017	Red	650	300	55	A	\$ Call
US-BULK-1104	Red	800	150	65	A	\$ Call
US-BULK-1125	Red	850	450	48	B	\$ Call
US-BULK-1170	Off White	900	150	80	A	\$ Call
US-BULK-1230R	Red	925	550	36	C	\$ Call
US-BULK-1230XD	Dark Gray	925	550	36	C	\$ Call
US-BULK-1242	Red	800	225	60	D	\$ Call
US-BULK-1281	Red	800	225	60	D	\$ Call
US-BULK-1302	Red	900	300	60	D	\$ Call
US-BULK-1425	Red	800	230	53	B	\$ Call
US-BULK-1479	Brown	1000	450	55	A	\$ Call
US-BULK-1482	Brown	1000	450	55	A	\$ Call
US-BULK-1494	White	840	130	74	D	\$ Call
US-BULK-1497	Light Blue	850	400	55	A	\$ Call
US-BULK-1530	Red	800	225	60	D	\$ Call
US-BULK-1782	Gray	685	124	77	D	\$ Call
US-BULK-8877	Red	900	500	50	B	\$ Call
US-BULK-11748	Red	700	550	55	E	\$ Call

Cure: A = Primary 250-350F for 15 minutes. Secondary 400F for 120 minutes  
 B = Primary 350F for 15 minutes under pressure. Secondary 425F for 120 minutes  
 C = Primary 300F for 15 minutes under pressure. Secondary 400F for 120 minutes  
 D = Primary 250F for 15 minutes at 50 psi. Secondary 400F for 120 minutes  
 E = Primary 250F for 15 minutes under pressure. No secondary

Dielectric for all versions is 400 V/mil minimum.

Due to fluctuations of the price of the component chemicals, price is by quotation.

## High Temperature Silicone Rubber Extruded Profiles Gasket and Seal Shapes Heat, Flame, Molten Splash & Weld Splatter Resistant



Silicone rubber extruded profiles make excellent gaskets and seals. Can be used for applications up to 500°F / 260°C continuous rating with weld splatter / molten metal splash protection. These silicone rubber products provide excellent cold temperature performance with flexibility to -76°C for refrigeration and cryogenic applications.

We offer the ability to produce many standard shapes such as:

- Tadpole
- "P" strips
- "T" Strips
- "D" Bumpers
- "L" Strips
- "U" channels
- Half rounds
- Round (cord)
- Square
- Rectangle
- Top Hat
- Baseball Hat
- Double Hat

For a full list and catalogue of available extruded profile shapes, please visit [www.siliconetechnologies.com](http://www.siliconetechnologies.com).

These profiles are also available in Fluorosilicone, Viton Fluoroelastomer, Nitrile NBR Rubber, Neoprene, Hypalon, EPDM, SBR Rubber, Polyurethane, Natural Rubber.

All pricing on extruded products is by quotation.

## Silicone Rubber Electrical Flexible Strip Heaters High Temperature, Heat & Flame Resistant



These heaters are commonly used to prevent condensation from forming in outdoor equipment such as motors and enclosures. Can be embedded under sleeving on piping to regulate process temperatures.

500°F / 260°C continuous rating with weld splatter / molten metal splash and solder drip protection. These silicone rubber products provide excellent cold temperature performance with flexibility to -76°C for refrigeration and cryogenic applications.

5 watts per inch of length. 0.055" thick. UL and CSA certified. 8" leads.

<b>High Temperature, Heat &amp; Flame Resistant Silicone Rubber Electrical Flexible Strip Heaters</b>		
<b>Part Number</b>	<b>Size / Watts / Voltage</b>	<b>Price</b>
SR-FSH-251	1" x 5", 25 watt, 120 volt	\$ 55.70
SR-FSH-252	1" x 5", 25 watt, 240 volt	\$ 55.70
SR-FSH-501	1" x 10", 50 watt, 120 volt	\$ 58.46
SR-FSH-502	1" x 10", 50 watt, 240 volt	\$ 58.46
SR-FSH-751	1" x 15", 75 watt, 120 volt	\$ 65.90
SR-FSH-752	1" x 15", 75 watt, 240 volt	\$ 65.90
SR-FSH-1001	1" x 20", 100 watt, 120 volt	\$ 72.50
SR-FSH-1002	1" x 20", 100 watt, 240 volt	\$ 72.50
SR-FSH-1251	1" x 25", 125 watt, 120 volt	\$ 84.50
SR-FSH-1501	2" x 15", 150 watt, 120 volt	\$ 86.73
SR-FSH-1502	2" x 15", 150 watt, 240 volt	\$ 86.73
SR-FSH-2001	2" x 20", 200 watt, 120 volt	\$ 88.60
SR-FSH-2002	2" x 20", 200 watt, 240 volt	\$ 88.60
SR-FSH-2501	2" x 25", 250 watt, 120 volt	\$ 92.38
SR-FSH-2502	2" x 25", 250 watt, 240 volt	\$ 92.38

## Electrical Flexible Strip Heaters Polyimide & Silicone Rubber



- Ultra thin profile
- High wattage density
- Uniform heat distribution
- 12" Teflon coated leads
- Pressure sensitive adhesive backing
- UL / CSA Approved and RoHS compliant
- Polyimide Film is useable to 392°F / 200°C. 0.01" / 0.25mm total thickness. This is the thinnest and highest dielectric strength.
- Silicone Rubber is useable to 450°F / 232°C. 0.06" / 1.52mm total thickness. High moisture and chemical resistance.

Etched Foil Heaters with 12" Teflon Leads						
Part Number	Material	Size	Resistance Ohms	Watts/Voltage	Density w/in <sup>2</sup>	Price
HTR-P-1X1SQ-115	Polyimide Film	1" x 1" Square	115	5 / 24 VDC	5	\$ 48.43
HTR-P-1X1SQ-225	Polyimide Film	1" x 1" Square	225	2.6 / 24 VDC	2.6	\$ 48.43
HTR-SR-1RD-55	Silicone Rubber	1" Round	55	10.5 / 24 VDC	13.3	\$ 48.43
HTR-SR-1X2RT-65	Silicone Rubber	1" x 2" Rectangle	65	8.9 / 24 VDC	4.4	\$ 48.43
HTR-SR-1X2RT-135	Silicone Rubber	1" x 2" Rectangle	135	4.3 / 24 VDC	2.1	\$ 48.43
HTR-P-1X4RT-25	Polyimide Film	1" x 4" Rectangle	25	23 / 24 VDC	5.8	\$ 52.65
HTR-P-1X4RT-775	Polyimide Film	1" x 4" Rectangle	775	18.6 / 120 VAC	4.6	\$ 52.64
HTR-SR-1X5RT-13	Silicone Rubber	1" x 5" Rectangle	13	44.3 / 24 VDC	18.9	\$ 52.64
HTR-SR-1X5RT-1235	Silicone Rubber	1" x 5" Rectangle	1235	11.7 / 120 VAC	2.3	\$ 52.64
HTR-SR-1X10RT-25	Silicone Rubber	1" x 10" Rectangle	25	23 / 24 VDC	2.3	\$ 58.77
HTR-SR-1XRT-325	Silicone Rubber	1" x 10" Rectangle	325	44 / 120 VAC	4.4	\$ 58.77
HTR-P-2X2SQ-30	Polyimide Film	2" x 2" Square	30	19.2 / 24 VDC	4.8	\$ 54.83
HTR-P-2X2SQ-390	Polyimide Film	2" x 2" Square	390	9.2 / 120 VAC	9.2	\$ 54.83
HTR-P-2RD-74	Polyimide Film	2" Round	74	7.8 / 24 VDC	2.5	\$ 54.83
HTR-P-2X5RT-6.5	Polyimide Film	2" x 5" Rectangle	6.5	88.6 / 24 VDC	8.9	\$ 58.77
HTR-P-2X5RT-585	Polyimide Film	2" x 5" Rectangle	585	24.6 / 120 VAC	2.5	\$ 58.77
HTR-P-3X3SQ-4.5	Polyimide Film	3" x 3" Square	4.5	128 / 24 VDC	14.2	\$ 58.77
HTR-P-3X3SQ-625	Polyimide Film	3" x 3" Square	625	23 / 120 VAC	2.6	\$ 58.77
HTR-SR-3RD-465	Silicone Rubber	3" Round	465	31 / 120 VAC	4.4	\$ 58.77
HTR-SR-5X5SQ-2.5	Silicone Rubber	5" x 5" Square	2.5	230 / 24 VAC	9.2	\$ 74.91
HTR-SR-5X5SQ-220	Silicone Rubber	5" x 5" Square	220	65.5 / 120 VAC	2.6	\$ 74.91
HTR-SR-5RD-30	Silicone Rubber	5" Round	30	480 / 120 VAC	24.5	\$ 74.91

## Drum & Pail Heaters – Standard Duty



- Helps speed the flow of high viscosity fluids such as oils, lubes, foods.
- Provides freeze protection.
- Does not contaminate or scorch product.
- Heating element is laminated between two layers of 15 mil fiberglass reinforced silicone rubber.
- Adjustable thermostat 50°F to 425°F (10°C to 218°C)
- Moisture and chemical resistant.
- Spring connects each end of heater band to hold itself onto drum/pail.

Standard Drum & Pail Heaters			
Part Number	Size	Voltage	Price
SR-DPH-MET5-X	5 gallon (19 litre) 300 watt	120 / 240	\$ 143.00
SR-DPH-MET5-X	5 gallon (19 litre) 550 watt	120 / 240	\$ 143.00
SR-DPH-POLY5-X	5 gallon (19 litre) 150 watt	120 / 240	\$ 143.00
SR-DPH-MET15-X	15 gallon (57 litre) 500 watt	120 / 240	\$ 155.00
SR-DPH-MET15-X	15 gallon (57 litre) 700 watt	120 / 240	\$ 155.00
SR-DPH-POLY15-X	15 gallon (57 litre) 200 watt	120 / 240	\$ 155.00
SR-DPH-MET30-X	30 gallon (114 litre) 750 watt	120 / 240	\$ 167.00
SR-DPH-MET30-X	30 gallon (114 litre) 1000 watt	120 / 240	\$ 167.00
SR-DPH-POLY30-X	30 gallon (114 litre) 250 watt	120 / 240	\$ 167.00
SR-DPH-MET55-X	55 gallon (208 litre) 1100 watt	120 / 240	\$ 176.00
SR-DPH-MET55-X	55 gallon (208 litre) 1200 watt	120 / 240	\$ 176.00
SR-DPH-POLY55-X	55 gallon (208 litre) 300 watt	120 / 240	\$ 176.00

For the X value, specify "120" for 120 volt or "240" for 220-240 volt operation



## Drum & Pail Heaters – Heavy Duty / Heavy Duty with CSA Approval



- Helps speed the flow of high viscosity fluids such as oils, lubes, foods.
- Provides freeze protection.
- Does not contaminate or scorch product.
- Heating element is laminated between two layers of 20 mil fiberglass reinforced silicone rubber.
- Adjustable thermostat 50 to 160F for poly drums. 50 to 425F.
- Moisture and chemical resistant.
- Spring connects each end of heater band to hold itself onto drum/pail.

Heavy Duty Drum & Pail Heaters (Non CSA)			
Part Number	Size	Voltage	Price
SR-DPH-HD-MET5-X	5 gallon (19 litre) 550 watt	120 / 240	\$ 193.00
SR-DPH-HD-POLY5-X	5 gallon (19 litre) 150 watt	120 / 240	\$ 193.00
SR-DPH-HD-MET15-X	15 gallon (57 litre) 700 watt	120 / 240	\$ 212.00
SR-DPH-HD-POLY15-X	15 gallon (57 litre) 200 watt	120 / 240	\$ 212.00
SR-DPH-HD-MET30-X	30 gallon (114 litre) 1000 watt	120 / 240	\$ 238.00
SR-DPH-HD-POLY30-X	30 gallon (114 litre) 250 watt	120 / 240	\$ 238.00
SR-DPH-HD-MET55-X	55 gallon (208 litre) 1200 watt	120 / 240	\$ 266.00
SR-DPH-HD-POLY55-X	55 gallon (208 litre) 300 watt	120 / 240	\$ 266.00

For the X value, specify "120" for 120 volt or "240" for 220-240 volt operation

Heavy Duty Drum & Pail Heaters with CSA Approval			
Part Number	Size	Voltage	Price
SR-DPH-HD-C-MET-X	5 gallon (19 litre) 550 watt	120 / 240	\$ 197.00
SR-DPH-HD-C-POLY5-X	5 gallon (19 litre) 150 watt	120 / 240	\$ 197.00
SR-DPH-HD-C-MET15-X	15 gallon (57 litre) 700 watt	120 / 240	\$ 219.00
SR-DPH-HD-C-POLY15-X	15 gallon (57 litre) 200 watt	120 / 240	\$ 219.00
SR-DPH-HD-C-MET30-X	30 gallon (114 litre) 1000 watt	120 / 240	\$ 245.00
SR-DPH-HD-C-POLY30-X	30 gallon (114 litre) 250 watt	120 / 240	\$ 245.00
SR-DPH-HD-C-MET55-X	55 gallon (208 litre) 1200 watt	120 / 240	\$ 273.00
SR-DPH-HD-C-POLY55-X	55 gallon (208 litre) 300 watt	120 / 240	\$ 273.00

For the X value, specify "120" for 120 volt or "240" for 220-240 volt operation

**Drum Heaters – Hazardous Area Approved – T3 and T4A**  
**FM Approved – Class I, Div 2 Groups A, B, C and D.**  
**Class II Div 2 Groups F and G**



- Helps speed the flow of high viscosity fluids such as oils, lubes, foods.
- Provides freeze protection.
- Does not contaminate or scorch product.
- T3 high limit is set to 292°F (145°C).
- T4A high limit is set to 158°F (70°C).
- Heating element is laminated between two layers of 23 mil fiberglass reinforced silicone rubber.

<b>Hazardous Area Approved Drum Heaters for T3 and T4A Environments</b>			
<b>Part Number</b>	<b>Size</b>	<b>Voltage</b>	<b>Price</b>
SR-DPH-HZ-MET30-X-Y	30 gallon (114 litre) 1000 watt	120 / 240	\$ 2078.00
SR-DPH-HZ-MET55-X-Y	55 gallon (208 litre) 1200 watt	120 / 240	\$ 2127.00

For the X value, specify “120” for 120 volt or “240” for 220-240 volt operation

For the Y value, specify “3” for the T3 version or “4” for the T4A version

## Stranded Tinned Copper Wire – with High Temperature High Flexibility Silicone Rubber Extruded Jacket

### Tuff-Flex™ for Extreme Flexibility for Confined Area and Motion Applications

-65°C to 260°C



- For applications up to 42,000 Volts DC. Submersible.
- Excellent alternative to PVC & PTFE jacketed wire.
- Available from 4 to 30 AWG.
- UL 94-V0/CSA and FAA Flame Tested. Excellent for long term UV exposure.
- Used in Aerospace, Solar Panel, Robotic, Medical, Oil & Gas Exploration, Wind Turbine and Welding Applications.
- Used by NASA's JPL for MSL Robot Arm (Mars Rover).
- Class 1 clean room rated (zero particulates). Meets ASTM E-595 for low out-gassing.
- Halogen free.
- Multi-conductor and Flat Cable versions.
- Jacket is 65 (Shore A) durometer.

### Stranded Tinned Copper Wire with High Temperature & High Flexibility Silicone Rubber Extruded Jacket

#### Single Conductor

Part Number	AWG	Volts DC	Amp rating (at 70°F)	OD inch	Price per foot
W-SR-1C-30AWG-10KV-3A-21	30	10K	3	.21"	\$ 1.91
W-SR-1C-28AWG-12KV-5A-21	28	12K	5	.21"	\$ 1.96
W-SR-1C-26AWG-12KV-6A-22	26	12K	6	.22"	\$ 2.04
W-SR-1C-24AWG-12KV-7A-22	24	12K	7	.22"	\$ 2.19
W-SR-1C-22AWG-31KV-8A-23	22	31K	8	.23"	\$ 2.46
W-SR-1C-20AWG-31KV-10A-24	20	31K	10	.24"	\$ 2.73
W-SR-1C-18AWG-42KV-15A-25	18	42K	15	.25"	\$ 3.42
W-SR-1C-16AWG-42KV-19A-26	16	42K	19	.26"	\$ 3.56
W-SR-1C-14AWG-42KV-27A-28	14	42K	27	.28"	\$ 4.24
W-SR-1C-12AWG-42KV-36A-30	12	42K	36	.30"	\$ 4.52
W-SR-1C-10AWG-42KV-47A-33	10	42K	47	.33"	\$ 5.19
W-SR-1C-8AWG-42KV-65A-39	8	42K	65	.39"	\$ 5.99
W-SR-1C-6AWG-42KV-95A-44	6	42K	95	.44"	\$ 6.49
W-SR-1C-4AWG-42KV-125A-50	4	42K	125	.50"	\$ 7.99

- High Tensile, Bare Copper and Silver Plated conductors available.
- Available as bulk wire or assembled with connectors.
- Multi-Conductor Flat Cable version available.

## High temperature silicone based Ink for printing on Silicone Rubber and EPDM / EPR Rubber

### Sil-Ink™ One Component: 41 cSt viscosity



Formulated with a Silicone resin and solvent carrier. High adhesion one-part ink designed for printing primarily on silicone rubber and can also be used on EPDM and EPR with very good results. Must be thoroughly mixed prior to use.

Sil-Ink™ Thinner can be used to replace solvent loss during application process.

Additional Colors of Blue, Brown, Green, Gray, Orange, Red, Violet, Silver and Yellow are available with minimum quantity of 2 gallons. Metallic Gold and Non-metallic Gold also available.

Standard printing techniques of offset, stamping, silk screening, pad, and stencil work well with this ink. Not suitable for ink-jet printing.

This ink should be tested with your application; results may vary.

Supplied in metal cans. Ships as Hazardous.

Sales are final – No return on Ink.

**SL Version** – This is a special formulation ink for slower drying applications. Excellent adhesion to silicone. Some heat is beneficial to the curing process.

SL is available in White (1 gallon minimum) and Black and Blue (2 gallon minimums for both).

Sil-Ink™ High Temperature Ink for printing on Silicone Rubber and EPDM / EPR Rubber			
Part Number	Size	Color	Price
INK-1COMP-16-BK	16 oz	Black	\$ 66.00
INK-1COMP-32-BK	32 oz	Black	\$ 105.00
INK-1COMP-128-BK	128 oz	Black	\$ 310.00
INK-1COMP-128-WT	128 oz	White	\$ 310.00 / Gal
INK-1COMP-256-XX	128 oz x 2	Blue, Yellow, Silver, Red	\$ 690.00 / 2 Gal
INK-1COMP-256-XX	128 oz x 2	Brown, Green, Gray, Orange, Violet	\$ 890.00 / 2 Gal
INK-1COMP-128-GOLDMT	128 oz	Gold - metallic	\$ 467.00 / Gal
INK-1COMP-SL-256-BK	128 oz x 2	Black	\$ 660.00 / 2 Gal
INK-1COMP-SL-128-WT	128 oz	White	\$ 330.00 / Gal
INK-1COMP-SL-256-BL	128 oz x 2	Blue	\$ 660.00 / 2 Gal
SIL-INK-THINNER	128 oz	Clear Thinner	\$ 136.33 / Gal

For the "X" value, substitute:

BL for Blue, BR for Brown, GR for Green, GY for Gray, OR for Orange, RD for Red, VI for Violet, SI for Silver, YL for Yellow

## **Sil-Ink™ High Temperature Ink for printing on Silicone Rubber and EPDM / EPR Rubber**

### **One Component Medium Viscosity**

#### **US-LD-1 End Seal Dip**

- Easy to use 1/2 litre wide mouth jar.
- Available in larger jars & cans.
- Used to seal the ends of sleeve to prevent wicking of liquids and to prevent fraying. 500°F / 260°C continuous rating.
- Tack free in 40 minutes, cures at room temperature in 6 hours. Odor free. Non corrosive and meets Mil-A-46146 as per NAVAIR 01-1A-20.
- Add following codes to part number: -OR for oxide-red; -BLK for black; -WHT for white; -GRN for green; -BRN for brown; -YEL for yellow; -BLU for Blue
- 4oz packaged in a 2.25" ID wide mouth jar: \$ 18.76
- 1 pint (16oz) (approx 1 lb or 455g) \$46.47.
- 1 quart (32oz) (approx 2 lbs or 907g) \$ 87.20
- 1 gallon: \$229.32 / 5 gallon: \$988.40.



**Thermal, EMI/RFI & Abrasion Protection Materials**

Fax Orders: 610-340-9054 Telephone Orders: 610-906-3549 [orders@abthermal.com](mailto:orders@abthermal.com)

---





**High Temperature, Heat, Flame, Fire, Molten Metal & Weld Splatter Protection Materials**

*Fax Orders: 610-340-9054 Telephone Orders: 610-906-3549 orders@abthermal.com*

---

---



# Section 10

## Fire Retardants

## Fire Stops

## Fire Blocks

## Fire Rated Wire – Cable - Pipe Transits

Fire Retardant Fabric Spray – UserMixed .....	10-1
Fire Rated Expanding Foam Fire Stop .....	10-2
Fire Rated Acrylic Caulk Fire Stop .....	10-3
Fire Rated Motar Fire Stop .....	10-4
Fire Rated Retrofit Split Sleeve Firestop for Wire Cable Passthrough Transt .....	10-5



User Mixed Fire  
Retardant Fabric Spray  
Page 10-1



Expanding Foam  
Firestop – UL1479  
Page 10-2

**Fire retardant impregnation for fabric, cloth & paper**  
**Spray – User Mixed. For chairs, couches, curtains, wall coverings and hangings**



Proprietary formulation effectively retards ignition and the spread of flames on natural and synthetic fibers and fabrics.

User mixes the impregnation powder with water at the ratio of 1 Lb (455g) of product per gallon of water for natural fabrics and 1.5 lb of product per gallon for mixed and synthetic fabrics. May also be used on paper, cardboard and non-painted wood surfaces.

1 gallon of mixed formulation covers approximately 100 sq ft of material.

Used to protect chairs, couches, curtains, wall coverings & hangings, paper & wood.

The mixed solution can be sprayed easily using a pump bottle obtained from most large department retailers or garden centres. Ensure that the pump bottle is appropriately labelled.

This formulation is not suitable for application onto non-woven and woven plastics such as polyethylene tarps or groundsheets as those materials do not absorb the formulation.

Not for use on apparel, garments or workwear.



The resulting mixture is a tested “A” Class Fire Retardant spray for curtains, fabric and upholstery, and meets CAN/ULC S109.

Also meets NEN-EN-ISO 6941/6940; DIN 4102, class B1, B2; DIN 66082 / 84; BS 5438, 5867, 5852; NFP-92 503, class M1-M3

Items washed must be re-sprayed. Items dry-cleaned must be re-sprayed after 5 dry-clean cycles.

Available in 1 pound (455 gram) jars, 5 pound cans, 20 pound pails and larger quantities.

Fire Retardant Fabric Spray Impregnation Powder		
Part Number	Size	Price
FR-FS-11	1 lb jar	\$ 62.00

## Fire Rated Expanding Foam Firestop FlameShield™ 2 Hour rating meeting UL1479 – tested to ASTM-E-814



FlameShield™ expanding foam firestop is tested to ASTM E-814 and meets UL 1479 to provide a 2 hour firestop.

Designed to prevent the spread of fire and smoke from one compartment to another through gaps, cracks and voids through fire rated walls and floors.

Excellent adhesion to most building materials. Unaffected by moisture and humidity after curing. Provides a strong and semi-rigid seal.

CFC free, easy to install and finish.

The 24 oz can provides .997 cubic foot of volume when cured. The 10 oz can provides .41 cubic foot of volume when cured.

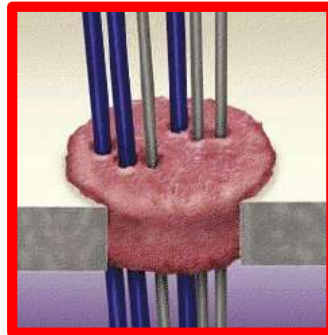

FlameShield™ Fire Rated Expanding Foam Firestop		
Part Number	Size	Price
FR-FS-FOAM-24	24oz	\$ 45.87
FR-FS-FOAM-10	10oz	\$ 26.73



Classification system:  
NFPA ratings (scale 0 - 4)



HMIS-ratings (scale 0 - 4)



Harmful  
Extremely flammable



## Fire Rated Acrylic Intumescent Caulk Firestop FlameShield™ Meeting UL1479 – tested to ASTM-E-814



FlameShield™ fire rated acrylic intumescent caulk is designed to prevent the spread of fire from one compartment to another wherever services wires, cables and pipes penetrate separating walls and floors, or wherever a gap remains between elements in fire rated walls or floors.

This single part water based acrylic caulk provides a firm but flexible seal to joints in a variety of fire rated structures. It will not support combustion, and when exposed to fire it forms a carbonaceous char which expands to effectively seal any gaps, and prevents the spread of smoke and fire.

- Available in a variety of packaging sizes.
- Fast cure – tack free in 75 minutes.
- Excellent adhesion to most building materials.
- Excellent slump resistance.

FlameShield™ Fire Rated Acrylic Intumescent Caulk Firestop		
Part Number	Size	Price
FR-FS-CAULK-AIC-10C-R	10.5oz	\$ 19.63
FR-FS-CAULK-AIC-20C-R	20oz	\$ 34.17
FR-FS-CAULK-AIC-2G5-R	2.5 Gal Pail	\$ 354.00
FR-FS-CAULK-AIC-10-5G-R	5 Gal Pail	\$ 588.42
FR-FS-CAULK-AIC-10C-W	10.5oz	\$ 19.63

**Fire Rated Mortar Firestop**  
**FlameShield™ 4 Hour rated mortar Meeting UL1479 – tested to ASTM-E-814**

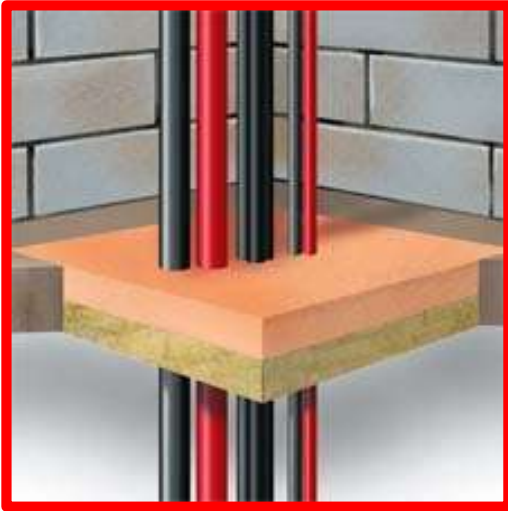

FlameShield™ fire rated mortar firestop is easy to mix and use, and is ideal for irregular holes and defects.

This is a lightweight mortar compound that is designed to prevent the spread of fire from one compartment to another where services penetrate fire rated walls and floors.

FlameShield Mortar consists of a specially blended powder, supplied in easy to handle bags. When mixed with water, it forms a trowable or pourable mixture that is easy to install.

When exposed to the heat of a fire, the excellent thermal insulation properties provides an effective barrier, preventing the passage of fire and smoke. Unlike sand and cement mortars or concrete, the special formulation resists shrinkage, cracking, and does not spall.

During the curing process, this mortar slightly expands ensuring that an excellent seal is made even in irregular openings.

<b>FlameShield™ 4 Hour Fire Rated Mortar Firestop</b>		
<b>Part Number</b>	<b>Size</b>	<b>Price</b>
FR-FS-MORTAR	20kg / 44 lbs	\$ 166.34

## Split-Sleeve Firestop for Retrofit Wire & Cable Passthrough Transit 2 and 4 Hour rated retrofit firestops for wire and cable passthrough of rated walls and floors



FlameShield™ retrofit split-sleeve fire rated firestop passthrough transit for wires and cables is the easy way to bring non-compliant installations into code passing compliance.

Simply clean up the existing hole to allow installation of the split sleeve, add the collars and support rings, insert the intrumescent putty and you have a finished retrofit that will pass inspection.

Available in several sizes and ratings for vertical fire rated walls and floors.

<b>FlameShield™ Retrofit Split Sleeve Wire &amp; Cable Firestop Passthrough Transits: UL 1479 classified for up to 4 hours</b>		
<b>Part Number</b>	<b>Size</b>	<b>Price</b>
FR-FS-METAL-SS-1	1" Kit	\$ 81.66
FR-FS-METAL-SS-2	2" Kit	\$ 98.93
FR-FS-METAL-SS-4	4" Kit	\$ 141.34
FR-FS-FK-1	Extra Putty	\$ 37.57

Other sizes, configurations available. Floor penetration and membrane penetration kits available.



**Thermal, EMI/RFI & Abrasion Protection Materials**

Fax Orders: 610-340-9054 Telephone Orders: 610-906-3549 [orders@abthermal.com](mailto:orders@abthermal.com)

---

---



**Thermal, EMI/RFI & Abrasion Protection Materials**

Fax Orders: 610-340-9054 Telephone Orders: 610-906-3549 [orders@abthermal.com](mailto:orders@abthermal.com)

---

Intentionally Blank





**High Temperature, Heat, Flame, Fire, Molten Metal & Weld Splatter Protection Materials**

*Fax Orders: 610-340-9054 Telephone Orders: 610-906-3549 orders@abthermal.com*

---

---

## **Section 11**

# **High Temperature Sealants and Adhesives**

- Silicone Adhesives & Sealant
- Ceramic Adhesives
- Ceramic Metallic Pastes
- High Temperature Corrosion Protection Coatings



Silicone High  
Temperature Sealants  
and Adhesives  
Page 11-1



Silica High Temperature  
Stove Gasket Sealants  
Page 11-2

## Silicone Rubber Adhesive, Sealant High Temperature, Heat & Flame Resistant

### FlameShield™ Paste Adhesive / Sealant



#### **US-ABST-HTG-165 \$ 32.67 / cartridge**

- Easy to use 10.3 oz cartridge fits caulking guns.
- Available in larger pail and bucket sizes.
- Fills gaps, seals enclosures, forms gaskets.
- 500°F / 260°C continuous rating.

#### **US-ABST-HT-903 \$ 46.64 / cartridge**

- Easy to use 10.3 oz cartridge fits caulking guns.
- Available in larger pail and bucket sizes.
- Highest Temperature Rating Silicone Adhesive / Sealant at 300°C continuous rating.
- Great for Kiln and exhaust systems.

#### **US-ABST-SRB-201 \$ 58.87 / cartridge**

- Easy to use 10.3 oz cartridge fits caulking guns.
- Available in larger pail and bucket sizes.
- Cures in 60 seconds with hot air gun
- Specialty high temperature adhesive to bond silicone rubbers together – great for complex high temperature silicone rubber fabrics used in covers and protective blanket systems

## High Temperature Silica Based Gasket Cement Adhesive / Sealant

### FlameShield™ Liquid Gel Adhesive / Sealant



#### **ABST-SGC-2200 \$ 22.67 / tube**

- Use for a high-temperature rigid seal.
- Adheres to all porous fibrous gasket materials.
- Can be used to effect repairs of cracks on stoves, stovepipe and masonry.
- Withstands up to 2000°F / 1093°C.
- 2 fluid oz. 59ml. Squeeze tube.
- Use by applying thin film over entire gasket channel or contact surface. Wait until tacky (10 minutes). Apply gasket material firmly into place.
- Elevate to 250°F / 121°C to fully cure

Please Note: These products are custom produced to order in small batches and all sales are final.

## DuctSeal™ FDA Kitchen Duct High Temperature Sealant:



This sealant is used to form a bead ahead of the gasket tape in the flange area in order to keep grease from contaminating the tape.

Can be used to 400°F continuous without degradation.

In the event of a fire, the elevated temperatures will decompose the sealant, turning it into a white insulating powder through a process called caramilization.

During the fire, the gasket tape itself will maintain the seal in the flange. The sealant is available in Oxide-Red color.

Available in two sizes:

- 3 oz squeeze tube.  
P/N DS-DSP-03-OR \$16.61
- 10.3 oz caulking gun cartridge.  
P/N DS-DSP-10-OR \$37.47

- UL recognized, USDA P-1 rated and NSF Standard 51 listed
- FDA approved - meets extraction requirements No. 21 CFR177.2600
- TT-S-001543A
- TT-S-00230C
- ASTM C 920
- Meets MIL-A-46106A Type 1 specifications
- VOC: <30g/L
- 24-30 month shelf life from BOD date stamped on packaging
- Stable & flexible from -60°C (-76°F) to 204°C (400°F) with intermittent peaks to 260°C (500°F)
- Not for use on porous surfaces, surfaces that will be painted or for applications with prolonged water emersion



## High Temperature Ceramic Adhesives 1560°F / 850°C to 3200°F / 1760°C

These are unique high temperature inorganic ceramic adhesive formulations for bonding and sealing ceramics, metals, quartz, graphite, carbons, textiles and composite materials and structures. High thermal and electrical resistance.

High Temperature Ceramic Adhesives					
Part Number	Filler	Feature	Bonding	Use	Price per Pint*
UCA-1509-1	Alumina	High Fired Strength	C-C	Dense Ceramics	\$ 184.21
UCA-1656-1	Alumina	Adhesion to Metal	C-C; C-M	Low CTE Metals, SOFC's	\$ 184.21
UCA-1707-1	Alumina	Set at Room Temperature. Good Filler	C-C; C-M	Probes, Sensors	\$ 184.21
UCA-1800-1	Alumina	Ceramic Fiber Reinforced	C-C	Refractory Repair	\$ 184.21
UCA-2013-1	Alumina	High Adhesion	C-C; C-M; M-M	Textiles, Threadlocking	\$ 184.21
UCA-2505-1	Alumina	High Strength. Good filler	C-C; C-M	Halogen Lamps	\$ 184.21
UCA-2505 MB-2	Alumina	High Strength. Good filler	C-C; C-M	Halogen Lamps	\$ 184.21
UCA-2439-1	Alumina	Fiber reinforced sealer	C-C; C-M	Tundish Nozzles	\$ 184.21
UCA-2595-1	Aluminum Nitride	High Thermal Conductivity	C-C; C-M	Probes, Sensors	\$ 269.87
UCA-2004-1	Alumina-Silica	Set at Room Temperature. Good Filler	C-C; C-Met	Oxygen Sensors	\$ 184.21
UCA-2031-1	Alumina-Silica	Set at Room Temperature. Good Filler	C-C; C-Met	Induction Coils	\$ 184.21
UCA-2070-1	Boron Nitride	Good Fired Strength	C-C	Boron Nitride	\$ 184.21
UCA-1653RN-1	Graphite	High Adhesive Strength	Graphite, Carbon	Structures, Molds	\$ 219.68
UCA-2007-1	Graphite	Ceramic Fiber Reinforced	Graphite, Carbon	Structures, Molds	\$ 184.21
UCA-1713-2	Magnesium Oxide	Dielectric, High Strength	C-M; M-M	Heaters, Sensors	\$ 184.21
UCA-1854-1	Silica	Low CTE, Good Strength	C-C; Quartz	Tubes, Vessels, Sensors	\$ 184.21
UCA-1548-1	Zirconia	Dielectric, Moisture Resistant	C-C; C-M; M-M	Thermocouples	\$ 184.21
UCA-2055-1	Zirconia	Bonds Plated Metals to Ceramic	C-M	Heaters, Ignitors, Gasketing	\$ 184.21
UCA-2505-1	Zirconia	Fiber reinforced, sets room temperature	C-C; C-M	Halogen Lamps	\$ 184.21
UCA-2655-1	Zirconia	Bonds and coats Zirconia, High Strength	C-C	Zirconia, SOFC's	\$ 184.21
UCA-2670-1	Silicon Carbide	Bonds SiC and Graphite Components	C-C, Graphite	High Vacuum Fixtures	\$ 184.21

Bonding: C-C is Ceramic-to-Ceramic; C-M is Ceramic-to-Metal; M-M is Metal-to-Metal. Last digit in the part number indicates number of components: 1 is a one part adhesive; 2 is a two part adhesive. Most 1 part adhesives are delivered with a six month shelf life.

\* Other sizes generally available are Quart, Gallon and 5 Gallon. For Quart size, price is 1.8 x Pint price. For Gallon size, price is 3.3 x Pint price. Some items incur higher shipping charges in sizes of 1 gallon and above due to classification as hazardous (Not classified as hazardous in smaller sizes).

Easy to use one and two component systems. Most are air dry at ambient temperature for 1-2 hours, followed by a 200°F to 700°F cure.

Please Note: These products are custom produced to order in small batches and all sales are final.



HIGH TEMPERATURE CERAMIC ADHESIVE & PASTE PROPERTIES																					
Product No.	1509	1656	1707	1800	2013	2439	2505M <sup>(6)</sup>	2004	2031	2595	2070	1653RN <sup>(1)</sup>	2007	1713	1854	2670	1548	2055	2505	2655	
Trade Name	CerMax	CerMax	CerMax	CerMax	CerMax	CerMax	CerMax	CerMax	CerMax	CerMax	CerMax	CerMax	CerMax	CerMax	CerMax	CerMax	CerMax	CerMax	CerMax	CerMax	
Major Constituent	Alumina																				
Maximum Temperature °F (°C)	3000 (1650)	3000 (1650)	3000 (1650)	2500 (1371)	3200 (1760)	3000 (1650)	3000 (1650)	2500 (1371)	2400 (1316)	3000 (1650)	1560 (850) 2700 (1482)	5400 (2985)	2500	3200 (1760)	3000 (1650)	2500 (1371)	3200 (1760)	2500 (1371)	2500 (1371)	3000 (1650)	
CTE, in/in/°F x 10 <sup>-6</sup> (°C)	4.0 (7.2)	4.3 (7.7)	4.2 (7.6)	4.2 (7.6)	4.1 (7.4)	4.0 (7.2)	4.0 (7.2)	4.0 (7.2)	4.1 (7.4)	1.5 (2.7)	2.0 (3.6)	4.1 (7.4)	4.2 (7.6)	7.0 (12.6)	33 (59)	2.4 (4.4)	4.1 (7.4)	4.5 (8.1)	4.0 (7.2)	4.0 (7.2)	
Volume Resistivity, ohm-cm @ RT (@ 1000 °F)	10 <sup>10</sup> (10 <sup>8</sup> )	10 <sup>10</sup> (10 <sup>8</sup> )	10 <sup>10</sup> (10 <sup>8</sup> )	10 <sup>10</sup> (10 <sup>8</sup> )	10 <sup>10</sup> (10 <sup>8</sup> )	10 <sup>10</sup> (10 <sup>8</sup> )	10 <sup>10</sup> (10 <sup>8</sup> )	10 <sup>10</sup> (10 <sup>8</sup> )	10 <sup>10</sup> (10 <sup>8</sup> )	10 <sup>15</sup> (10 <sup>13</sup> )	10 <sup>15</sup> (10 <sup>13</sup> )	NA (NA)	NA (NA)	10 <sup>10</sup> (10 <sup>8</sup> )	10 <sup>10</sup> (10 <sup>8</sup> )	NA	10 <sup>10</sup> (10 <sup>8</sup> )	10 <sup>10</sup> (10 <sup>8</sup> )	10 <sup>10</sup> (10 <sup>8</sup> )	10 <sup>10</sup> (10 <sup>8</sup> )	
Dielectric Strength, volts per mil @ RT (@ 1000 °F)	253 (240)	250 (80)	256 (100)	200 (80)	250 (97)	250 (80)	245 (95)	245 (95)	200 (100)	500 (300)	500 (300)	NA (NA)	NA (NA)	255 (100)	200 (180)	NA	250 (80)	200 (150)	200 (100)	250 (80)	
Torque Strength, ft-lbs <sup>(2)</sup>	5.6	6.7	6.0	8.3	24.0	18.5	8.5	10.6	6.3	8.3	NA	9.5	2.1	21.6	5.2	10.5	8.6	9.0	7.5	8.0	
Moisture Resistance <sup>(5)</sup>	Good	Excellent	Excellent	Good	Excellent	Excellent	Good	Excellent	Excellent	Excellent	Good	Excellent	Excellent	Excellent	Excellent	Good	Good	Excellent	Good	Good	
Alkali Resistance <sup>(5)</sup>	Fair	Good	Good	Good	Excellent	Excellent	Excellent	Excellent	Good	Good	Good	Good	Good	Good	Good	Good	Excellent	Good	Good	Good	
Acid Resistance <sup>(5)</sup>	Excellent	Good	Excellent	Fair	Good	Good	Good	Good	Good	Good	Good	Good	Good	Fair	Good	Good	Good	Good	Good	Good	
No. Components <sup>(1)</sup>	1	1	1	1	1	1	1	1	1	1	1	1	1	2	1	1	1	1	1	1	
Mix Ratio, powder:liquid	N/A	N/A	N/A	N/A	N/A	N/A	N/A	N/A	N/A	N/A	N/A	N/A	N/A	1.5:1	N/A	N/A	N/A	N/A	N/A	N/A	
Viscosity, cP	43,000	62,000	Paste	Paste	84,000	Paste	35,000	Paste	43,000	62,000	Paste	Paste	Paste	60,000	34,000	49,000	83,000	75,000	Paste	Paste	
Specific Gravity, gms/cc	2.50	2.07	2.30	2.16	2.24	2.18	2.41	2.09	2.17	2.01	1.40	1.56	1.58	1.50	1.60	2.18	2.24	1.85	2.41	2.99	
Air Set, hours	<1	1-4	1-4	2-4	1-4	4	2	1	1-4	1-4	1-4	1-4	1-4	1-4	1-4	<1	1-4	2-3	<1	<1	
Heat Cure, °F, hrs	200, 2 500, 2 700, 2	200, 2 500, 2	200, 2	200, 3	200, 2	200, 3 or 24/RT	200, 2	200, 1-5	200, 2	200, 2	200, 2 500, 2 700, 2	265, 4 500, 2	200, 2	200, 2	200, 2 500, 2 700, 2	200, 2 500, 2 700, 2	200, 2 500, 2 700, 2	200, 2 500, 2 700, 2	200, 2	200, 2	500, 2
Color	White	White	White	White	White	White	White	White	Off White	Gray	White	Black	Black	Beige	Light Gray	Gray	Tan	Tan	Tan	Tan	
Shelf Life, Months	6	6	6	6	6	3	6	6	6	6	6	6	6	6	6	6	6	6	6	6	
Storage, °F	40-90	40-90	40-90	40-90	40-90	40-90	40-90	40-90	40-90	40-90	40-90	40	40-90	40-90	40-90	40-90	40-90	40-90	40-90	40-90	

<b>CERAMIC ADHESIVE SELECTOR CHART</b>																					
MATERIAL	CTE X 10 <sup>-6</sup> in/in/ °F (°C)	1509	1548	1653RN	1656	1707	1713	1800	1854	2004	2007	2013	2031	2055	2070	2439	2505	2505M	2595	2655	2670
ALUMINA (96%)	4.4 (7.9)	•	X		X	X	X	•		•				X		•		•			
ALUMINUM NITRIDE	1.5 (2.7)					•			X	X					X	•	X	X	•		
BERYLLIA (95%)	4.1 (7.4)	•	X		X	X	X									X		X			
BORON CARBIDE	2.6 (4.6)					•			X	•											
BORON NITRIDE	4.2 (3.8)	•			X										•	X		X			
CERAMIC TEXTILES	—	•										•		X							
CORDIERITE	1.1 (1.9)								•					X	X	X					
GLASS (Borosilicate)	1.8 (3.2)	•							•					X	•		•				
GLASS BONDED MICA	5.8 (10.4)						X							X		X	X	X			
GRAPHITE	4.3 (7.7)	X	X	•							•										X
MACOR®	5.2 (9.4)					X	X			X				X		X	X	X			
MULLITE	3.0 (5.4)	•				X								X							
QUARTZ	0.3 (.56)	X				X			•						X		•				
SAPPHIRE	4.2 (7.6)	•						•		X		•									
SILICON CARBIDE	2.9 (5.2)	•													X				X		•
SILICON NITRIDE	1.8 (3.2)								X						X				X		
STEATITE	4.0 (7.2)	•	X		X	X								X		X	X	X			
ZIRCONIA			•											•			•				•
ZIRCONIA SILICATE			•											•			•				•
REFRACTORIES	—					•		•		•		•				•	•	X			
ALUMINUM	15.0 (27.0)						•							X			X				
BRASS	10.2 (18.4)						•						•	X			X				
CAST IRON	5.9 (10.6)		X		X	X	•					•		X							
COPPER	9.3 (16.7)						•						•								
INCONEL	6.4 (11.5)		X		X	•	X														
MOLYBDENUM	2.9 (5.2)		X		X	•			X											X	
NICKEL	7.2 (12.9)		X		X	X	•			X				X		X		X			
NICKEL-IRON	2.6 (4.7)		X		•	X	X			X						X		X			
PLATINUM	4.9 (8.8)	X													X						
SILICON	1.6 (2.9)	X	•		X	X									X						
SILVER	10.6 (19.1)						•														
S/S (300 SERIES)	9.6 (17.3)		X		X	X	•			X		•		X		X					
S/S (400 SERIES)	6.2 (16.6)						•					•		X							
STEEL (1010)	6.5 (11.7)		X		X	X	•			X		X		X		X	X	X			
TANTALUM	3.9 (7.0)	X	X		X	•	X			•	X					X					
TITANIUM	5.8 (10.4)					X	•			X											
TUNGSTEN	2.5 (4.5)		X		X	•			X	X					X	X				X	

• Preferred Product For This Application  
 X Applicable Product For This Application

# UCA High Temperature Ceramic Adhesives

## Design Guidelines

General design criteria for bonding with ceramic adhesives are similar to those for epoxies and other organic adhesives. Main considerations include the coefficient of thermal expansion, joint design, glue line thickness, operating environment, and an understanding of the suitability of ceramic adhesives.

### **Coefficient of Thermal Expansion**

Due to the thermal shock implicit in most ceramic adhesives applications, the joint design should account for the difference in the coefficient of thermal expansion between the adhesive and the components that are being joined. In the illustration above, note that the "poor" design loads the ceramic adhesive in tension, since the metal expands faster than the ceramic. The "good" design allows for this thermal mismatch and loads the adhesive in compression, offering higher reliability.

### **Glue Line Thickness**

The clearance between mating parts at operating temperature should be 2-8 mils (50–200 microns). Less than 2 mils will prevent uniform adhesion, and greater than 8 mils will often result in cohesive shear failure within the adhesive.

### **Operating Environment**

Ceramic adhesives offer excellent electrical, thermal and chemical resistance. In addition, ceramic adhesives, in contrast to organic based materials, will not outgas under high vacuum. All operating conditions such as temperature, thermal cycling, humidity, corrosion and electrical requirements should be considered before selecting a ceramic adhesive.

### **Joint Design**

Since ceramic adhesives exhibit relatively poor tensile and shear strength, it is desirable to design a joint that will distribute the mechanical stress. A glue line with greater surface area, such as a tongue-and-groove joint, should be used to reduce joint stress and increase mechanical strength.

### **Ceramic Adhesive Limitations**

Ceramic adhesives are somewhat brittle and may be affected by dynamic conditions such as vibration and mechanical shock. Expansion joints can be used to relieve stress. Adding ceramic cloth at the interface is also useful.

### **High Vacuum Applications**

Ceramic adhesives can be used under high vacuum conditions without outgassing. However, vacuum seals are difficult to produce unless the adhesive joint is sealed with a glass or glasslike coating. Refer to Technical Bulletin ABTG-A5 for glass sealants; refer to Technical Bulletin ABTG-A11 for high temperature inorganic binders.

## Application Procedures

Follow the guidelines below for applying high temperature adhesives. Make sure to read specific application instructions on container before use.

### **Surface Preparation**

Clean surfaces thoroughly prior to application. Extremely smooth surfaces are difficult to bond and should be roughened whenever possible. Porous substrates tend to absorb the adhesive binders and should be pre-coated with an adhesive thinner. Product thinners are designated by adding a "-T" to the part number (eg. 1509-T).

### **Mixing**

High temperature adhesives tend to settle in the container and should be mixed thoroughly and slowly to avoid air entrapment. Reduce viscosity as desired using the appropriate product thinner by up to 15% by weight. Two-component systems should be mixed according to the label instructions.

### **Application**

Apply adhesive to each surface in a thin coat using a brush, spatula or dispenser. Wet the surface thoroughly to ensure good adhesion. Maintain a uniform glue line thickness of 2-8 mils. Apply even pressure (clamp if possible), and wipe away excess material before drying. A graded adhesive joint is recommended when bonding components which have a gross difference in coefficient of thermal expansion (CTE). First coat each substrate with the adhesive that best matches its CTE, then use a third adhesive with an intermediate CTE to bond the parts together.

Example: Bond nickel to silica by pre-coating the nickel with 1713 and the silica with 1854.

Allow each substrate to air dry and cure at 200 °F for 1-2 hours. Apply 1656 as an intermediate adhesive and follow standard instructions in the Curing section. When it is necessary to use an adhesive alternatively as a coating, and several applications are required, allow the substrate to air dry for 1-2 hours before applying a second coat. A 200 °F cure for 1-2 hours is recommended for each successive coat to avoid blistering.

### **Curing**

In general all products should be air set for 1-4 hours, then heat cured at 200 °F (93 °C) for 1-4 hours minimum. 1509, 1548, 1854, 2070, 2655, and 2670 will not dry at room temperature and should be step cured at 200 °F (93 °C), 500 °F (260 °C), and 700 °F (372 °C) for 1-2 hours at each temperature. 1653-RN must be cured at 265° F (130 °C) for 4 hours and 500 °F (260°C) for 2 hours to develop maximum strength. Blistering may occur if the glue line is too thick or heating too rapid. Refer to specific product labels for detailed instructions.

### **Safety**

Read Material Safety Data Sheet carefully before use. All products except 1653 can be washed from the skin with mild soap and warm water. Prolonged skin contact should be avoided to prevent irritation. If any material contacts the eyes, flush continuously with water or neutralizing solutions, then consult a physician immediately.

## High Temperature Ceramic-Metallic Adhesive Paste 950°F / 510°C to 2300°F / 1260°C

These ceramic-metallic adhesive pastes are used to seal joints and repair metal defects in cast aluminum, cast iron, steel and stainless steel.

Resists temperatures to 2300F; used resurface and repair metal defects, reduces scrap, is machinable, strength increases with temperature, easily painted or powder coated, easy and safe to use.

High Temperature Ceramic-Metallic Pastes						
Part Number	UCMP-1959	UCMP-2850	UCMP-3000	UCMP-4500	UCMP-7200	UCMP-7500
Type	Inorganic	Organic	Inorganic	Inorganic	Inorganic	Inorganic
Filler	Stainless	Ceramic Fiber	Aluminum	Ceramic	Stainless	Iron Oxide
Max Temp F/C	2000 / 1093	950 / 510	1400 / 760	2300 / 1260	2000 / 1093	1600 / 871
Specific Gravity	1.9	1.09	1.8	1.27	1.50	2.90
Consistency	Paste	Paste	Paste	Paste	Paste	Paste
Components	1	1	2	1	1	1
Mix Ratio	N / A	N / A	2:1	N / A	N / A	N / A
Air Set, hours	2-4	N / A	2-4	1-2	2-4	2-4
Heat Cure, temp/hrs	200 / 3	400 / 1 or 225 / 6	160 / 1-2	200 / 1	200 / 2-4	200 / 3
Color	Gray	Silver Gray	Light Gray	Gray-Brown	Dark Gray	Black
Shelf Life, months	6	6	6	6	6	6
Storage, F	40-90	40-90	40-90	40-90	40-90	40-90
Packaging	Pt, Qt, Gal, 5 Gal	11oz cartridge	Pt, Qt, Gal, 5 Gal	Pt, Qt, Gal, 5 Gal 11oz cartridge	Pt, Qt, Gal, 5 Gal	Pt, Qt, Gal, 5 Gal
Price (Pt)	\$ 188.64	\$ 66.27 (MOQ = 2)	\$ 188.64	\$ 172.84 Pt \$ 53.77 11oz (MOQ = 2)	\$ 188.64	\$ 188.64

For Quart size, price is 1.8 x Pint price. For Gallon size, price is 3.3 x Pint price.

- UCMP-1959.** For vertical surfaces and applications to 1/2" thick. Repairs cast iron, steel and stainless steel parts to 2000F.
- UCMP-2850** Sealing High Temperature Flanges, Joints to 950F, 750 psi. Cures into a tough pliable inert material.
- UCMP-3000** For applications to 1/2" thick. Repairs cast aluminum parts to 1400F.
- UCMP-4500** PriAprily used to seal boiler doors and molten metal systems. Easy to apply and removable. Use up to 2300F.
- UCMP-7200** For applications to 3/8" thick. Repairs cast iron, steel and stainless parts to 2000F.
- UCMP-7500** For applications to 1/4" thick. Repairs cast iron and steel parts to 1600F.

**Applications: Afterburners, Boilers, Castings, Exhaust Stacks, Flanges, Furnaces, Headers, Incinerators, Manifolds, Molds and Dies, Ovens, Heat Exchangers, Pumps, Blowers, Piping, Ducting, Turbines.**

Please Note: These products are custom produced to order in small batches and all sales are final.



## UCMP Ceramic Metallic Paste Application Procedures

### Surface Preparation

All surfaces must be free of oil, grease, dirt, corrosives or other contaminants before application. Porous metal castings should be baked at high temperature to burn off embedded oils. Smooth metal surfaces should be abrasive blasted with a coarse media to a minimum SP-10 near white blast (0.001" minimum profile) for best results.

### Mixing

All products should be mixed thoroughly to a uniform consistency prior to use. Product viscosities may be reduced by adding a maximum of 5-10% by weight of the appropriate thinner. Thinner may be ordered by adding a "-T" to the product number (eg. 1959-T). The mix ratio for UCMP-3000 is 2.0 parts powder to 1.0-1.5 parts liquid by weight. This ratio will produce the consistency of a thick paste. UCMP-3000 will outgas slightly after mixing and it is recommended that the mixture be limited to the amount required for a specific application. Store mixed material at room temperature in a plastic container that is approximately twice the mixture volume. Allow to outgas for 24 hours. Remix contents thoroughly prior to use. Note that mixture will not begin to harden in a closed container for over 24 hours. Hardening will initiate when mixture is removed from container and exposed to air.

### Application

UCMP products may be applied using a spatula, putty knife or caulk gun. For cross-sections greater than 1/8" - 1/4" multiple applications should be made to avoid blistering. Cross-sections for all products should not exceed 1/2" - 3/4" (3/8" maximum for UCMP-7200).

### Curing

The following instructions are guidelines for curing. Alternative cure times may be appropriate depending on the size of the application.

#### UCMP-1959:

- 1) Air dry for 2 hours at room temperature and up to 4 hours for thick cross-sections.
- 2) Heat cure at 200 °F for 3 hours.
- 3) For multiple applications, air set for 1-2 hours between coats, then heat cure at 200 °F for 3-4 hours after the last coat.

#### UCMP-2850:

- 1) This product can be cured in service at the operating temperature of the equipment.
- 2) For curing before service, heat cure the joint without pressure at 400 °F for 30-60 minutes or 225 °F for 4-6 hours.

#### UCMP-3000:

- 1) A heat cure is not required for cross-sections less than 1/8" thick. Air dry at room temperature for a minimum of 2-4 hours prior to use.
- 2) A heat cure is recommended for cross-sections greater than 1/8" thick Air dry at room temperature for a minimum of 2-4 hours, then heat cure at 160 °F for 1-2 hours.
- 3) After curing, this product can be sanded to achieve a bright aluminum appearance.

#### UCMP-4500:

- 1) This product dries at room temperature and cures in service at the operating temperature of the equipment.

#### UCMP-7200:

- 1) Air dry at room temperature for a minimum of 5-7 hours, longer for thick cross-sections.
- 2) A heat cure is not required if the use temperature exceeds 400 °F. Otherwise, heat cure at 200 °F for 3 hours.

#### UCMP-7500:

- 1) Air dry at room temperature for a minimum of 1 hour, longer for thick cross-sections.
- 2) Heat cure at 200 °F for 2 hours or air dry at room temperature for 16 hours prior to use.

### Storage

Unopened containers have a six month shelf life when stored at room temperature. Make sure opened containers are capped securely to prevent evaporation. Place a plastic film in between the cap and container to prevent air leakage. The container may be inverted periodically to minimize settling. Store container between 40 °F and 90 °F.

### Safety

Read Material Safety Data Sheet carefully before using any of the above products. Prolonged skin contact should be avoided due to possible irritation. In the uncured state, materials can be washed from the skin with a mild soap and water. If any material contacts eyes, flush continuously with water or neutralizing solutions, then consult a physician immediately

## High Temperature Corrosion Protection Coatings

### 300°F / 150°C to 1500°F / 816°C

These corrosion protection coatings are based on a number of base compound groups:

Urethane / Epoxy / Inorganic Ceramic with various fillers / Silicone / Silicone-Polyester / Inorganic Ceramic-Zinc

### Urethane / Epoxy

<b>High Temperature Urethane / Epoxy Corrosion Protection Coatings</b>						
Part Number	<b>UCCPC-6000</b>	<b>UCCPC-6030</b>	<b>UCCPC-6060</b>	<b>UCCPC-6150</b>	<b>UCCPC-6180</b>	<b>UCCPC-6210</b>
Type	Urethane	Urethane	Urethane	Epoxy-Phenolic	Decolac-Epoxy	Decolac-Epoxy
Solids by Weight %	67.0	70.0	72.0	100.0	100.0	100.0
Solids by Volume %	49.0	66.0	77.0	100.0	100.0	100.0
Max Temp F/C	400 / 204	400 / 204	400 / 204	400 / 204	500 / 260	300 / 150 <sup>2</sup>
Specific Gravity	1.05	1.08	1.08	1.6	1.9	1.1
Mixed Viscosity, cP	200-240	300-600	200-500	Paste	Paste	800-1000
Thinner	Hi flash Naptha	Hi flash Naptha	Hi flash Naptha	NR	NR	Xylene
Components	1	1	1	2	2	2
Mix Ratio, by wt	N / A	N / A	N / A	1:1	100:8	100:42
WFT, mils (microns)	4.0 (101.6)	4.0 (101.6)	4.0 (101.6)	50+ (1270.0)	50+ (1270.0)	7.0 (177.8)
DFT, mils (microns)	2.0 (50.8)	2.6 (67.1)	3.1 (78.7)	50+ (1270.0)	50+ (1270.0)	7.0 (177.8)
Dry Film Coverage, @ 1mil, ft <sup>2</sup> /gal, m <sup>2</sup> /litre	722 (17.7)	1058 (25.9)	1235 (30.3)	1604 (39.3)	1604 (39.3)	1604 (39.3)
Application Temp F	50-90	50-90	50-90	50-90	50-90	50-90
Dry to Touch, hrs	4-6	4-6	4-6	6-8	4	5
Dry Handling, hrs	6-8	6-8	6-8	12-14	6-8	8
Recoat hrs (min/max)	3/7	6/12	3/7	4/48	4/8	4/8
Cure, min air set hrs	0.5	1	0.5	2	8	8
Cure, F/hrs	RT/24 or 250/1	RT/24 or 250/1	RT/24 or 250/1	RT/48 or 175/4	RT/48 or 250/6	RT/24
Flash Point, F(C)	140 (60)	140 (60)	140 (60)	>200 (93)	>200 (93)	>200 (93)
VOC's, lbs/gal	2.86	3.00	2.80	0.00	0.00	0.00
Color	Gloss Black	Aluminum <sup>1</sup>	Gloss Gray <sup>1</sup>	Brown	Gray	Gray
Pot Life, hrs RT	NA	NA	NA	.7	.75 (500 gms)	.35 (200 gms)
Packaging	Pt, Qt, Gal, 5 Gal	Pt, Qt, Gal, 5 Gal	Pt, Qt, Gal, 5 Gal	Pt, Qt, Gal, 5 Gal	Pt, Qt, Gal, 5 Gal	Pt, Qt, Gal, 5 Gal
Price (Pt)	\$ 188.64	\$ 188.64	\$ 188.64	\$ 198.91	\$ 198.91	\$ 188.64

Shelf Life for all products is 12 months at room temperature  
 Storage temperature for all products is 40-90 F  
 Primer for all products is not required

WFT = Wet Film Thickness  
 DFT = Recommended Dry Film Thickness  
 Dry Film Coverage numbers are theoretical: actual coverage will vary with material losses in mixing and application.

Please Note: These products are custom produced to order in small batches and all sales are final.





**Thermal, EMI/RFI & Abrasion Protection Materials**

Fax Orders: 610-340-9054 Telephone Orders: 610-906-3549 orders@abthermal.com

**NOTES:**

1. Product will discolour above 300°F.
2. Withstands intermittent service temperatures of 350-400 °F if cured for 2 hours at 185°F

**Further Technical Notes for Epoxy Coatings:**

Product	6150	6180
Hardness, Shore D	86	90
Lap Shear, strength to aluminum, psi		
@25C	2700	2300
@100C	1800	2000
@150C	900	1200
@175C	300	900
Flexural Strength, psi	13400	11500
Compressive Strength, psi	10300	12000
Elongation, %	3	2

**Surface Preparation for all products:**

All surfaces should be free of oil, grease, dirt, corrosives, oxides, paints or foreign matter. No further preparation is required when coating ceramics, refractories or graphites. Smooth metal surfaces should be further prepared as follows:

Abrasive blast to an SSPC-SP5 profile or etch surface using our UCPREP-6000 product. Apply for a maximum of 15 minutes, then rinse with warm water and dry rapidly.

Chemical Resistance Chart					
Chemical	Concentration	6000	6150	6180	6210
<b>ACIDS</b>					
Acetic Acid	20%	B	B	B	B
Acetic Acid	80%	B	B	B	B
Hydrochloric Acid	10%	A	A	A	A
Hydrochloric Acid	20%	A	A	A	A
Nitric Acid	10%	A	A	A	A
Nitric Acid	20%	B	B	B	B
Nitric Acid	50%	D	D	D	D
Nitric Acid	Concentrated	D	D	D	D
Phosphoric Acid	<40%	B	A	A	A
Phosphoric Acid	40-100%	D	C	C	C
Sulfuric Acid	10%	A	A	A	A
Sulfuric Acid	10-75%	C	B	B	B
Sulfuric Acid	75-100%	D	D	D	D
<b>BASES</b>					
Potassium Hydroxide		A	A	A	A
Sodium Hydroxide	20%	A	A	A	A
Sodium Hydroxide	50%	A	A	A	A
Sodium Hydroxide	80%	A	A	A	A
<b>Fuels &amp; Solvents</b>					
Acetone		B	B	B	B
Jet Fuel		A	A	A	A
Alcohol		A	A	A	A
Crude Oil		A	A	A	A
Diesel		A	A	A	A
Gasoline		A	A	A	A
Heptane		A	A	A	A
Kerosene		A	A	A	A
Methyl Ethyl Ketone		B	B	B	B
Methylene Chloride		B	B	A	A
Toluene		A	A	A	A
Xylene		A	A	A	A

### Inorganic Ceramic with various fillers

<b>High Temperature Inorganic Ceramic Corrosion Protection Coatings</b>						
<b>Part Number</b>	<b>UCCPC-9000</b>	<b>UCCPC-9045-AL</b>	<b>UCCPC-9045-BL</b>	<b>UCCPC-9045-GR</b>	<b>UCCPC-9045-SS</b>	<b>UCCPC-9045-WH</b>
Type	Inorganic	Inorganic	Inorganic	Inorganic	Inorganic	Inorganic
Solids by Weight %	53.2	36.8	50.0	44.5	42.3	40.0
Solids by Volume %	28.5	19.3	46.3	16.8	41.4	20.6
Max Temp F/C	1300 (704)	1200 (649)	1500 (816)	1400 (760)	1400 (760)	1500 (816)
Specific Gravity	1.55	1.32	1.54	1.38	1.47	1.37
Mixed Viscosity, cP	600-1200	250-900	600-900	300-700	200-500	600-900
Thinner	9000T	9045AL-T	9045BL-T	9045GR-T	9045SS-T	9045WH-T
Components	1	1	1	1	1	1
Mix Ratio, by wt	N / A	N / A	N / A	N / A	N / A	N / A
WFT, mils (microns)	3.52 (89.3)	5.20 (131.9)	2.16 (54.9)	6.00 (151.6)	2.42 (61.4)	4.87 (123.6)
DFT, mils (microns)	1.0 (25.4)	1.0 (25.4)	1.0 (25.4)	1.0 (25.4)	1.0 (25.4)	1.0 (25.4)
Dry Film Coverage, @ 1mil, ft <sup>2</sup> /gal, m <sup>2</sup> /litre	456 (11.2)	309 (7.6)	742 (18.2)	269 (6.6)	664 (16.3)	330 (8.1)
Application Temp F	50-90	50-90	50-90	50-90	50-90	50-90
Dry to Touch, hrs	1-2	1-2	1-2	1-2	1-2	1-2
Dry Handling, hrs	2-4	2-4	2-4	2-4	2-4	2-4
Recoat hrs (min/max)	1 / 24	1 / 24	1 / 24	1 / 24	1 / 24	1 / 24
Cure, min air set hrs	1	1	1	1	1	1
Cure, F/hrs	200/2 + 500/1	200/2 + 500/1	200/2 + 500/1	RT / 24	RT / 24	RT / 24
Flash Point, F(C)	> 212 (100)	> 212 (100)	> 212 (100)	> 212 (100)	> 212 (100)	> 212 (100)
VOC's, lbs/gal	0	0	0	0	0	0
Color	Light Gray	Aluminum	Black	Gray	Stainless Steel	White
Pot Life, hrs RT	NA	NA	NA	NA	NA	NA
Packaging	Pt, Qt, Gal, 5 Gal	Pt, Qt, Gal, 5 Gal	Pt, Qt, Gal, 5 Gal	Pt, Qt, Gal, 5 Gal	Pt, Qt, Gal, 5 Gal	Pt, Qt, Gal, 5 Gal
Price (Pt)	\$ 188.64	\$ 188.64	\$ 188.64	\$ 188.64	\$ 188.64	\$ 188.64

Shelf Life for all products is 6 months at room temperature

Storage temperature for all products is 40-85 °F

Primer for all products is not required except for exterior applications in which salt fog or moisture are present.

WFT = Wet Film Thickness

DFT = Recommended Dry Film Thickness

Dry Film Coverage numbers are theoretical: actual coverage will vary with material losses in mixing and application.

Please Note: These products are custom produced to order in small batches and all sales are final.

## Silicone Based

<b>High Temperature Silicone Based Corrosion Protection Coatings</b>						
<b>Part Number</b>	<b>UCCPC-12000</b>	<b>UCCPC-12030</b>	<b>UCCPC-12060</b>	<b>UCCPC-12120</b>	<b>UCCPC-12150</b>	<b>UCCPC-12180</b>
Type	Silicone	Silicone	Silicone	Silicone	Silicone	Silicone
Solids by Weight %	51.5	44.2	44.2	44.2	48.5	46.5
Solids by Volume %	38.1	41.6	38.2	46.1	39.5	38.3
Max Temp °F/°C	1100 (593)	1100 (593)	1100 (593)	1100 (593)	1100 (593)	1100 (593)
Specific Gravity	1.32	1.05	1.28	1.27	1.31	1.31
Mixed Viscosity, cP	400-800	200-600	400-800	400-900	500-750	750-950
Thinner	Distilled Water	Distilled Water	Distilled Water	Distilled Water	Distilled Water	Distilled Water
Components	1	1	1	1	1	1
Mix Ratio, by wt	N / A	N / A	N / A	N / A	N / A	N / A
WFT, mils (microns)	2.6 (66.5)	2.4 (61.0)	2.6 (66.4)	2.2 (55.1)	2.5 (64.3)	2.6 (66.3)
DFT, mils (microns)	1.0 (25.4)	1.0 (25.4)	1.0 (25.4)	1.0 (25.4)	1.0 (25.4)	1.0 (25.4)
Dry Film Coverage, @ 1mil, ft <sup>2</sup> /gal, m <sup>2</sup> /litre	611 (14.9)	668 (16.4)	613 (15.1)	740 (18.2)	634 (15.6)	614 (15.1)
Application Temp °F	50-120	50-120	50-120	50-120	50-120	50-120
Dry to Touch, hrs	1-2	1-2	1-2	1-2	1-2	1-2
Dry Handling, hrs	2-4	2-4	2-4	2-4	2-4	2-4
Recoat hrs (min/max)	1 / 24	1 / 24	1 / 24	1 / 24	1 / 24	1 / 24
Cure, min air set hrs	1	1	1	1	1	1
Cure, F/hrs	450/1 or 480/.75	450/1 or 480/.75	450/1 or 480/.75	450/1 or 480/.75	450/1 or 480/.75	450/1 or 480/.75
Flash Point, F(C)	> 212 (100)	> 212 (100)	> 212 (100)	> 212 (100)	> 212 (100)	> 212 (100)
VOC's, lbs/gal	1.04	0.86	0.99	0.98	0.98	0.98
Color	Flat Black	Aluminum	Gray	White	Green	Red
Pot Life, hrs RT	NA	NA	NA	NA	NA	NA
Packaging	Pt, Qt, Gal, 5 Gal	Pt, Qt, Gal, 5 Gal	Pt, Qt, Gal, 5 Gal	Pt, Qt, Gal, 5 Gal	Pt, Qt, Gal, 5 Gal	Pt, Qt, Gal, 5 Gal
Price (Pt)	\$ 188.64	\$ 188.64	\$ 188.64	\$ 188.64	\$ 188.64	\$ 188.64

Shelf Life for all products is 6 months at room temperature

Storage temperature for all products is 55-85 °F

Primer for all products is not required except for exterior applications in which salt fog or moisture are present.

WFT = Wet Film Thickness

DFT = Recommended Dry Film Thickness

Dry Film Coverage numbers are theoretical: actual coverage will vary with material losses in mixing and application.

Please Note: These products are custom produced to order in small batches and all sales are final.

### Silicone Based - Continued

<b>High Temperature Silicone Based Corrosion Protection Coatings</b>					
<b>Part Number</b>	<b>UCCPC-12210</b>	<b>UCCPC-12240</b>	<b>UCCPC-12270</b>	<b>UCCPC-12285</b>	<b>UCCPC-15000</b>
Type	Silicone	Silicone	Silicone	Silicone	Inorganic
Solids by Weight %	44.8	47.0	44.5	44.5	76.7
Solids by Volume %	38.5	38.0	37.8	37.8	36.8
Max Temp °F/°C	1100 (593)	1100 (593)	1100 (593)	1100 (593)	900 (482)
Specific Gravity	1.25	1.33	1.32	1.32	3.27
Mixed Viscosity, cP	300-600	500-700	300-500	500-700	1250-1750
Thinner	Distilled Water	Distilled Water	Distilled Water	Distilled Water	Distilled Water
Components	1	1	1	1	2
Mix Ratio, by wt	N / A	N / A	N / A	N / A	2:1
WFT, mils (microns)	2.6 (66.3)	2.6 (66.8)	2.7 (67.2)	2.6 (64.9)	2.7 (69.1)
DFT, mils (microns)	1.0 (25.4)	1.0 (25.4)	1.0 (25.4)	1.0 (25.4)	1.0 (25.4)
Dry Film Coverage, @ 1mil, ft <sup>2</sup> /gal, m <sup>2</sup> /litre	617 (15.2)	610 (15.0)	606 (14.9)	628 (15.4)	589 (14.5)
Application Temp °F	50-120	50-120	50-120	50-120	50-90
Dry to Touch, hrs	1-2	1-2	1-2	1-2	1-2
Dry Handling, hrs	2-4	2-4	2-4	2-4	2-4
Recoat hrs (min/max)	1 / 24	1 / 24	1 / 24	1 / 24	4 / 24
Cure, min air set hrs	1	1	1	1	1
Cure, F/hrs	450/1 or 480/.75	450/1 or 480/.75	450/1 or 480/.75	450/1 or 480/.75	200/2
Flash Point, F(C)	> 212 (100)	> 212 (100)	> 212 (100)	> 212 (100)	N/A
VOC's, lbs/gal	1.01	0.95	0.98	0.98	0.00
Color	Blue	Yellow	Brown	Orange	Zinc
Pot Life, hrs RT	NA	NA	NA	NA	<24
Packaging	Pt, Qt, Gal, 5 Gal	Pt, Qt, Gal, 5 Gal	Pt, Qt, Gal, 5 Gal	Pt, Qt, Gal, 5 Gal	Pt, Qt, Gal, 5 Gal
Price (Pt)	\$ 188.64	\$ 188.64	\$ 188.64	\$ 188.64	\$ 188.64

Shelf Life for all products is 6 months at room temperature

Storage temperature for all products is 55-85 °F

Primer for all products is not required except for exterior applications in which salt fog or moisture are present.

WFT = Wet Film Thickness

DFT = Recommended Dry Film Thickness

Dry Film Coverage numbers are theoretical: actual coverage will vary with material losses in mixing and application.

Please Note: These products are custom produced to order in small batches and all sales are final.

## Silicone-Polyester Based

<b>High Temperature Silicone Polyester Based Corrosion Protection Coatings</b>					
<b>Part Number</b>	<b>UCCPC-12000-S</b>	<b>UCCPC-12030-S</b>	<b>UCCPC-12060-S</b>	<b>UCCPC-12120-S</b>	<b>UCCPC-12150-S</b>
Type	Silicone-Polyester	Silicone-Polyester	Silicone-Polyester	Silicone-Polyester	Silicone-Polyester
Solids by Weight %	69.9	37.0	62.1	42.1	62.1
Solids by Volume %	57.7	36.7	58.5	49.2	57.4
Max Cont Temp °F/°C	600 (316)	600 (316)	600 (316)	600 (316)	600 (316)
Max Int Temp °F/°C	800 (427)	800 (427)	800 (427)	800 (427)	800 (427)
Specific Gravity	1.45	1.00	1.42	1.37	1.46
Mixed Viscosity, cP	400-600	300-400	200-400	300-500	250-350
Thinner	PM Acetate	PM Acetate	PM Acetate	PM Acetate	PM Acetate
Components	1	1	1	1	1
Mix Ratio, by wt	N / A	N / A	N / A	N / A	N / A
WFT, mils (microns)	1.73 (44.0)	2.73 (69.2)	1.71 (43.4)	2.03 (51.6)	1.74 (44.3)
DFT, mils (microns)	1.0 (25.4)	1.0 (25.4)	1.0 (25.4)	1.0 (25.4)	1.0 (25.4)
Dry Film Coverage, @ 1mil, ft <sup>2</sup> /gal, m <sup>2</sup> /litre	925 (22.7)	589 (14.5)	938 (23.0)	789 (19.4)	920 (22.6)
Application Temp °F	50-120	50-120	50-120	50-120	50-120
Dry to Touch, hrs	1-2	1-2	1-2	1-2	1-2
Dry Handling, hrs	2-4	2-4	2-4	2-4	2-4
Recoat hrs (min/max)	1 / 24	1 / 24	1 / 24	1 / 24	1 / 24
Min air set hrs	1	1	1	1	1
Cure, F/hrs	450/1 or 480/.75	450/1 or 480/.75	450/1 or 480/.75	450/1 or 480/.75	450/1 or 480/.75
Flash Point, F(C)	118 (48)	115 (46)	115 (46)	115 (46)	115 (46)
VOC's, lbs/gal	3.6	5.3	3.6	3.4	3.7
Color	Black	Aluminum	Gray	White	Green
Pot Life, hrs RT	NA	NA	NA	NA	<24
Packaging	Pt, Qt, Gal, 5 Gal	Pt, Qt, Gal, 5 Gal	Pt, Qt, Gal, 5 Gal	Pt, Qt, Gal, 5 Gal	Pt, Qt, Gal, 5 Gal
Price (Pt)	\$ 227.86	\$ 227.86	\$ 227.86	\$ 227.86	\$ 227.86

Shelf Life for all products is 6 months at room temperature

Storage temperature for all products is 40-90 °F

Primer for all products is not required except for exterior applications in which salt fog or moisture are present.

WFT = Wet Film Thickness

DFT = Recommended Dry Film Thickness

Dry Film Coverage numbers are theoretical: actual coverage will vary with material losses in mixing and application.

Please Note: These products are custom produced to order in small batches and all sales are final.

### Silicone-Polyester Based - Continued

<b>High Temperature Silicone Polyester Based Corrosion Protection Coatings</b>					
<b>Part Number</b>	<b>UCCPC-12180-S</b>	<b>UCCPC-12210-S</b>	<b>UCCPC-12240-S</b>	<b>UCCPC-12270-S</b>	<b>UCCPC-12285-S</b>
Type	Silicone-Polyester	Silicone-Polyester	Silicone-Polyester	Silicone-Polyester	Silicone-Polyester
Solids by Weight %	62.1	62.1	62.1	62.1	62.1
Solids by Volume %	57.4	59.0	57.7	58.6	58.9
Max Cont Temp °F/°C	600 (316)	600 (316)	600 (316)	600 (316)	600 (316)
Max Int Temp °F/°C	800 (427)	800 (427)	800 (427)	800 (427)	800 (427)
Specific Gravity	1.47	1.43	1.40	1.45	1.40
Mixed Viscosity, cP	500-700	150-250	300-500	400-600	550-750
Thinner	PM Acetate	PM Acetate	PM Acetate	PM Acetate	PM Acetate
Components	1	1	1	1	1
Mix Ratio, by wt	N / A	N / A	N / A	N / A	N / A
WFT, mils (microns)	1.74 (44.3)	1.69 (43.0)	1.73 (44.0)	1.71 (43.3)	1.70 (43.2)
DFT, mils (microns)	1.0 (25.4)	1.0 (25.4)	1.0 (25.4)	1.0 (25.4)	1.0 (25.4)
Dry Film Coverage, @ 1mil, ft <sup>2</sup> /gal, m <sup>2</sup> /litre	921 (22.6)	946 (23.2)	925 (22.7)	940 (23.1)	944 (23.2)
Application Temp °F	50-120	50-120	50-120	50-120	50-120
Dry to Touch, hrs	1-2	1-2	1-2	1-2	1-2
Dry Handling, hrs	2-4	2-4	2-4	2-4	2-4
Recoat hrs (min/max)	1 / 24	1 / 24	1 / 24	1 / 24	1 / 24
Min air set hrs	1	1	1	1	1
Cure, F/hrs	450/1 or 480/.75	450/1 or 480/.75	450/1 or 480/.75	450/1 or 480/.75	450/1 or 480/.75
Flash Point, F(C)	115 (46)	115 (46)	115 (46)	115 (46)	115 (46)
VOC's, lbs/gal	3.7	3.6	3.7	3.6	3.6
Color	Red	Blue	Yellow	Brown	Orange
Pot Life, hrs RT	NA	NA	NA	NA	NA
Packaging	Pt, Qt, Gal, 5 Gal	Pt, Qt, Gal, 5 Gal	Pt, Qt, Gal, 5 Gal	Pt, Qt, Gal, 5 Gal	Pt, Qt, Gal, 5 Gal
Price (Pt)	\$ 227.86	\$ 227.86	\$ 227.86	\$ 227.86	\$ 227.86

Shelf Life for all products is 6 months at room temperature  
 Storage temperature for all products is 40-90 °F  
 Primer for all products is not required except for exterior applications in which salt fog or moisture are present.

WFT = Wet Film Thickness  
 DFT = Recommended Dry Film Thickness  
 Dry Film Coverage numbers are theoretical: actual coverage will vary with material losses in mixing and application.

Please Note: These products are custom produced to order in small batches and all sales are final.



## High Temperature Silicone-Ceramic Adhesive & Potting Compound 900°F / 482°C

### FlameShield™ UC-2715 Adhesive Potting Compound



- Silicone Bonded – Ceramic Filled.
- Useable to 900°F / 482°C.
- Excellent Moisture Resistance.
- Used to seal and pot electronic components such as power resistors and cartridge heaters.
- Ships as Hazardous.

FlameShield™ UC-2715 Silicone-Ceramic Adhesive & Potting Compound		
Part Number	Quantity	Price
UC-2715-16	16 oz (Pint)	\$ 232.75
UC-2715-32	32 oz (Quart)	\$ 342.50
UC-2715-128	128 oz (Gallon)	\$ 610.00
UC-2715-640	640 oz (5 Gallon)	\$ 2800.17

<b>Primary Component:</b>	Fused Silica - Silicone
<b>Max continuous temperature:</b>	900°F / 482°C
<b>Dielectric Strength, volts/mil:</b>	>250
<b>Moisture resistance:</b>	Excellent
<b>Porosity After 900F, %:</b>	<1.0%
<b>Shrinkage, % at 900F:</b>	<1%
<b>Color:</b>	White
<b>No. Of Components:</b>	2
<b>Mix Ratio, powder:liquid:</b>	2.4:1
<b>Mixed Viscosity, cP:</b>	Paste
<b>Recommended Cure:</b>	16-24 Hours @ room temperature +30 min @ 150°-450°F

Please Note: These products are custom produced to order in small batches and all sales are final.

**High Temperature, Heat, Flame, Fire, Molten Metal & Weld Splatter Protection Materials**

*Fax Orders: 610-340-9054 Telephone Orders: 610-906-3549 orders@abthermal.com*

---

---

## **Section 12**

### **Metal Foils**

- Stainless Steel 304 / 309 / 321

**High Temperature, Heat, Flame, Fire, Molten Metal & Weld Splatter Protection Materials**

*Fax Orders: 610-340-9054 Telephone Orders: 610-906-3549 [orders@abthermal.com](mailto:orders@abthermal.com)*

---

---



**Stainless Steel Foil**  
 304 / 309 / 321



Stainless steel foils can be used to form shields and barriers for protection of equipment in high heat environments.

Stainless steel foil is also excellent as a tool wrap, to protect tools from environmental factors. Resistant to corrosion and staining. Used to protect machine tools during heat treatment operations.

Stainless steel foil rolls are .002" thick by 24" wide. The cores are 3" ID. Available roll length is 50 feet and 100 feet.

Certification is available.

Maximum continuous temperature ratings:  
 304 Annealed Stainless Steel: 1800°F  
 321 Annealed Stainless Steel: 2000°F  
 309 Annealed Stainless Steel: 2240°F

<b>FlameShield™ Stainless Steel Foil</b>		
<b>Part Number</b>	<b>Size</b>	<b>Price</b>
FOIL-SS-304-M00005-002-24-50	.002 x 24" x 50'	\$ 264.34
FOIL-SS-304-M00005-002-24-100	.002 x 24" x 100'	\$ 428.47
FOIL-SS-309-M00005-002-24-50	.002 x 24" x 50'	\$ 298.61
FOIL-SS-321-M00005-002-24-50	.002 x 24" x 50'	\$ 219.83
FOIL-SS-321-M00005-002-24-100	.002 x 24" x 100'	\$ 418.53



### 309 Stainless Steel Foil - Embossed / Dimpled

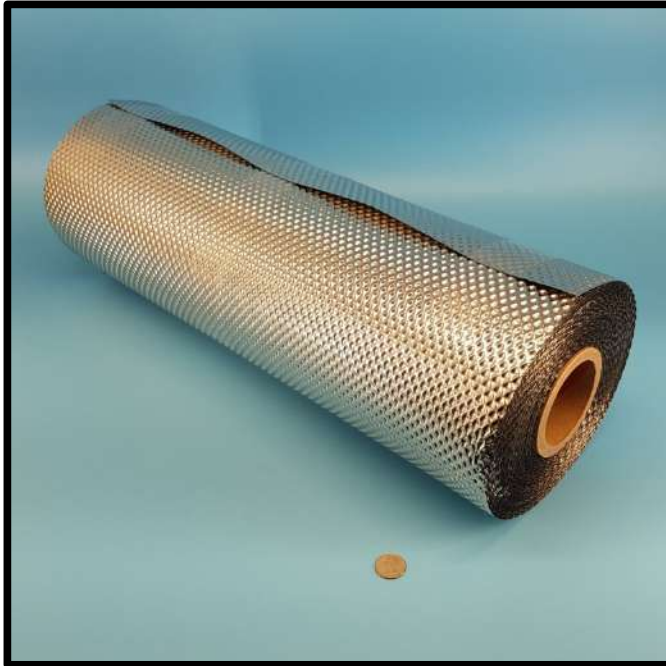

Stainless steel embossed or dimpled foil is a flexible material to use on removeable blankets and shields. Popular on engine exhaust systems as a contact shield covering hot piping.

Unlike plain foil, it does not easily crease and can be flexed without it taking a set.

Stainless steel foil rolls are .002" thick by 24" wide. Maximum length is 150 feet.

The roll core is 3" ID.

Available by the foot, metre or roll.

Certification is available.



FlameShield™ Stainless Steel 309 Foil Embossed/Dimpled		
Part Number	Size	Price
FOIL-SS-309EMB-002-24-150	.002 x 24" x 150'	\$ 2117.56
FOIL-SS-309EMB-002-24-FT-X	.002 x 24" x 1'	\$ 22.44
FOIL-SS-309EMB-002-24-M-X	.002 x 24" x 1 metre	\$ 73.61

For the "X" value, specify the length in feet or metres



**Intentionally Blank**